



Renault ALASKAN

Vehicle user manual



A passion for performance



ELF, partner of
**World
Series**
by RENAULT



RENAULT recommends ELF

Partners in cutting-edge automotive technology, Elf and Renault combine their expertise on both the racetrack and the city streets. This enduring partnership gives drivers a range of lubricants perfectly suited to Renault cars. Lasting protection and optimum performance for your engine – guaranteed. Whether changing the oil or simply topping up, to find the approved ELF lubricant best suited to your vehicle, ask your Renault dealer for a recommendation or consult your vehicle maintenance handbook.



www.lubricants.elf.com



A brand from **TOTAL**

Foreword

This handbook was prepared to help you understand the operation and maintenance of your vehicle so that you may enjoy many kilometres (miles) of driving pleasure. Please read through this handbook before operating your vehicle.

A separate Warranty Information & Maintenance Booklet explains in detail the warranty coverage that applies to your vehicle.

Your approved dealer knows your vehicle best. When you require any service or have any questions, your approved dealer will be glad to assist you with the extensive resources available for you.

IMPORTANT SAFETY INFORMATION REMINDERS!

Follow these important driving rules to help ensure a safe and complete trip for you and your passengers!

NEVER drive under the influence of alcohol or drugs.

ALWAYS observe posted speed limits and never drive too fast for conditions.

ALWAYS give your full attention to driving and avoid using vehicle features or taking other actions that could distract you.

ALWAYS use your seat belts and appropriate child restraint systems. Pre-teen children should be seated in the rear seat.

ALWAYS provide information about the proper use of vehicle safety features to all occupants of the vehicle.

ALWAYS review this Driver's handbook for important safety information.

WHEN READING THE HANDBOOK

This handbook includes information for all options available on this model. Therefore, you may find some information that does not apply to your vehicle.

Throughout this handbook, some illustrations may only show the layout for Left-Hand Drive (LHD) models. For Right-Hand Drive (RHD) models, the illustrated shape and location of some components may differ.

All information, specifications and illustrations in this handbook are those in effect at the time of printing. RENAULT reserves the right to change specifications or designs at any time without notice and without obligation.

MODIFICATION OF YOUR VEHICLE

This vehicle cannot be modified without taking into consideration the RENAULT "Bodybuilders Standards for Assembly, Equipment and Conversion" that has been written for this purpose. All modifications done which do not follow the instructions in that document could affect the vehicle functioning and its lifetime. Furthermore, failure to comply with these Standards may arise in security

problems and could even result in prosecution. Damages or failures in the vehicle as a consequence of modifications may not be covered under RENAULT warranty.

READ FIRST — THEN DRIVE SAFELY

Before driving your vehicle, read this Driver's handbook carefully. This will ensure familiarity with controls and maintenance requirements, assisting you in the safe operation of your vehicle.

Throughout this handbook the following symbols and words are used:



WARNING

Indicates the presence of a hazard that could cause death or serious personal injury. To avoid or reduce the risk, the procedures described must be followed precisely.

CAUTION

Indicates the presence of a hazard that could cause minor or moderate personal injury, or damage to your vehicle. To avoid or reduce the risk, the procedures described must be followed carefully.

NOTE

Indicates additional helpful information.

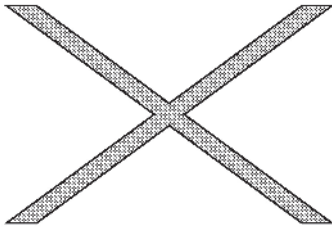

This symbol means “Do not do this” or “Do not let this happen”.



Arrows in an illustration that are similar to these point to the front of the vehicle.



Arrows in an illustration that are similar to these indicate movement or action.



Arrows in an illustration that are similar to these call attention to an item in the illustration.

[]:

Square brackets are used to indicate messages, keys, or items displayed on a screen.

< >:

Chevrons or angle brackets are used to indicate texts on controls like buttons or switches inside or on the vehicle.

Air bag warning labels:



“NEVER use a rearward facing child restraint on a seat protected by an ACTIVE AIRBAG in front of it, DEATH or SERIOUS INJURY to the CHILD can occur.”

Be sure to read the “Air bag warning labels” description in the Safety section of this handbook; and the “Air bag label” description at the end of this handbook.

ON-PAVEMENT AND OFF-ROAD DRIVING (4WD models)

This vehicle will handle and manoeuvre differently from an ordinary passenger vehicle, because it has a higher centre of gravity. As with other vehicles with features of this type, failure to operate this vehicle correctly may result in loss of control or an accident.

Be sure to read “On-pavement and off-road driving precautions” and “Four-wheel drive (4WD)” in the “5. Starting and driving” section of this handbook.

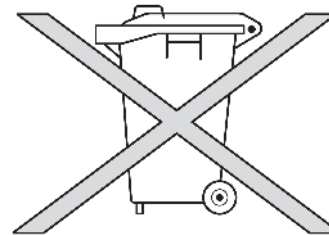

BATTERY DISPOSAL

CAUTION

An improperly disposed battery can harm the environment. Always confirm local regulations for battery disposal.

Examples of the batteries that the vehicle contains:

Vehicle battery

Remote controller battery (for Remote Control Key and/or Remote keyless entry system)

Tyre Pressure Monitoring System (TPMS) sensor battery

Remote controller battery (for Mobile Entertainment system)

If in doubt, contact your local authority, or approved dealer, or a qualified workshop for advice on disposal.



Bluetooth® is a trademark owned by Bluetooth SIG, Inc. and licensed to Visteon Corporation.



iPod® is a trademark of Apple Inc.



Gracenote® and CDDB are registered trademarks of Gracenote, Inc. The Gracenote logo and logo type, and the "Powered by Gracenote" logo are trademarks of Gracenote.

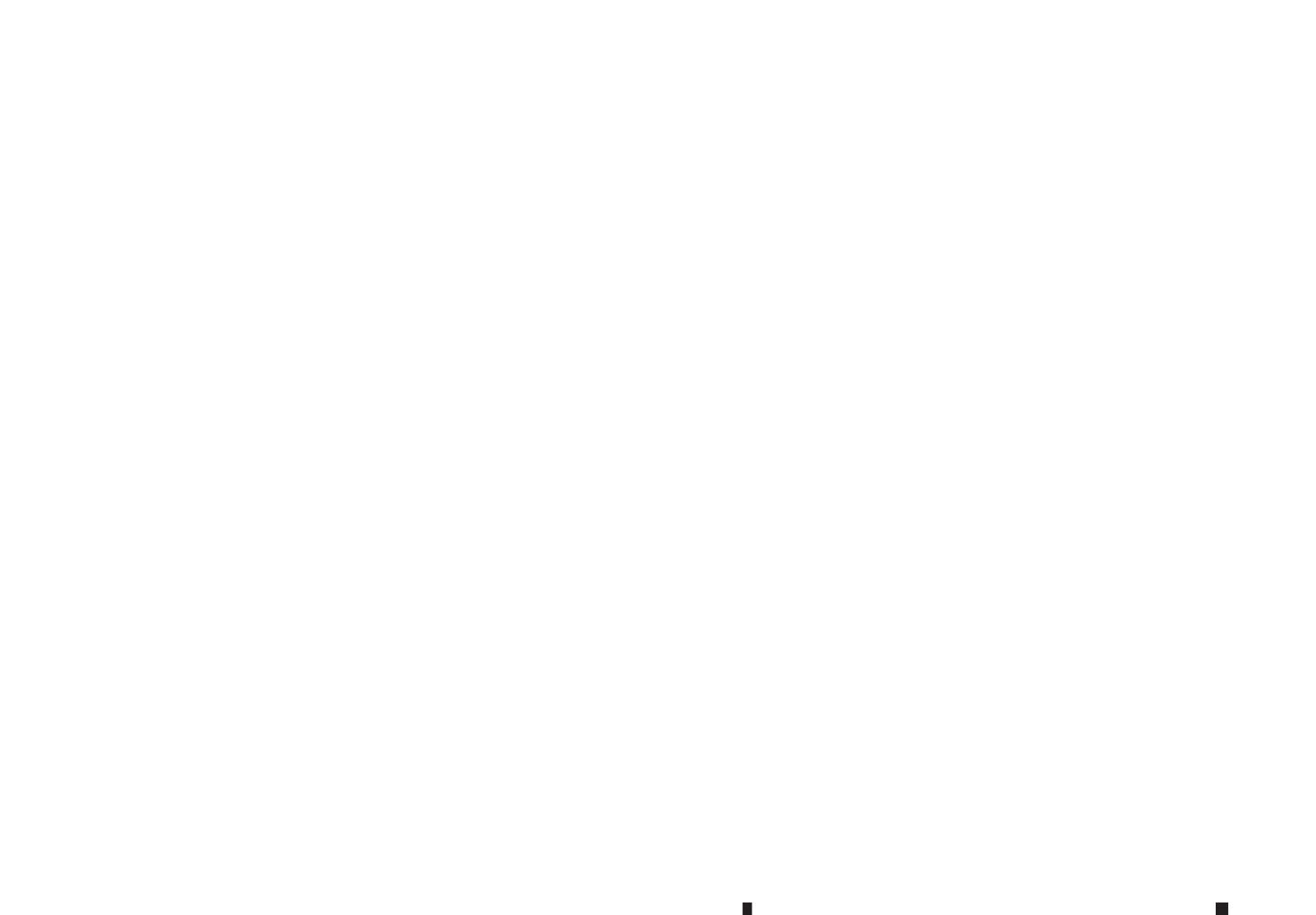

Contents

Illustrated table of contents	0
Safety — seats, seat belts and supplemental restraint system	1
Instruments and controls	2
Pre-driving checks and adjustments	3
Display screen, heater and air conditioner, and audio system	4
Starting and driving	5
In case of emergency	6
Appearance and care	7
Maintenance and do-it-yourself	8
Technical information	9
Index	10

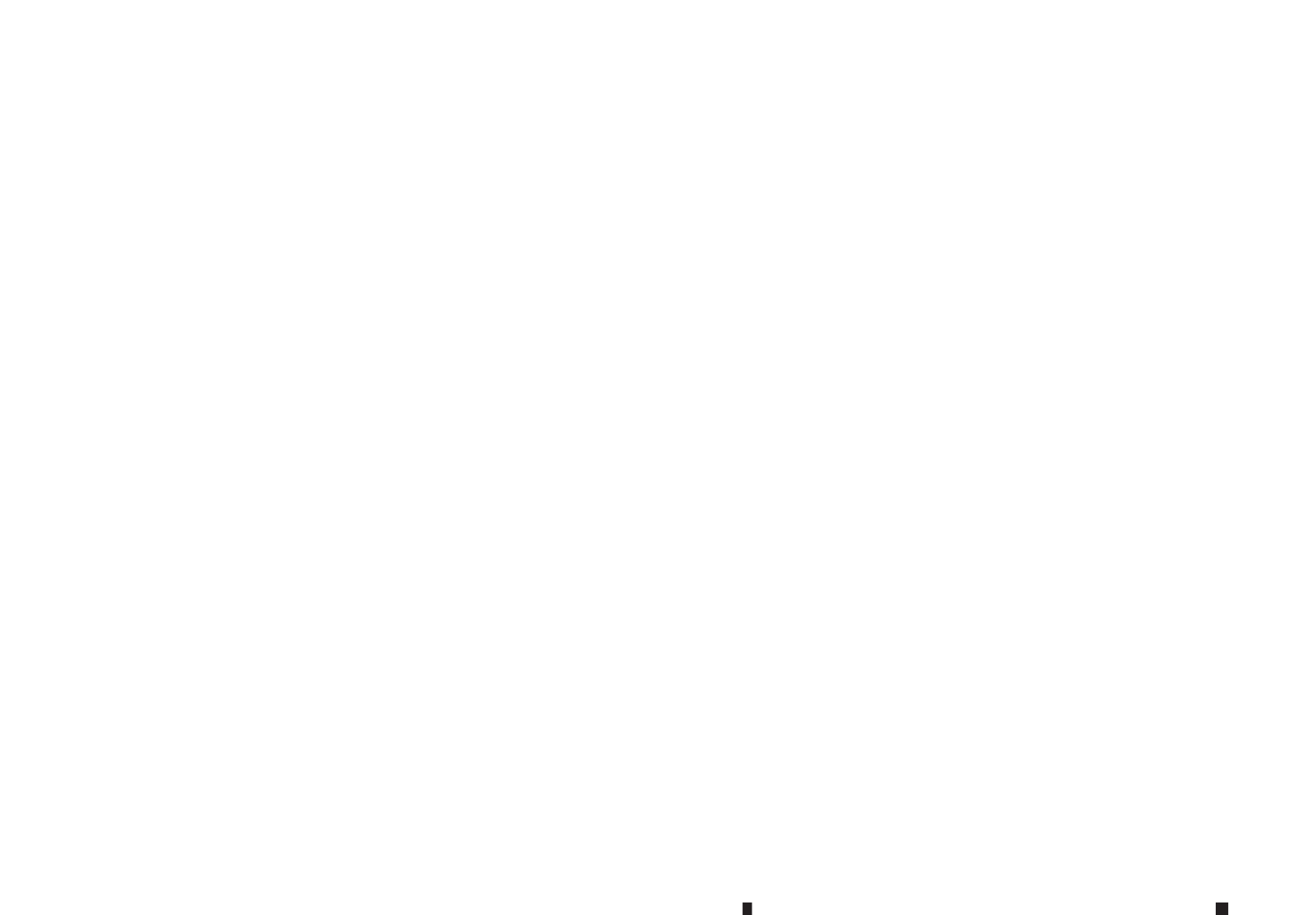

0 Illustrated table of contents

Seats, seat belts and Supplemental Restraint System (SRS).....	0-2	Right-Hand Drive (RHD) model	0-7
Exterior front.....	0-3	Instrument panel	0-8
Exterior rear	0-4	Left-Hand Drive (LHD) model.....	0-8
Passenger compartment.....	0-5	Right-Hand Drive (RHD) model.....	0-9
Cockpit.....	0-6	Meters and gauges.....	0-10
Left-Hand Drive (LHD) model	0-6	Engine compartment.....	0-11
		M9T 2.3DCI engine	0-11

SEATS, SEAT BELTS AND SUPPLEMENTAL RESTRAINT SYSTEM (SRS)

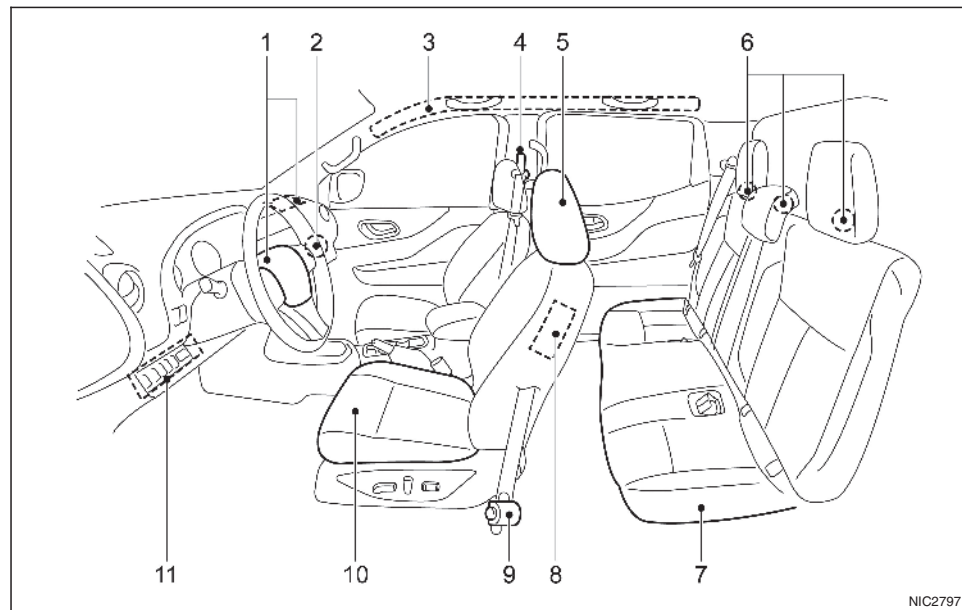

*: where fitted

- | | |
|---------------------------------------------------------|-----------------------------------------------------------------------------------|
| 1. Supplemental front-impact air bags* (P. 1-29) | 6. Child restraint anchor point* (for top tether strap child restraint) (P. 1-21) |
| 2. Front passenger air bag switch* (P. 1-37) | 7. Rear seats* (P. 1-5) or Jump seat* (P. 1-6) |
| 3. Supplemental curtain side-impact air bags* (P. 1-30) | 8. Supplemental side-impact air bags* (P. 1-29) |
| 4. Seat belts (P. 1-9) | 9. Pre-tensioner seat belt system* (P. 1-33) |
| 5. Head restraints (P. 1-6) | 10. Front seats (P. 1-2) |
| | 11. Supplemental driver's knee air bag* (P. 1-29) |

EXTERIOR FRONT

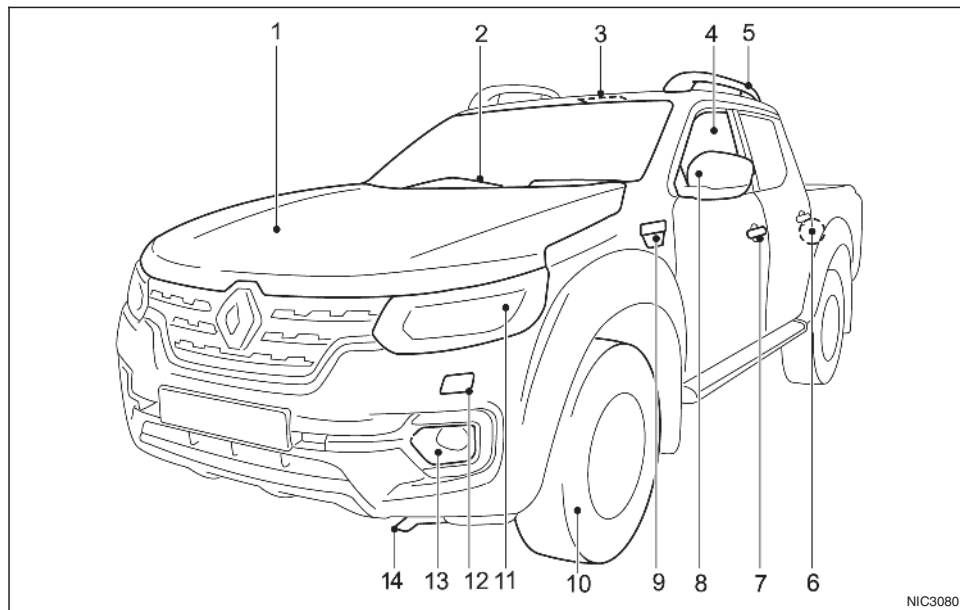

1. Bonnet (P. 3-17)

2. Windscreen wipers and washers
– Switch operation (P. 2-29)
– Wiper blade replacement (P. 8-16)
– Window washer fluid (P. 8-11)

3. Sunroof*1 (P. 2-37)

4. Windows (P. 2-31)

5. Roof rail*1 (P. 2-35)

6. Child safety rear door locks*1 (P. 3-5)

7. Doors
– Keys (P. 3-2)
– Door locks (P. 3-4)
– Remote keyless entry system*1 (P. 3-6)
– Remote Control Key system*1 (P. 3-7)
– Security system*1 (P. 3-15)

8. Outside rearview mirrors (P. 3-25)

9. Side turn signal lights
– Bulb replacement (P. 8-24)

10. Tyres
– Tyres and wheels (P. 8-27)
– Flat tyre (P. 6-2)
– Specifications (P. 9-4)
– Four-Wheel Drive (4WD)*1 (P. 5-25)

11. Headlights and turn signal lights
– Switch operation (P. 2-26)
– Bulb replacement (P. 8-21)

12. Headlight cleaner*1
– Operation (P. 2-30)

13. Front fog lights*1 or Daytime running lights*1
– Switch operation (P. 2-28, P. 2-27)
– Bulb replacement (P. 8-24)

14. Towing eye*2 (P. 6-14)

*1: where fitted

*2: The layout illustrated is for the Right-Hand Drive (RHD) model. On the Left-Hand Drive (LHD) model, the towing eye is located on the opposite side.

EXTERIOR REAR

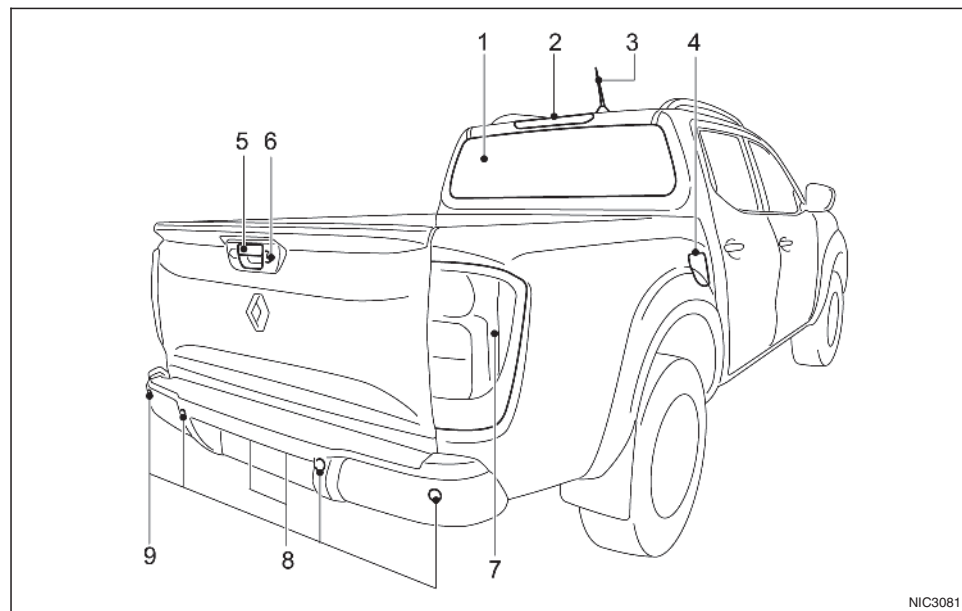

- | | |
|------------------------------------------------------|------------------------------------------------------------|
| 1. Rear window defogger* (P. 2-29) | 7. Rear combination lights (bulb replacement)
(P. 8-24) |
| 2. High-mounted stop light* (P. 5-42) | 8. Number plate lights (bulb replacement)
(P. 8-24) |
| 3. Antenna* (P. 4-32) | 9. Parking sensor (sonar)* (P. 5-39) |
| 4. AdBlue filler lid (P. 3-19) | *: where fitted |
| 5. Rear view camera*
— Reversing camera* (P. 4-7) | |
| 6. Cargo bed* (P. 3-20) | |

PASSENGER COMPARTMENT

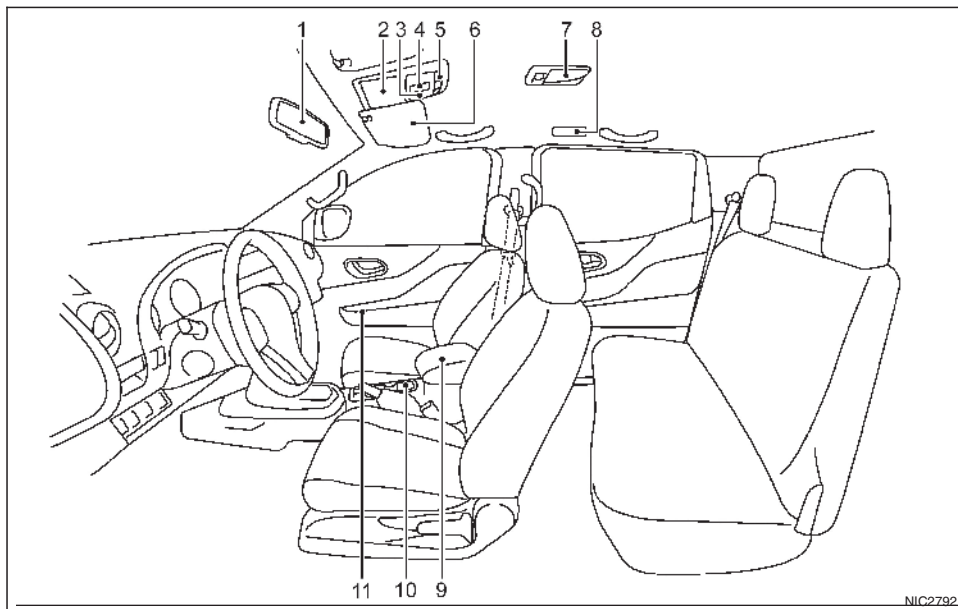

1. Inside rearview mirror (P. 3-23)
2. Sunglasses holder (P. 2-34)
3. Microphone*
 - Bluetooth® Hands-Free Phone System* (P. 4-55, P. 4-61)
4. Sunroof switch* (P. 2-37)
5. Map lights (P. 2-38)
6. Sun visors (P. 2-36)
7. Room light* (P. 2-39)
8. Rear personal light* (P. 2-39)
9. Console box* (P. 2-35)
 - Power outlet (P. 2-33)
10. Cup holders* (P. 2-35)

11. Door armrest
 - Power window controls* (P. 2-31)
 - Power door lock switch (driver's door)* (P. 3-4)
 - Outside rearview mirror remote control switch (driver's door)* (P. 3-25)

*: where fitted

COCKPIT

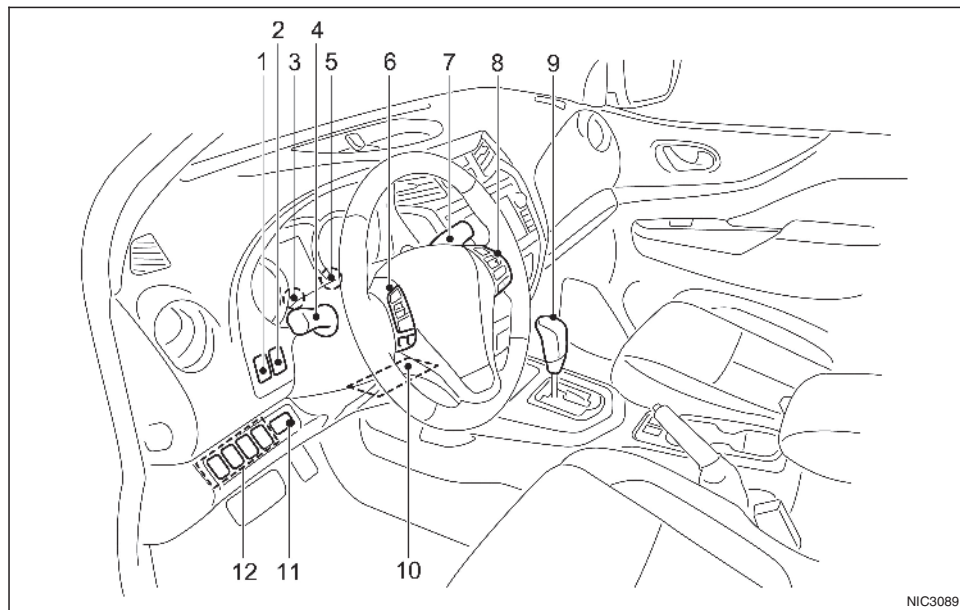

LEFT-HAND DRIVE (LHD) MODEL

1. Instrument brightness control switch (P. 2-4)
2. <TRIP RESET> switch for twin trip odometer (P. 2-17)
3. Instrument brightness control switch (P. 2-4)

4. Headlight, fog light, and turn signal switch
 - Headlight (P. 2-26)
 - Fog light* (P. 2-28)
 - Turn signal (P. 2-27)
5. Twin trip odometer (P. 2-27)
6. Steering-wheel-mounted controls* (left side)
 - Audio control steering switch* (P. 4-54)

7. Wiper and washer switch (P. 2-29)
 8. Steering-wheel-mounted controls* (right side)
 - Cruise control system* (P. 5-33)
 - Speed limiter system* (P. 5-35)
 - Hands-Free Phone System switch* (P. 4-55, P. 4-62)
 9. Shift lever
 - Automatic Transmission (AT) (P. 5-13)
 - Manual Transmission (MT) (P. 5-16)
 10. Tilting steering wheel lever* (P. 3-23)
 11. Fuel filler lid opener switch (P. 3-18)
 12. — Parking sensor (sonar) system off switch* (P. 5-39)
 - Active Emergency Braking system off switch* (P. 5-29)
 - Electronic Stability Programme (ESP) OFF switch (P. 5-27)
 - Headlight cleaner switch* (P. 2-30)
 - Stop/Start OFF switch* (P. 5-17)
 - Headlight aiming control* (P. 2-27)
- *: where fitted

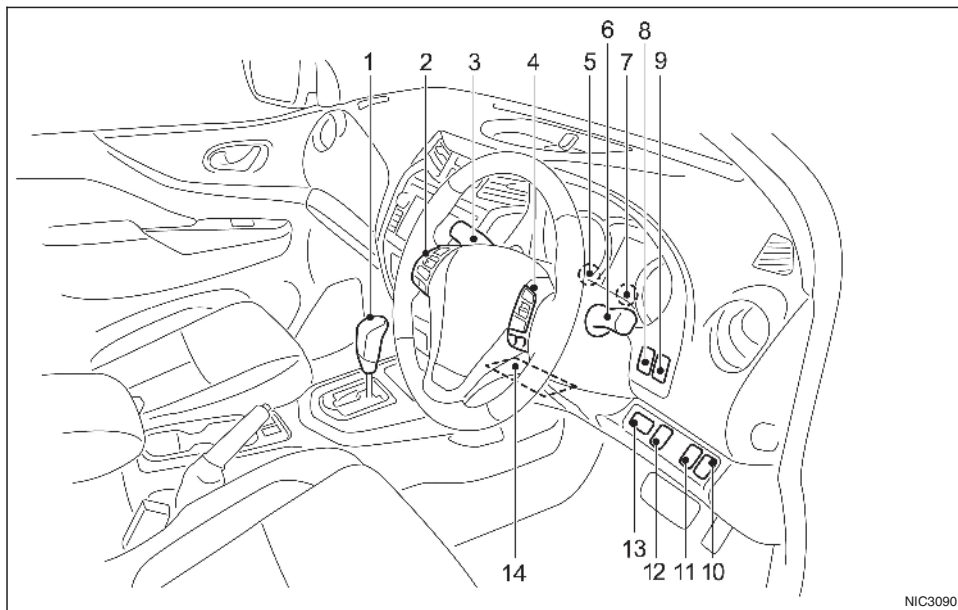

6. Headlight, fog light, and turn signal switch
 - Headlight (P. 2-26)
 - Fog light* (P. 2-28)
 - Turn signal (P. 2-27)
 7. Twin trip odometer (P. 2-17)
 8. <TRIP RESET> switch for twin trip odometer (P. 2-17)
 9. Instrument brightness control switch (P. 2-4)
 10. — Headlight aiming control* (P. 2-27)
 - Stop/Start OFF switch* (P. 5-17)
 11. Electronic Stability Programme (ESP) OFF switch* (P. 5-27)
 12. — Parking sensor (sonar) system off switch* (P. 5-39)
 - Active Emergency Braking system off switch* (P. 5-29)
 13. Fuel filler lid opener switch (P. 3-18)
 14. Tilting steering wheel lever* (P. 3-23)
- *: where fitted

RIGHT-HAND DRIVE (RHD) MODEL

1. Shift lever
 - Automatic Transmission (AT) (P. 5-13)
 - Manual Transmission (MT) (P. 5-16)
2. Steering-wheel-mounted controls* (left side)
 - Audio control steering switch* (P. 4-54)
 - Vehicle information display control switch* (P. 2-13)
3. Wiper and washer switch (P. 2-29)
4. Steering-wheel-mounted controls* (right side)
 - Cruise control system* (P. 5-33)
 - Speed limiter system* (P. 5-35)
 - Hands-Free Phone System switch* (P. 4-55, P. 4-62)
5. Instrument brightness control switch (P. 2-4)

INSTRUMENT PANEL

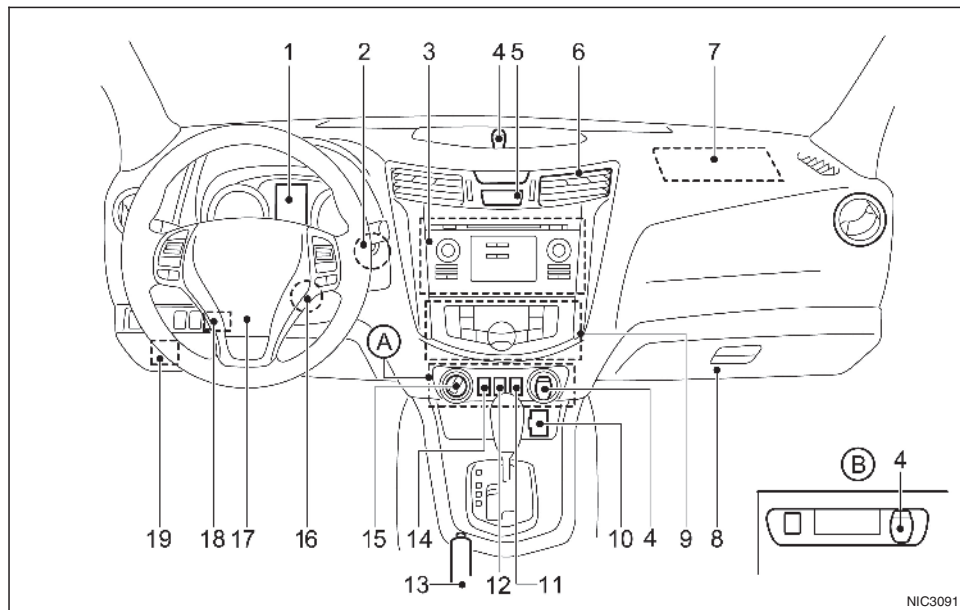

10. USB (Universal Serial Bus) connection port (P. 4-33)/iPod connection port (P. 4-41)
– Auxiliary (AUX) input jack (P. 4-33)
 11. Power door lock switch* (P. 3-4)
 12. Hill descent control switch* (P. 5-31)
 13. Parking brake
– Operation (P. 3-26)
– Check (P. 8-9)
 14. Differential lock mode switch* (P. 5-26)
 15. Four-Wheel Drive (4WD) mode switch* (P. 5-20)
 16. Ignition switch (models without Remote Control Key system) (P. 5-8)
 17. Steering wheel
– Horn (P. 2-31)
– Driver's supplemental front-impact air bag* (P. 1-29)
– Power steering system (P. 5-42)
 18. Fuel filler lid release (P. 3-18)
 19. Bonnet release handle (P. 3-17)
- Ⓐ: 4WD models
Ⓑ: 2WD models
*: where fitted
**: See the separate Touchscreen Navigation Owner's Manual (where fitted).

LEFT-HAND DRIVE (LHD) MODEL

1. Meters and gauges (P. 2-2)
– Vehicle information display (P. 2-12)
2. Push-button ignition switch (models with Remote Control Key system) (P. 5-10)
3. Audio system* (P. 4-29) or Navigation system**
– Reversing camera* (P. 4-7)
– 360° Camera* (P. 4-11)
4. Power outlet (P. 2-33)
5. Hazard warning flasher switch (P. 6-2)
6. Centre vent (P. 4-19)
7. Front passenger's supplemental front-impact air bag* (P. 1-29)
8. Glove box (P. 2-34)
9. Heater and air conditioner control (P. 4-20)

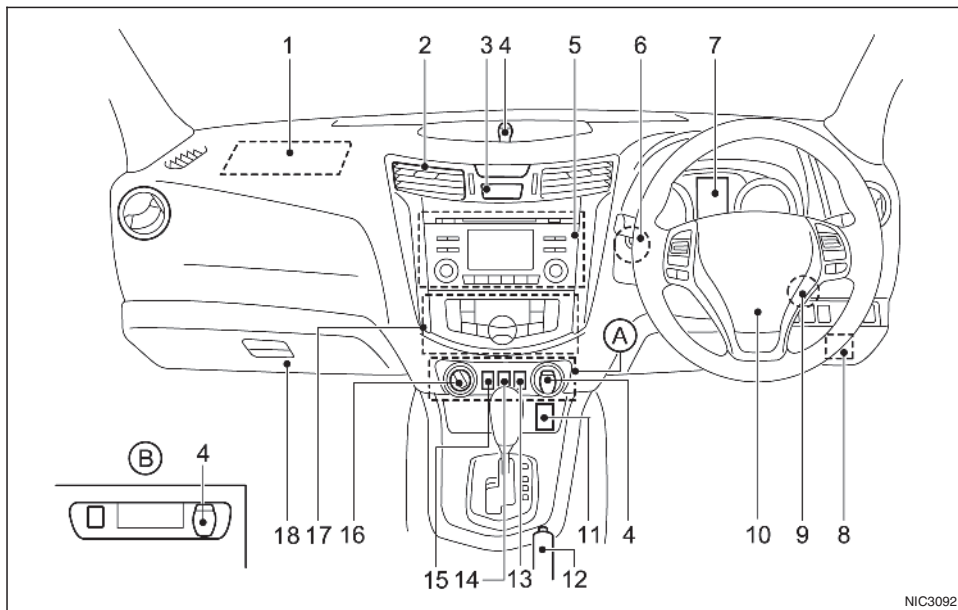

RIGHT-HAND DRIVE (RHD) MODEL

1. Front passenger's supplemental front-impact air bag* (P. 1-29)
2. Centre vent (P. 4-19)
3. Hazard warning flasher switch (P. 6-2)
4. Power outlet (P. 2-33)

5. Audio system* (P. 4-29) or Navigation system**
 - Reversing camera* (P. 4-7)
 - 360° Camera* (P. 4-11)
6. Push-button ignition switch (models with Remote Control Key system) (P. 5-10)
7. Meters and gauges (P. 2-2)
 - Vehicle information display (P. 2-12)
8. Bonnet release handle (P. 3-17)

9. Ignition switch (models without Remote Control Key system) (P. 5-8)
10. Steering wheel
 - Horn (P. 2-31)
 - Driver's supplemental front-impact air bag* (P. 1-29)
 - Power steering system (P. 5-42)
11. USB (Universal Serial Bus) connection port (P. 4-33)/iPod connection port (P. 4-41)
 - Auxiliary (AUX) input jack (P. 4-33)
12. Parking brake
 - Operation (P. 3-26)
 - Check (P. 8-9)
13. Power door lock switch (P. 3-4)
14. Hill descent control switch* (P. 5-31)
15. Differential lock mode switch* (P. 5-26)
16. Four-Wheel Drive (4WD) mode switch* (P. 5-20)
17. Heater and air conditioner control (P. 4-20)
18. Glove box (P. 2-34)
 - Fuse box (P. 8-19)

Ⓐ: 4WD models

Ⓑ: 2WD models

*: where fitted

** : See the separate Touchscreen Navigation Owner's Manual (where fitted).

METERS AND GAUGES

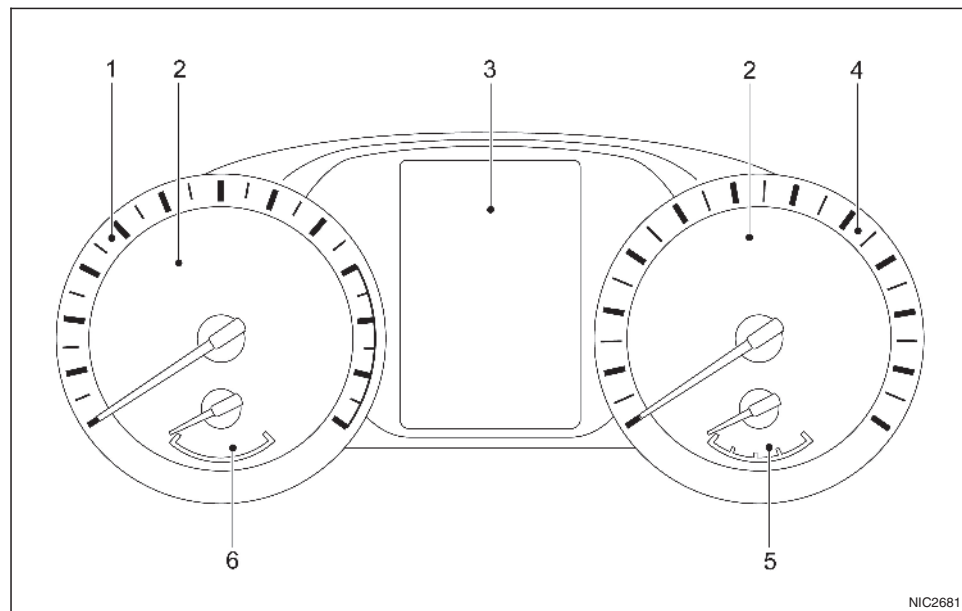

1. Tachometer (P. 2-3)
 2. Warning and indicator lights (P. 2-3)
 3. Vehicle information display (P. 2-12)
 - Four-Wheel Drive (4WD) mode indicator* (P. 5-24)
 - Oil control system* (P. 2-24)
 - Odometer/twin trip odometer (P. 2-3)
 - Trip computer (P. 2-17)
 4. Speedometer (P. 2-2)
 - Instrument brightness control (P. 2-4)
 - Automatic Transmission (AT) position indicator (AT model) (P. 2-24, P. 5-13)
 5. Fuel gauge (P. 2-2)
 6. Engine coolant temperature gauge (P. 2-3)
- *: where fitted

ENGINE COMPARTMENT

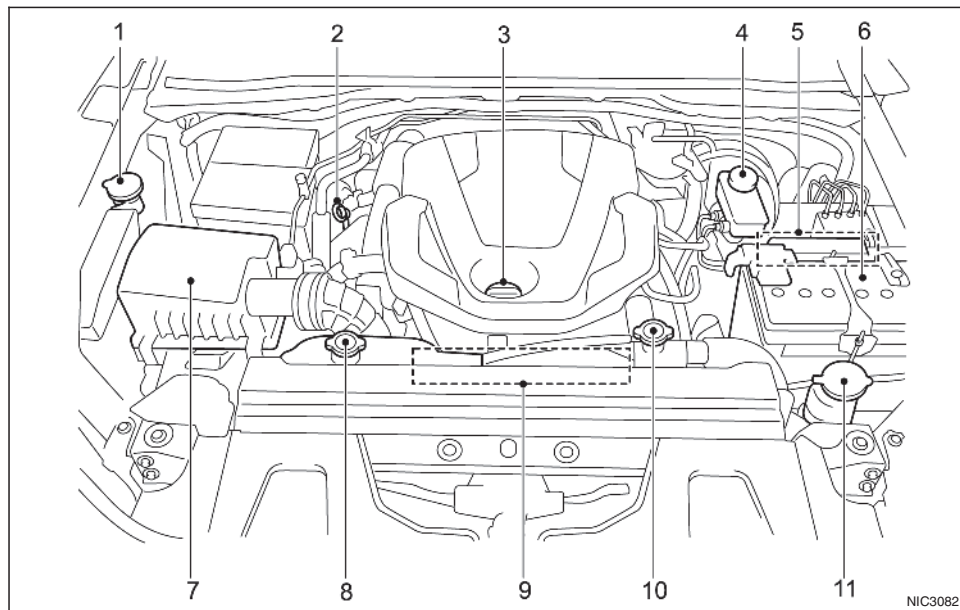

M9T 2.3DCI ENGINE

1. Window washer fluid reservoir (P. 8-11)
2. Engine oil dipstick (P. 8-7)
3. Engine oil filler cap (P. 8-7)
4. Brake and clutch*1,*2 fluid reservoir (P. 8-10)
5. Fuse/fusible link holder (P. 8-18)
6. Battery (P. 8-12)
 - Jump starting (P. 6-11)
7. Air cleaner (P. 8-15)
8. Engine coolant reservoir (P. 8-5)
9. Engine drive belt location (P. 8-8)
10. Radiator filler cap (P. 8-5)
 - Vehicle overheat (P. 6-13)

11. Power steering fluid reservoir (P. 8-8)

*1: For Manual Transmission (MT) model

*2: The layout illustrated is for the Left-Hand Drive (LHD) model. On the Right-Hand Drive (RHD) model, brake (and clutch) fluid reservoir is located on the opposite side.

NOTE

1 Safety — seats, seat belts and supplemental restraint system

Seats	1-2	Seat belt maintenance	1-14
Front seats	1-2	Child restraints	1-14
Rear seats (Double Cab model)	1-5	Precautions on child restraint usage	1-14
Jump seats (where fitted for King Cab models)	1-6	Universal child restraints for front seat and rear seats (for Europe)	1-15
Head restraints	1-6	ISOFIX and i-Size child restraint system (for second row seats)	1-20
Adjustable head restraint	1-6	Child restraint anchorage (where fitted)	1-21
Non-adjustable head restraint	1-7	Child restraint installation using ISOFIX	1-22
Remove	1-7	Child restraint installation using three-point type seat belt	1-24
Install	1-7	Supplemental Restraint System (SRS) (where fitted)	1-29
Adjust	1-8	Precautions on Supplemental Restraint System (SRS)	1-29
Seat belts	1-9	Supplemental air bag systems	1-35
Precautions on seat belt usage	1-9	Pre-tensioner seat belt system (where fitted)	1-38
Child safety	1-11	Repair and replacement procedure	1-38
Pregnant women	1-11		
Injured persons	1-11		
Centre mark on seat belts (where fitted)	1-11		
Three-point type seat belts	1-12		
Two-point type seat belts (where fitted)	1-13		

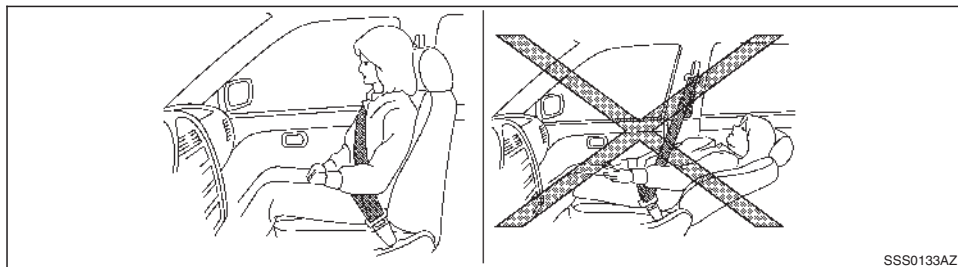

SSS0133AZ

WARNING

Do not drive and/or ride in the vehicle with the seatback reclined. This can be dangerous. The shoulder belt will not be properly against the body. In an accident, you and your passengers could be thrown into the shoulder belt and receive neck or other serious injuries. You and your passengers could also slide under the lap belt and receive serious injuries.

For the most effective protection while the vehicle is in motion, the seatback should be upright. Always sit well back and upright in the seat and adjust the seat properly. (See "Manual seat adjustment (where fitted)" later in this section.)

Do not leave children unattended inside the vehicle. They could unknowingly activate switches or controls, or make the vehicle move. Unattended children could become involved in serious accidents.

To help avoid risk of injury or death through unintended operation of the vehicle and/or its systems, do not leave children, people who require the assistance of others, or pets unattended in your vehicle. Additionally, the temperature inside a closed vehicle on a warm day can quickly become high enough to cause a significant risk of injury or death to people and pets.

CAUTION

When adjusting the seat positions, be sure not to contact any moving parts to avoid possible injuries and/or damages.

FRONT SEATS

WARNING

Do not adjust the driver's seat while driving so that full attention may be given to vehicle operation.

Manual seat adjustment (where fitted)

WARNING

After adjusting a seat, gently shake the seat to confirm that the seat is locked securely. If the seat is not locked securely, it may move suddenly and could cause the loss of control of the vehicle.

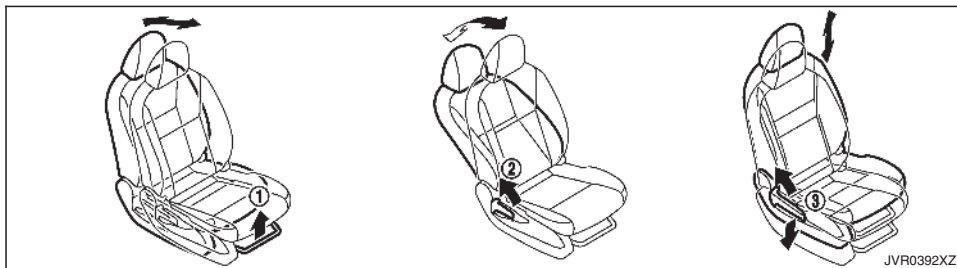

Forward and backward:

1. Pull the adjusting lever ① up.
2. Slide the seat to the desired position.
3. Release the adjusting lever to lock the seat in position.

Reclining:

CAUTION

When moving the seats forward or backward, or returning a rear-reclined seatback to its upright position, make sure you hold onto the seatback while operating. If the seatback is not held, the seat or seatback will move suddenly and could cause injury.

1. Pull the adjusting lever ② up.
2. Tilt the seatback to the desired position.
3. Release the adjusting lever to lock the seatback in position.

The reclining feature allows the adjustment of the seatback for occupants of different sizes to help obtain the proper seat belt fit. (See “Fastening seat belts” later in this section.)

The seatback may be reclined to allow occupants to rest when the vehicle is parked.

Seat lifter (where fitted):

Pull up or push down the adjusting lever ③ to adjust the seat height until the desired position is achieved.

Power seat adjustment (where fitted)



WARNING

Never leave children or adults who would normally require the support of others alone in the vehicle. Pets should not be left alone either. They could unknowingly activate switches or controls, or move the vehicle, and inadvertently become involved in a serious accident and injure themselves.

Operating tips:

The power seat motor has an auto-reset overload protection circuit. If the motor stops during the seat adjustment, wait 30 seconds, then re-activate the switch.

To avoid discharge of the battery, do not operate the power seats for a long period of time when the engine is not running.

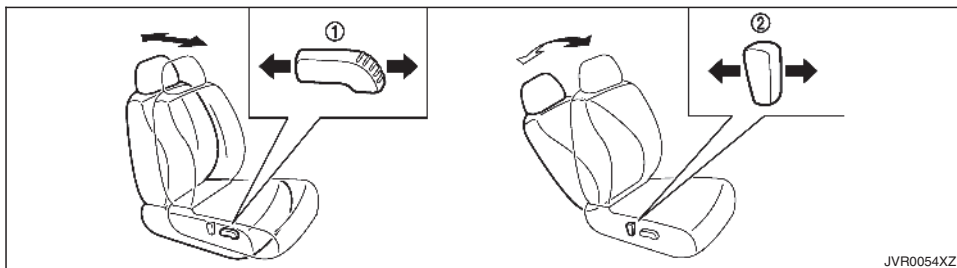

JVR0054XZ

Forward and backward:

Move the adjusting switch ① forward or backward to the desired position.

Reclining:

Move the adjusting switch ② forward or backward to the desired position.

The reclining feature allows the adjustment of the seatback for occupants of different sizes to help obtain the proper seat belt fit. (See "Fastening seat belts" later in this section.)

The seatback may be reclined to allow occupants to rest when the vehicle is parked.



WARNING

The seatback should not be reclined any more than needed for comfort. Seat belts are most effective when the passenger sits well back and straight up in the seat. If the seatback is reclined, the risk of sliding under the lap belt and being injured is increased.

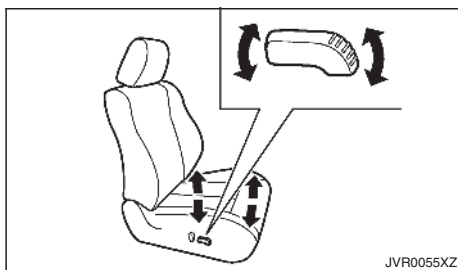

JVR0055XZ

Seat lifter:

1. Pull up or push down the adjusting switch as shown to adjust the seat height until the desired position is achieved.
2. Tilt up or down the adjusting switch as shown to adjust the front angle of the seat until the desired position is achieved.

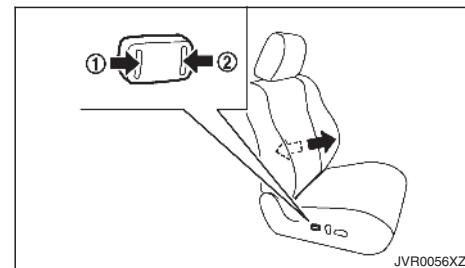

JVR0056XZ

Lumbar support:

The lumbar support feature provides lower back support to the driver.

Push each side of the adjusting switch ① and ② to adjust the seat lumbar area until the desired position is achieved.

Heated seats (where fitted)

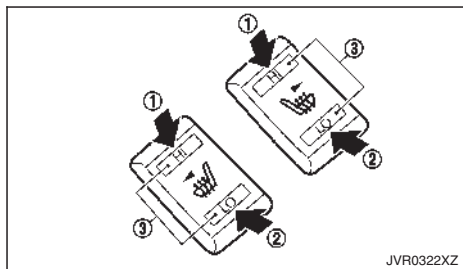

The front seats can be warmed by built-in heaters. The switches located on the centre console can be operated independently of each other.

1. Start the engine.
2. Select heat range.

For high heat, push the <HI> (High) side of the switch ①.

For low heat, push the <LO> (Low) side of the switch ②.

The indicator light ③ will illuminate when the heater is on.

3. To turn off the heater, return the switch to the level position. Make sure the indicator light turns off.

The heater is controlled by a thermostat, automatically turning the heater on and off. The indicator light will remain on as long as the switch is on.

When the vehicle's interior is warmed be sure to turn off the switch.

CAUTION

The battery could run down if the seat heater is operated while the engine is not running.

Do not use the seat heater for extended periods or when no one is using the seat.

Do not put anything on the seat which insulates heat, such as a blanket, cushion, seat cover, etc. Otherwise, the seat may become overheated.

Do not place anything hard or heavy on the seat or pierce it with a pin or similar object. This may result in damage to the seat heater.

Any liquid spilled on the heated seat should be removed immediately with a dry cloth.

When cleaning the seat, never use petrol, thinner, or any similar materials.

If any malfunctions are found or the heated seat does not operate, turn the switch off and have the system checked by an approved dealer or qualified workshop.

REAR SEATS (Double Cab model)

Folding

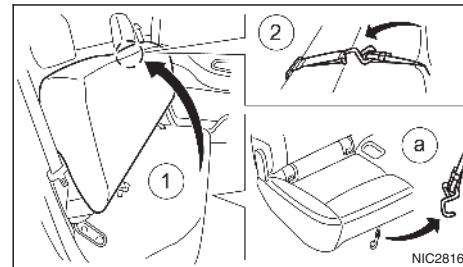

The jack and tools are stored in the tool storage compartment located under the rear seat cushion. To access the tool storage compartment, fold the rear seats in the following steps.

1. Remove the hook ①.
2. Lift up the seat cushion ②.
3. Secure the seat cushion with the strap ③.

To remove the jack and tools, see "Preparing tools" in the "6. In case of emergency" section.

Do not drive the vehicle with the rear seat folded.

When returning the rear seat to the original position, be certain the seat belts and the buckles are positioned properly. Secure the seat cushion using the hook ①.

HEAD RESTRAINTS



WARNING

Never allow anyone to ride on the rear seats when they are in the fold-up position. Use of this area by passengers without proper restraints could result in serious injury or death in an accident or sudden stop.

When folding or returning the rear seat, be careful not to squeeze your finger between the seat cushion and the body side.

JUMP SEATS (where fitted for King Cab models)

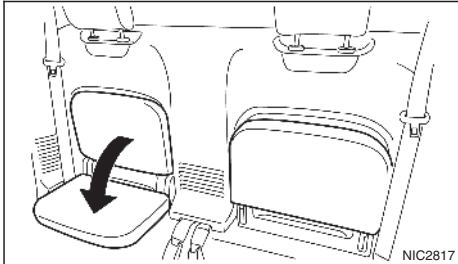

WARNING

Do not use the jump seats for child restraint installation.

When folding or returning the jump seat, be careful not to squeeze your finger between the seat cushion and the body side.

Jump seats are designed as temporary seats only and should only be used on occasional short distance travels.



WARNING

Head restraints supplement the other vehicle safety systems. They may provide additional protection against injury in certain rear end collisions. Adjustable head restraints must be adjusted properly, as specified in this section. Check the adjustment after someone else uses the seat. Do not attach anything to the head restraint stalks or remove the head restraint. Do not use the seat if the head restraint has been removed. If the head restraint was removed, reinstall and properly adjust the head restraint before an occupant uses the seating position. Failure to follow these instructions can reduce the effectiveness of the head restraint. This may increase the risk of serious injury or death in a collision.

Your vehicle is equipped with a head restraint that may be integrated, adjustable or non-adjustable.

Adjustable head restraints have multiple notches along the stalk to lock them in a desired adjustment position.

The non-adjustable head restraints have a single locking notch to secure them to the seat frame.

Proper Adjustment:

- For the adjustable type, align the head restraint so the centre of your ear is approximately level with the centre of the head restraint.
- If your ear position is still higher than the recommended alignment, place the head restraint at the highest position.

If the head restraint has been removed, ensure that it is reinstalled and locked in place before riding in that designated seating position.

ADJUSTABLE HEAD RESTRAINT

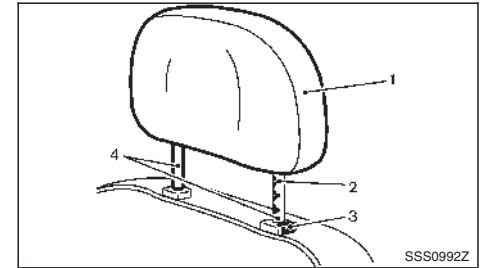

1. Removable head restraint
2. Multiple notches
3. Lock knob
4. Stalks

NON-ADJUSTABLE HEAD RESTRAINT

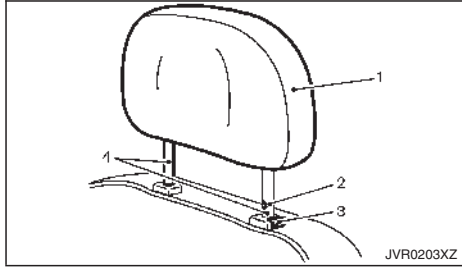

1. Removable head restraint
2. Single notch
3. Lock knob
4. Stalks

REMOVE

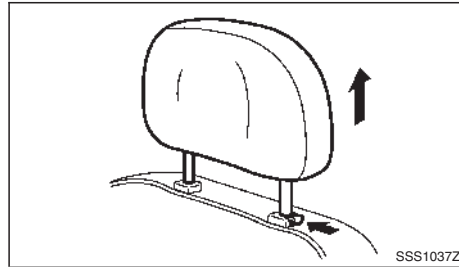

Use the following procedure to remove the head restraint.

1. Pull the head restraint up to the highest position.
2. Push and hold the lock knob.
3. Remove the head restraint from the seat.
4. Store the head restraint properly in a secure place so it is not loose in the vehicle.
5. Reinstall and properly adjust the head restraint before an occupant uses the seating position.

INSTALL

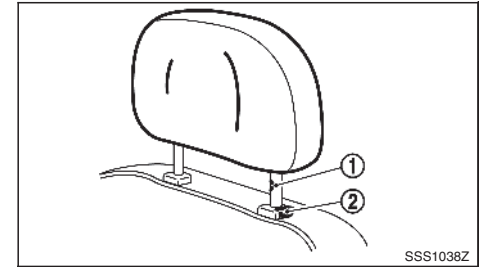

1. Align the head restraint stalks with the holes in the seat. Make sure that the head restraint is facing the correct direction. The stalk with the adjustment notch ① must be installed in the hole with the lock knob ②.
2. Push and hold the lock knob and push the head restraint down.
3. Properly adjust the head restraint before an occupant uses the seating position.

ADJUST

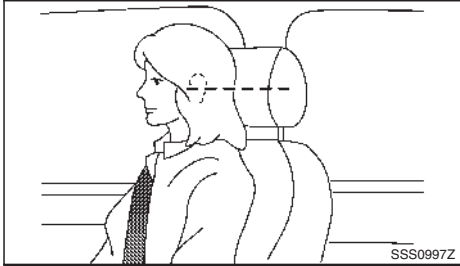

For adjustable head restraint

Adjust the head restraint so the centre is level with the centre of your ears. If your ear position is still higher than the recommended alignment, place the head restraint at the highest position.

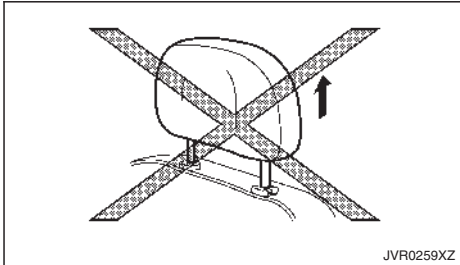

For non-adjustable head restraint

Make sure the head restraint is positioned from the stored position or any non-latch position so the lock knob is engaged in the notch before riding in that designated seating position.

Raise

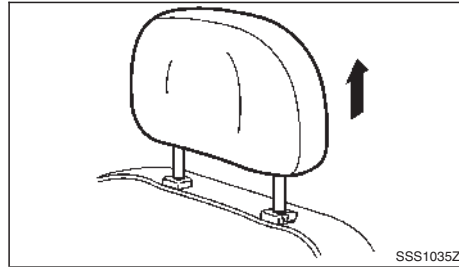

Type A

To raise the head restraint, pull it up.

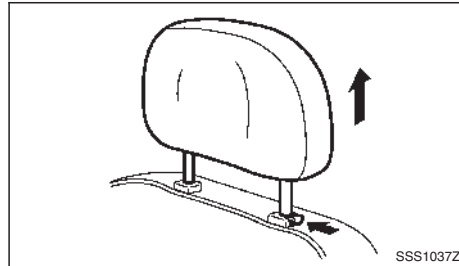

Type B

To raise the head restraint, push and hold the lock knob. Then, pull it up.

Make sure the head restraint is positioned from the stored position or any non-latch position so the lock knob is engaged in the notch before riding in that designated seating position.

Lower

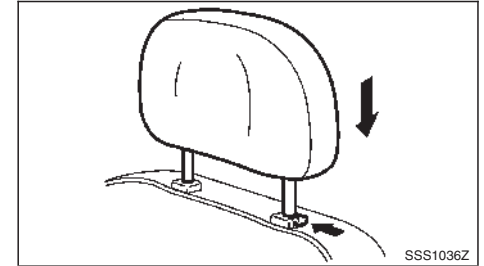

To lower, push and hold the lock knob and push the head restraint down.

Make sure the head restraint is positioned so the lock knob is engaged in the notch before riding in that designated seating position.

SEAT BELTS

PRECAUTIONS ON SEAT BELT USAGE

If you are wearing the seat belt properly adjusted and sitting upright and well back in the seat, chances of being injured or killed in an accident and/or the severity of injury may be greatly reduced. RENAULT strongly encourages you and all of your passengers to buckle up every time you drive, even if your seating position includes the supplemental air bag systems.

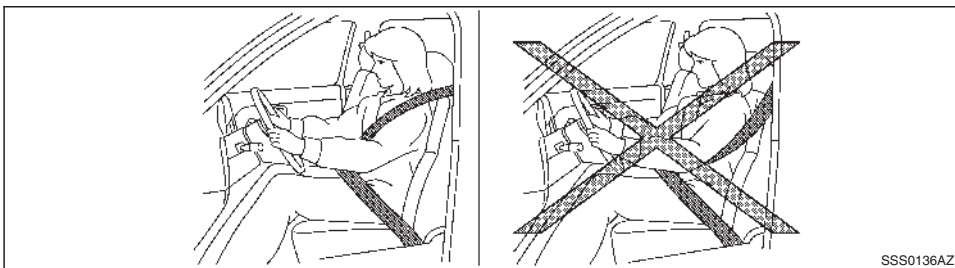
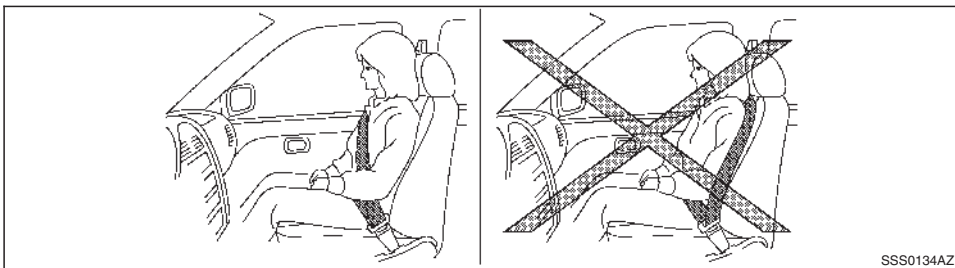

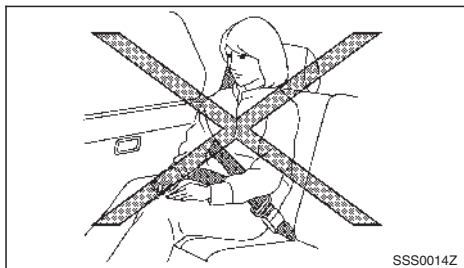

Position the lap belt as low and snug as possible around the hips, not the waist. A lap belt worn too high could increase the risk of internal injuries in an accident.

Do not allow more than one person to use the same seat belt. Each belt assembly must only be used by one occupant; it is dangerous to put a belt around a child being carried on the occupant's lap.

Never carry more people in the vehicle than there are seat belts.

Never wear seat belts inside out. Belts should not be worn with straps twisted. Doing so may reduce their effectiveness.

Seat belts should be adjusted as firmly as possible, consistent with comfort, to provide the protection for which they have been designed. A slack belt will greatly reduce the protection afforded to the wearer.

Every person who drives or rides in this vehicle should use a seat belt at all times. Children should be in the rear seats and in an appropriate restraint.

Do not put the belt behind your back or under your arm. Always route the shoulder belt over your shoulder and across your chest. The belt should be away from your face and neck, but not falling off your shoulder. Serious injury may occur if a seat belt is not worn properly.

No modifications or additions should be made by the user which will either prevent the seat belt adjusting devices from operating to remove slack, or prevent the seat belt assembly from being adjusted to remove slack.

Care should be taken to avoid contamination of the webbing with polishes, oils and chemicals, and particularly battery acid. Cleaning may safely be carried out using mild soap and water. The belt should be replaced if webbing becomes frayed, contaminated or damaged.

It is essential to replace the entire assembly after it has been worn in a severe impact even if damage to the assembly is not obvious.

All seat belt assemblies including retractors and attaching hardware should be inspected after any collision by an approved dealer or qualified workshop. RENAULT recommends that all seat belt assemblies in use during a collision be replaced unless the collision was minor and the belts show no damage and continue to operate properly. Seat belt assemblies not in use during a collision should also be inspected and, when necessary, replaced if either damage or improper operation is noted.

Once the pre-tensioner seat belt (where fitted) has activated, it cannot be reused. It must be replaced together with the retractor. Contact an approved dealer or qualified workshop.

Removal and installation of the pre-tensioner seat belt system (where fitted) components should be done by an approved dealer or qualified workshop.

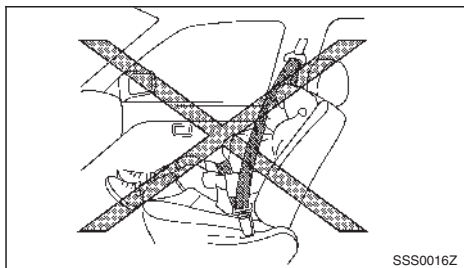

 **WARNING**

Seat belts are designed to bear upon the bony structure of the body, and should be worn low across the front of the pelvis or the pelvis, chest and shoulders, as applicable; wearing the lap section of the belt across the abdominal area must be avoided. Serious injury may occur if a seat belt is not worn properly.

CHILD SAFETY



WARNING

Infants and children need special protection. The vehicle's seat belts may not fit them properly. The shoulder belt may come too close to the face or neck. The lap belt may not fit over their small hipbones. In an accident, an improperly fitted seat belt could cause serious or fatal injury.

Always use an appropriate child restraint system.

Children need adults to help protect them. They need to be properly restrained. The proper restraint depends on the child's size.

Infants and small children

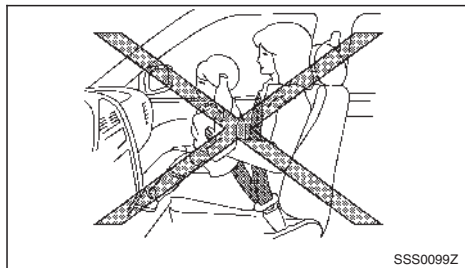

RENAULT recommends that infants and small children be seated in a child restraint system. You should choose a child restraint system that fits your vehicle and the child, and always follow the manufacturer's instructions for installation and use.

Large children



WARNING

Never allow children to stand or kneel on any seats.

Never allow children in the luggage areas while the vehicle is moving. A child could be seriously injured in an accident or sudden stop.

Children who are too large for a child restraint system should be seated and restrained by the seat belts that are provided.

If the child's seating position has a shoulder belt that fits close to the face or neck, the use of a booster seat (commercially available) may help overcome this. The booster seat should raise the child so that the shoulder belt is properly positioned across the top, middle portion of the shoulder and the lap belt is low on the hips. The booster seat should also fit the vehicle seat. Once the child has grown so that the shoulder belt is no longer on or near the face or neck of the child, use the shoulder belt without the booster seat. In addition, there are many types of child restraint systems available for larger children that should be used for maximum protection.

PREGNANT WOMEN

RENAULT recommends that pregnant women use seat belts. The seat belt should be worn snug, and always position the lap belt as low as possible around the hips, not the waist. Place the shoulder belt over your shoulder and across your chest. Never

run the lap/shoulder belt over your abdominal area. Contact your doctor for specific recommendations.

INJURED PERSONS

RENAULT recommends that injured persons use seat belts. Contact your doctor for specific recommendations.

CENTRE MARK ON SEAT BELTS (where fitted)

Selecting correct set of seat belts

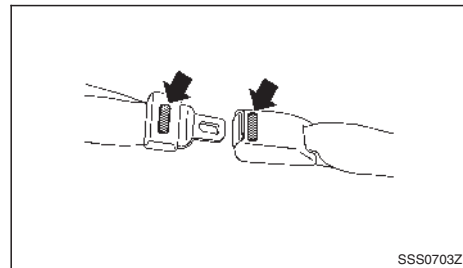

The centre seat belt buckle (and/or tongue, where fitted) is identified by the <CENTER> mark. The centre seat belt tongue can be fastened only into the centre seat belt buckle.

THREE-POINT TYPE SEAT BELTS

Fastening seat belts



WARNING

The seatback should not be in a reclined position any more than needed for comfort. Seat belts are most effective when the passenger sits well back and straight up in the seat.

1. Adjust the seat. (See "Manual seat adjustment (where fitted)" earlier in this section.)
2. Slowly pull the seat belt out of the retractor and insert the tongue into the buckle until you hear and feel the latch engage.

The retractor is designed to lock during a sudden stop or on impact. A slow pulling motion permits the seat belt to move, and allows you some freedom of movement in the seat.

If the seat belt cannot be pulled from its fully retracted position, firmly pull the belt and release it. Then smoothly pull the belt out of the retractor.

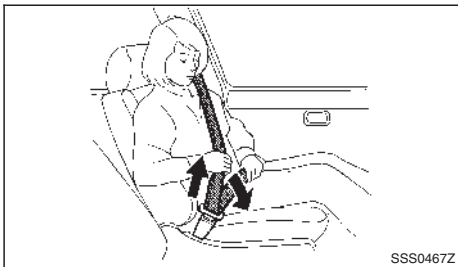

3. Position the lap belt portion low and snug on the hips as shown.
4. Pull the shoulder belt portion toward the retractor to take up extra slack. Be sure the shoulder belt is routed over your shoulder and is snug across your chest.

Shoulder belt height adjustment (for front seats)

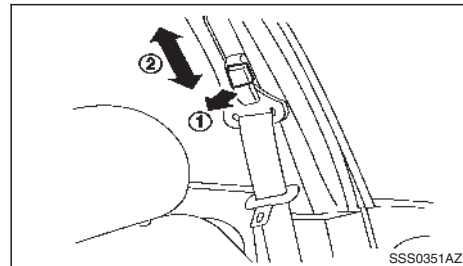

WARNING

The shoulder belt anchor height should be adjusted to the position best for you. Failure to do so may reduce the effectiveness of the entire restraint system and increase the chance or severity of injury in an accident.

The shoulder belt should rest on the middle of the shoulder. It must not rest against the neck.

Be sure that the seat belt is not twisted in any way.

Be sure that the shoulder belt anchor is secured by trying to move the shoulder belt anchor up and down after adjustment.

To adjust, pull on the release button ① and move the shoulder belt anchor to the proper position ②, so that the belt passes over the centre of the shoulder. The belt should be away from your face and neck, but not falling off your shoulder. Release the button to lock the shoulder belt anchor into position.

Unfastening seat belts

Push the button on the buckle. The seat belt automatically retracts.

Checking seat belt operation

Seat belt retractors are designed to lock seat belt movement:

When the seat belt is pulled quickly from the retractor.

When the vehicle slows down rapidly.

To increase your confidence in the seat belts, check the operation by grasping the shoulder belt and pulling forward quickly. The retractor should lock and restrict further belt movement. If the retractor does not lock during this check, contact an approved dealer or qualified workshop immediately.

TWO-POINT TYPE SEAT BELTS (where fitted)

Fastening seat belts



WARNING

Every person who drives or rides in this vehicle should use a seat belt at all times.

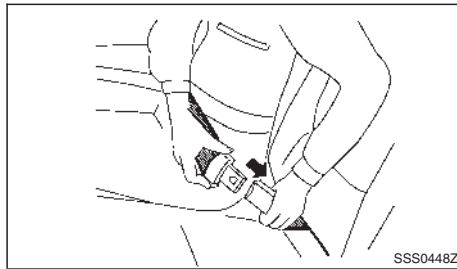

1. Insert the tongue into the buckle with the <CENTER> mark (where fitted) until you hear and feel the latch engage.

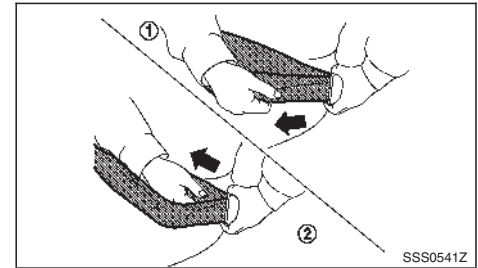

2. Adjust the seat belt length. To shorten, hold the tongue and pull the upper belt as illustrated ①. To lengthen, hold the tongue and pull the under belt as illustrated ②.

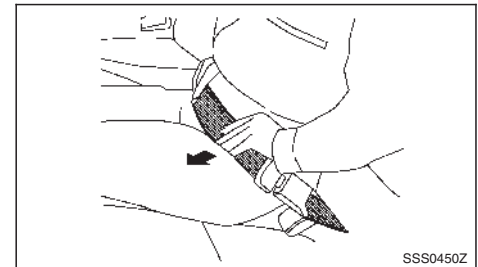

3. Position the lap belt portion low and snug on the hips as shown.

Unfastening seat belts

Push the button on the buckle.

CHILD RESTRAINTS

SEAT BELT MAINTENANCE

Periodically check that the seat belt and all the metal components, such as buckles, tongues, retractors, flexible wires and anchors, work properly. If loose parts, deterioration, cuts or other damage on the seat belt webbing is found, the entire seat belt assembly should be replaced.

If dirt builds up in the shoulder belt guide of the seat belt anchors, the seat belts may retract slowly. Wipe the shoulder belt guide with a clean, dry cloth.

To clean the seat belt webbing, apply a mild soap solution or any solution recommended for cleaning upholstery or carpet. Then wipe with a cloth and allow the seat belts to dry in the shade. Do not allow the seat belts to retract until they are completely dry.

PRECAUTIONS ON CHILD RESTRAINT USAGE

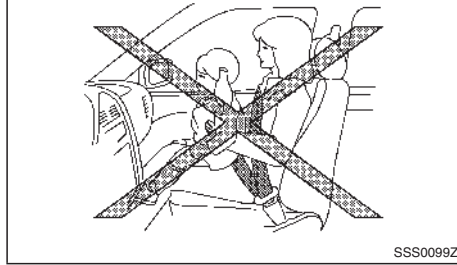

WARNING

Infants and small children should never be carried on your lap. It is not possible for even the strongest adult to resist the forces of a severe accident. The child could be crushed between the adult and parts of the vehicle. Also, it is dangerous to put a seat belt around a child being carried on the occupant's lap.

Infants and children need special protection. The vehicle's seat belts may not fit them properly. The shoulder belt may come too close to the face or neck. The lap belt may not fit over their small hip bones. In an accident, an improperly fitting seat belt could cause serious or fatal injury.

Infants and small children should always be placed in an appropriate child restraint system while riding in the vehicle. Failure to use a child restraint system can result in serious injury or death.

Child restraint systems specially designed for infants and small children are available from several manufacturers. When selecting any child restraint systems, place your child in the child restraint system and check the various adjustments to be sure that the child restraint system is compatible with your child. Always follow the manufacturer's instructions for installation and use.

RENAULT recommends that the child restraint system be installed in the rear seat (Double Cab model). According to accident statistics, children are safer when properly restrained in the rear seat rather than in the front seat.

Follow all of the child restraint system manufacturer's instructions for installation and use. When purchasing a child restraint system, be sure to select one which will fit your child and vehicle. It may not be possible to properly install some types of child restraint systems in your vehicle.

The direction of the child restraint, either front-facing or rear-facing, depends on the type of the child restraint and the size of the child. Refer to the child restraint manufacturer's instructions for details.

For a front-facing child restraint system, check to make sure the shoulder belt does not fit close to child's face or neck. If you must install a front-facing child restraint system in the front seat, see "Installation on front passenger's seat" later in this section.

Never install a rear-facing child restraint system on the front passenger's seat when the front passenger's air bag is active. Supplemental front-impact air bags inflate with great force. A rear-facing child restraint system could be struck by the supplemental front-impact air bags in an accident and could seriously injure or kill your child.

Do not install a child restraint in the jump seats (where fitted for King Cab model). These seats are not suitable for child restraint installation.

Adjustable seatbacks should be positioned to fit a child restraint system, but as upright as possible. see "Installation on rear outboard seats" later in this section and "Child restraint installation using three-point type seat belt" later in this section.

If the seat belt in the position where a child restraint system is installed requires a locking clip and if it is not used, injuries could result from a child restraint system tipping over during normal vehicle braking or cornering.

After attaching a child restraint system, test it before you place the child in it. Tilt it from side to side. Try to tug it forward and check if it is held securely in place. The child restraint system should not move more than 25 mm (1 in).

If the restraint is not secure, tighten the belt as necessary, or install the restraint in another seat and test it again.

Check the child restraint system in your vehicle to be sure that it is compatible with the vehicle's seat belt system.

If a child restraint system is not anchored properly, the risk of a child being injured in a collision or a sudden stop greatly increases.

Improper use of a child restraint system can increase the risk or severity of injury for both the child and other occupants in the vehicle.

Always use an appropriate child restraint system. An improperly installed child restraint system could lead to serious injury or death in an accident.

When the child restraint system is not in use, keep it secured with the ISOFIX and i-Size child restraint system or a seat belt to prevent it from being thrown around in case of a sudden stop or accident.

RENAULT recommends that infants and small children be seated in a child restraint system. You should choose a child restraint system that fits your vehicle and always follow the manufacturer's instructions for installation and use. In addition, there are many types of child restraint systems available for larger children that should be used for maximum protection.

CAUTION

Remember that a child restraint system left in a closed vehicle can become very hot. Check the seating surface and buckles before placing your child in a child restraint system.

UNIVERSAL CHILD RESTRAINTS FOR FRONT SEAT AND REAR SEATS (for Europe)

NOTE

Child restraints approved to UN Regulation No. 44 or No. 129 are clearly marked with the categories such as Universal, Semi-universal or ISOFIX.

When selecting any child restraint, keep the following points in mind:

Choose a child restraint that complies with the latest European safety standard, UN Regulation No. 44 or No. 129.

Place your child in the child restraint and check the various adjustments to be sure the child restraint is compatible with your child. Always follow all of the recommended procedures.

Check the child restraint in your vehicle to be sure it is compatible with vehicle's retention system.

Refer to the tables later in this section for a list of the recommended fitment positions of child restraints for your vehicle.

Mass group of child restraint

Mass group	Child's weight
Group 0	up to 10 kg
Group 0+	up to 13 kg
Group I	9 to 18 kg
Group II	15 to 25 kg
Group III	22 to 36 kg

Examples of child seat types:

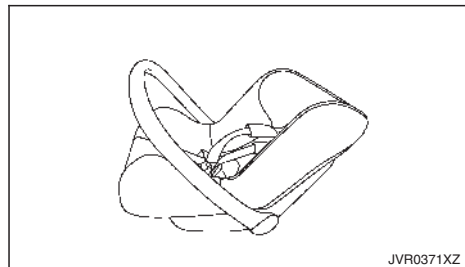

Child safety seat categories 0 and 0+

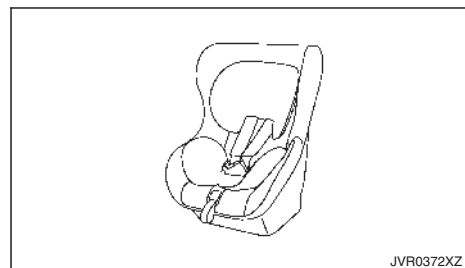

Child safety seat categories 0+ and I

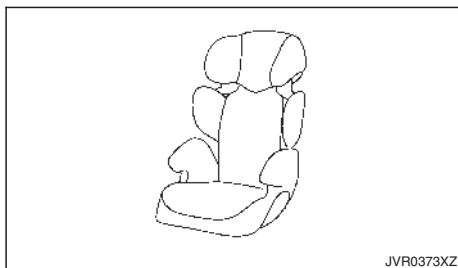

Child safety seat categories II and III

Child restraint installation using the vehicle's seat belt

The following restriction is applied when using child restraints varying by infants weight and installation position.

Mass group		Seating position			
		Front passenger seat (Air bag ON)	Front passenger seat (Air bag OFF)	Second row outer seat	Second row centre seat *4
O	<10 kg	X	L*3	U/L*2	U*2
O+	<13 kg	X	L*3	U/L*2	U*2
I	9 - 18 kg	X	L*1,*3	U/L*1,*2	U*1,*2
II	15 - 25 kg	X	L*1,*3	U/L*1,*2	U*1,*2
III	22 - 36 kg	X	L*1,*3	U/L*1,*2	U*1,*2

U: Suitable for "Universal" category child restraint systems, forward and rearward facing, approved for use in this mass group.

UF: Suitable for "Universal" category child restraint systems, forward facing only, approved for use in this mass group.

L: Suitable for particular child restraint systems of the "Specific for the vehicle", "Restricted", or "Semi-universal" categories, approved for use in this mass group.

X: Seat position not suitable for children in this mass group.

*1: Move the head restraint to the uppermost position or, if necessary, remove it in case of any interference with the child restraint. Do not remove head restraint when using a booster cushion only.

*2: Adjust the front seat(s) slide position sufficiently forward and/or the seat height adjustment (if available) to the uppermost position to ensure there is no contact between child seat and back of front seat.

*3: Move the front passenger seat as far rearward as possible.

*4: Suitable only for "Universal" category of child restraints. Do not install child restraints with support leg.

Child restraint installation using ISOFIX

The following restriction is applied when using child restraints varying by infant's weight and installation position.

Mass group			Seating position			
			Front passenger seat (Air bag ON)	Front passenger seat (Air bag OFF)	Second row outer seat	Second row centre seat
Carry-cot	F	ISO/L1	X	X	X	X
	G	ISO/L2	X	X	X	X
O+ (<10 kg)	E	ISO/R1	X	X	IL*2	X
O+ (<13 kg)	E	ISO/R1	X	X	IL*2	X
	D	ISO/R2	X	X	IL*2	X
	C	ISO/R3	X	X	IL*2	X
I (9 - 18 kg)	D	ISO/R2	X	X	IL*2	X
	C	ISO/R3	X	X	IL*2	X
	B	ISO/F2	X	X	IUF/IL*1,*2	X
	B1	ISO/F2X	X	X	IUF/IL*1,*2	X
	A	ISO/F3	X	X	IUF/IL*1,*2	X
II (15 - 25 kg)	—	—	X	X	IL*1,*2	X
III (22 - 36 kg)	—	—	X	X	IL*1,*2	X

X: Not suitable for installation of ISOFIX child restraint systems (CRS) in these seating positions.

IUF: Suitable for ISOFIX forward facing CRS of universal category approved for use in this mass group.

IL: Suitable for particular ISOFIX child restraint systems of the "Specific for the vehicle", "Restricted", or "Semi-universal" categories, approved for this type of vehicle.

*1: Move the head restraint to the uppermost position or, if necessary, remove it in case of any interference with the child restraint. Do not remove head restraint when using a booster cushion only.

*2: Adjust the front seat(s) slide position sufficiently forward and/or the seat height adjustment (if available) to the uppermost position to ensure there is no contact between child restraint and back of front seat.

Child restraint installation using i-Size ISOFIX

The following restriction is applied when using child restraints varying by infant's weight and installation position.

	Seating position			
	Front passenger seat (Air bag ON)	Front passenger seat (Air bag OFF)	Second row outer seat	Second row centre seat
i-Size child restraint systems	X	X	i-U *1,*2	X

X: Seating position not suitable for installation of i-Size "universal" child restraint systems.

i-U: Suitable for i-Size "universal" child restraint systems, forward and rearward facing.

*1: Move the head restraint to the uppermost position or, if necessary, remove it in case of any interference with the child restraint. Do not remove head restraint when using a booster cushion only.

*2: Adjust the front seat(s) slide position sufficiently forward and/or the seat height adjustment (if available) to the uppermost position to ensure there is no contact between child restraint and back of front seat.

ISOFIX AND I-SIZE CHILD RESTRAINT SYSTEM (for second row seats)

Your vehicle is equipped with special anchor points that are used with ISOFIX and i-Size child restraint systems.

ISOFIX LOWER ANCHOR POINT LOCATIONS (Type A) (where fitted)

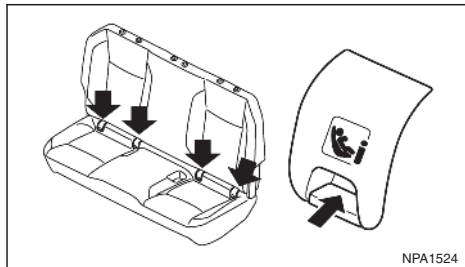

i-Size ISOFIX anchor point locations (Type A)

The ISOFIX anchor points are provided to install ISOFIX and i-Size child restraints in the second row outboard seating positions only. **Do not attempt to install a child restraint in the centre seating position using the ISOFIX anchors.**

The ISOFIX anchors are located at the rear of the seat cushion near the seatback. The ISOFIX anchor points are located under the covers, labelled as shown,

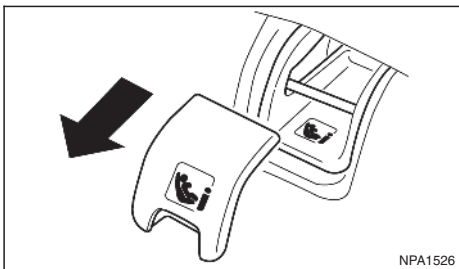

i-Size ISOFIX cover removal

To access an ISOFIX anchor point insert your finger into the cover and pull the cover off.

CAUTION

Store the loose ISOFIX covers to avoid losing and damaging them. For example, in the console box (see "Storage" in the "2. Instruments and controls" section).

ISOFIX LOWER ANCHOR POINT LOCATIONS (Type B) (where fitted)

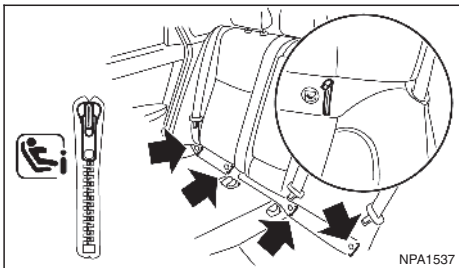

i-Size ISOFIX anchor point locations (Type B)

The ISOFIX anchor points are provided to install ISOFIX and i-Size child restraints in the second row outboard seating positions only. **Do not attempt to install a child restraint in the centre seating position using the ISOFIX anchors.**

The ISOFIX anchors are located at the rear of the seat cushion near the seatback. The i-Size symbols adjacent to the zips clearly identify the locations of the ISOFIX anchors.

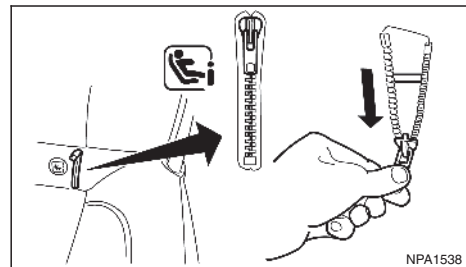

i-Size ISOFIX cover unzipped

To access an ISOFIX anchor point unzip the cover.

CAUTION

Always close the zips when not in use to avoid objects falling into the ISOFIX cavity.

ISOFIX child restraint anchor attachments

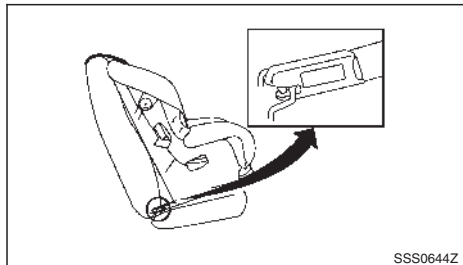

Anchor attachment

ISOFIX and i-Size child restraints include two rigid attachments that can be connected to two anchors located in the seat. With this system, you do not have to use a vehicle seat belt to secure the child restraint. Check your child restraint for a label stating that it is compatible with the ISOFIX or i-Size child restraints. This information may also be in the instructions provided by the child restraint manufacturer.

ISOFIX and i-Size child restraints generally require the use of a top tether strap or other anti-rotation devices such as support legs. When installing ISOFIX or i-Size child restraints, carefully read and follow the instructions in this manual and those supplied with the child restraints. (See "Child restraint anchorage (where fitted)" later in this section.)

CHILD RESTRAINT ANCHORAGE (where fitted)

Your vehicle is designed to accommodate a child restraint system on the rear seat. When installing a child restraint system, carefully read and follow the instructions in this manual and those supplied with the child restraint system.



WARNING

Child restraint anchorages are designed to withstand only those loads imposed by correctly fitted child restraints. Under no circumstances are they to be used for adult seat belts, harnesses or for attaching other items or equipment to the vehicle. Doing so could damage the child restraint anchorages. The child restraint will not be properly installed using the damaged anchorage, and a child could be seriously injured or killed in a collision.

ISOFIX Top Tether anchor location

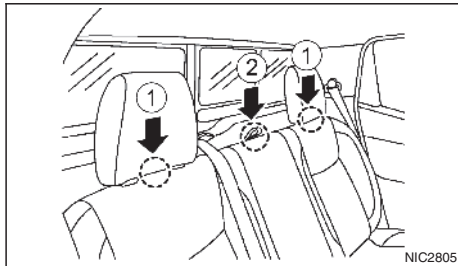

The anchor point is a strap loop located on the top of the second row centre seatback ②. There are two similar straps at the back of the 2nd row outer seats that are intended only as guide loops ①.

If the child restraint manufacturer recommends that the top tether strap be attached, attach and tighten the top tether strap to the top tether anchor (loop). Refer to the child restraint instructions and the following steps.

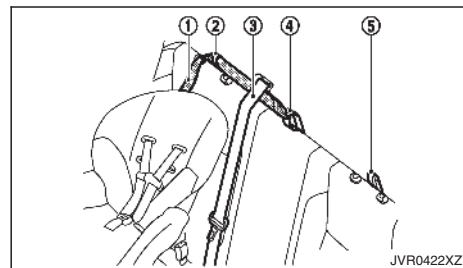

On the rear right outboard seating position

1. On the rear right outboard seating position:

- 1) Remove the head restraint of the rear right outboard seat.
- 2) Route the top tether strap ① through the right top tether guide (loop) ② and under the centre shoulder belt ③.
- 3) Attach the top tether strap ① to the top tether anchor (loop) ④ at the rear centre seating position.

2. On the rear left outboard seating position:

- 1) Remove the head restraint of the rear left outboard seat.
- 2) Route the top tether strap ① through the left top tether guide (loop) ⑤.
- 3) Attach the top tether strap ① to the top tether anchor (loop) ④ at the rear centre seating position.

3. On the rear left and right seat simultaneous use:

- 1) Follow steps 1 to 3 for each individual seat fitment but do not tighten the straps until both seats are anchored.
- 2) Then tighten each seat in turn taking care to ensure equal tension.

Tighten the top tether according to the child restraint manufacturer's instructions.

CAUTION

After installing the required child restraint system please ensure all portions of anchor straps are securely tensioned.

When the top tether strap is properly tightened, the top tether anchor (loop) may bend. This is normal and will not damage the vehicle.

CHILD RESTRAINT INSTALLATION USING ISOFIX



WARNING

Attach ISOFIX and i-Size child restraints only at the specified locations. For the ISOFIX lower anchor locations, see "ISOFIX lower anchor point locations (Type A) (where fitted)" earlier in this section. If a child restraint is not secured properly, your child could be seriously injured or killed in an accident.

Do not install child restraints that require the use of a top tether strap to seating positions that do not have a top tether anchor.

Do not secure a child restraint in the centre rear seating position using the ISOFIX lower anchors. The child restraint will not be secured properly.

Inspect the lower anchors by inserting your fingers into the lower anchor area and feeling to make sure there are no obstructions over the ISOFIX anchors, such as seat belt webbing or seat cushion material. The child restraint will not be secured properly if the ISOFIX anchors are obstructed.

Child restraint anchorages are designed to withstand only those loads imposed by correctly fitted child restraints. Under no circumstance are they to be used for adult seat belts, harnesses or for attaching other items or equipment to the vehicle. Doing so could damage the child restraint anchorages. The child restraint will not be properly installed using

the damaged anchorage, and a child could be seriously injured or killed in a collision.

Installation on rear outboard seats

Front-facing child restraints:

Be sure to follow the child restraint manufacturer's instructions for the proper use of your child restraint. Follow these steps to install a front-facing child restraint on the second row outboard seats using ISOFIX:

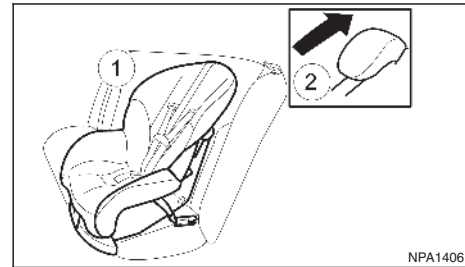

Steps 1, and 2

1. Position the child restraint on the seat ①.
2. Remove the head restraint ② to obtain the correct child restraint fit.

Once removed, store the head restraint in a secure place.

Be sure to reinstall the head restraint whenever the child restraint is removed (see "Head restraints" earlier in this section).

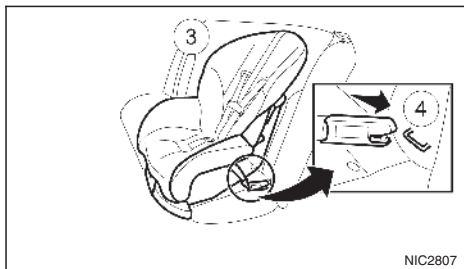

Steps 3, and 4

3. Check that the back of the child restraint is placed firmly against the vehicle seatback ③.
4. Secure the child restraint anchor attachments to the ISOFIX lower anchors ④.

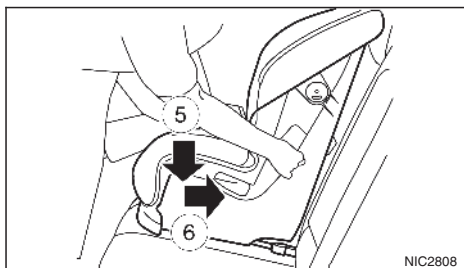

Step 5

5. Shorten the rigid attachment to have the child restraint firmly tightened; press downward ⑤ and rearward ⑥ firmly in the centre of the child

restraint with your knee to compress the vehicle seat cushion and seatback. Adjustable seatbacks should be positioned to ensure full contact between child restraint and seatback.

6. If the child restraint is equipped with a top tether strap, route the top tether strap and secure the tether strap to the tether anchor point. (See "Child restraint anchorage (where fitted)" earlier in this section.)

If the child restraint is equipped with other anti-rotation devices such as support legs, use them instead of (or together with) the top tether strap following the child restraint manufacturer's instructions.

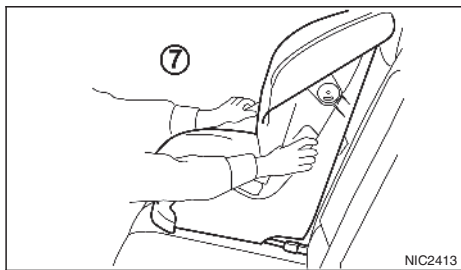

Step 7

7. Test the child restraint before you place the child in it ⑦. Push the child restraint from side to side and tug it forward to make sure that it is held securely in place.
8. Check to make sure that the child restraint is properly secured prior to each use. If the child restraint is loose, repeat steps 1 through 7.

Rear-facing child restraints:

Be sure to follow the child restraint manufacturer's instructions for the proper use of your child restraint. Follow these steps to install a rear-facing child restraint on the second row outboard seats using ISOFIX:

1. Remove the head restraint on the seat.

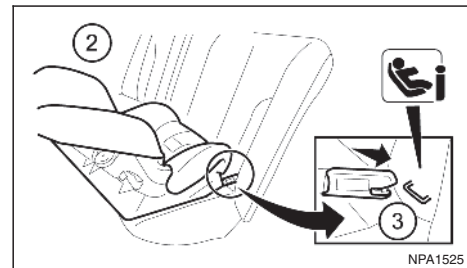

Step 2, and 3

2. Position the child restraint on the seat ②.
3. Secure the child restraint anchor attachments to the ISOFIX lower anchors ③.

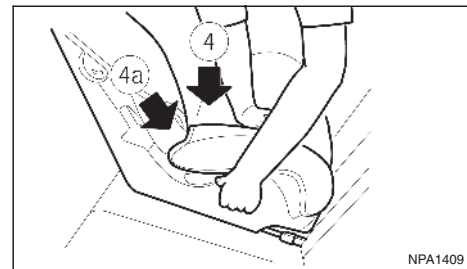

Step 4

- Shorten the rigid attachment to have the child restraint firmly tightened. To compress the vehicle seat cushion and seatback, firmly press downward ④ and rearward ⑤ in the centre of the child restraint with your hand.

If there is any contact between the child restraint and the front seat, slide the front seat forward until contact no longer occurs.

If the child restraint is equipped with other anti-rotation devices such as support legs, use them following the child restraint manufacturer's instructions.

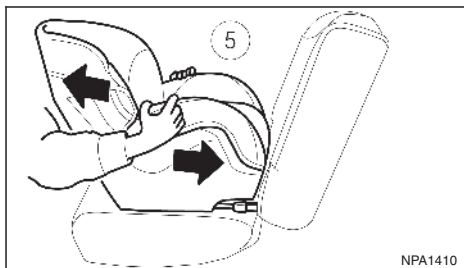

Step 5

NPA1410

- Test the child restraint before you place the child in it ⑤. Push the child restraint from side to side and tug it forward to make sure that it is held securely in place.
- Check to make sure that the child restraint is properly secured prior to each use. If the child restraint is loose, repeat steps 1 through 5.

CHILD RESTRAINT INSTALLATION USING THREE-POINT TYPE SEAT BELT

Installation on rear seats (Double Cab models)

Front-facing child restraint:

Be sure to follow the manufacturer's instructions for the proper use of your child restraint. Follow these steps to install a front-facing child restraint on the rear seats using three-point type seat belt without automatic locking mode:

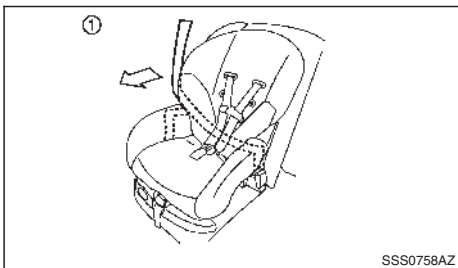

Front-facing: Step 1

SSS0758AZ

- Position the child restraint on the seat ①. If any contact occurs between the child restraint and the front seat, slide the front seat forward until contact no longer occurs.

Remove the head restraint to obtain the correct child restraint fit.

Once removed, store the head restraint in a secure location.

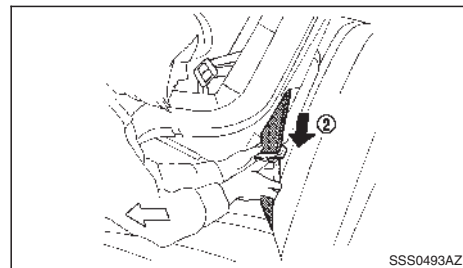

Front-facing: Step 2

SSS0493AZ

- Route the seat belt tongue through the child restraint and insert it into the buckle ② until you hear and feel the latch engage.
- To prevent slack in the seat belt webbing, it is necessary to secure the seat belt in place with locking devices attached to the child restraint.

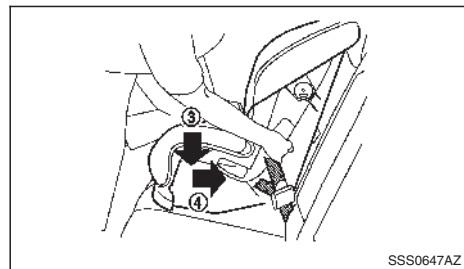

Front-facing: Step 4

SSS0647AZ

- Remove any additional slack from the seat belt; press downward ③ and rearward ④ firmly in the centre of the child restraint with your knee to compress the vehicle seat cushion and seatback while pulling up on the seat belt.

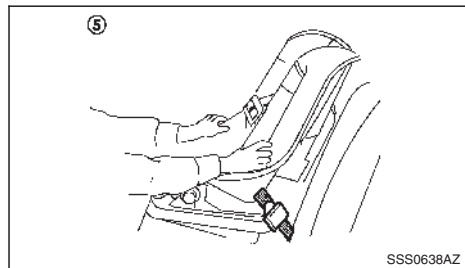

Front-facing: Step 5

- Test the child restraint before you place the child in it ⑤. Push the child restraint from side to side and tug it forward to make sure that it is held securely in place.
- Check to make sure that the child restraint is properly secured prior to each use. If the child restraint is loose, repeat steps 3 through 5.

Rear-facing child restraint:

Be sure to follow the manufacturer's instructions for the proper use of your child restraint. Follow these steps to install a rear-facing child restraint on the rear seats using three-point type seat belt without automatic locking mode:

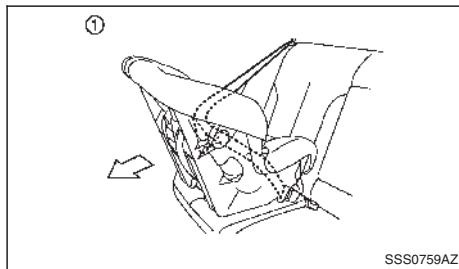

Rear-facing: Step 1

- Position the child restraint on the seat ①.

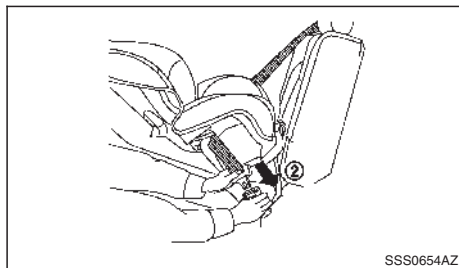

Rear-facing: Step 2

- Route the seat belt tongue through the child restraint and insert it into the buckle ② until you hear and feel the latch engage.

- To prevent slack in the seat belt webbing, it is necessary to secure the seat belt in place with locking devices attached to the child restraint.

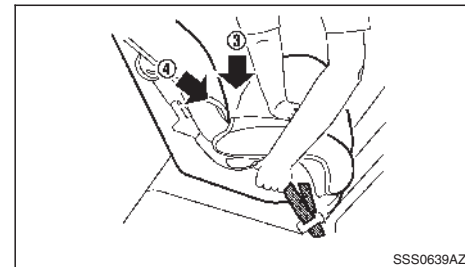

Rear-facing: Step 4

- Remove any additional slack from the seat belt; press downward ③ and rearward ④ firmly in the centre of the child restraint with your hand to compress the vehicle seat cushion and seatback while pulling up on the seat belt.

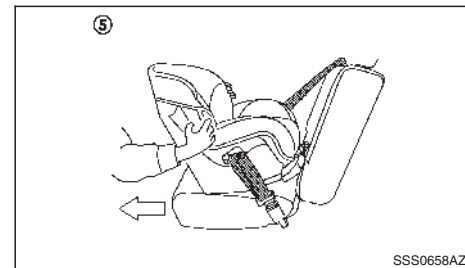

Rear-facing: Step 5

5. Test the child restraint before you place the child in it ⑤. Push the child restraint from side to side and tug it forward to make sure that it is held securely in place.
6. Check to make sure that the child restraint is properly secured prior to each use. If the child restraint is loose, repeat steps 3 through 5.

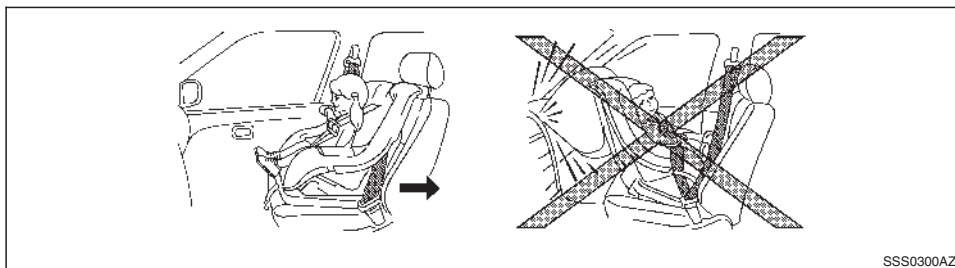

Installation on front passenger's seat



WARNING

Never install a rear-facing child restraint on the front passenger's seat when the front passenger's air bag is available. Supplemental front-impact air bags inflate with great force. A rear-facing child restraint could be struck by the supplemental front-impact air bags in an accident and could seriously injure or kill your child.

Never install a child restraint with a top tether strap on the front seat.

RENAULT recommends that a child restraint be installed on the rear seat (Double Cab models). However, if you must install a child restraint on the front passenger's seat, move the passenger's seat to the rearmost position.

Child restraints for infants must be used in the rear-facing direction and therefore must not be used on the front passenger's seat when the front passenger's air bag is available.

Front-facing child restraint:

Be sure to follow the child restraint manufacturer's instructions for the proper use of your child restraint. Follow these steps to install a front-facing child restraint on the front passenger's seat using three-point type seat belt without automatic locking mode:

If you must install a front-facing child restraint system on the front seat, follow these steps:

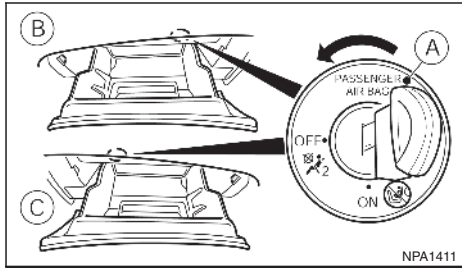

- (A) Air bag switch
- (B) Left Hand Drive models
- (C) Right Hand Drive models

The front passenger air bag can be turned off with the front passenger air bag switch (A) located inside the glove box.



1. Turn off the front passenger air bag by inserting the emergency/mechanical key into the front passenger air bag switch (A) and turning it to the OFF position, see "Mechanical key" in the "3. Pre-driving checks and adjustments" section and "Front passenger air bag status light (where fitted)" later in this section. Place the ignition switch in the **ON** position and make sure that the front air bag status light  on the centre console illuminates.

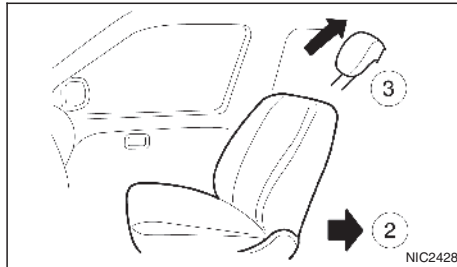

Steps 2 and 3

2. Move the seat to the rearmost position (2).
3. Remove the head restraint (3) when a forward facing child restraint is to be fitted.

Store the head restraint in a safe place.

Be sure to reinstall the head restraint whenever the child restraint is removed (see "Head restraints" earlier in this section).

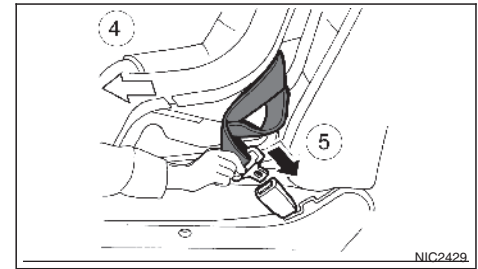

Front-facing: Step 4 and 5

4. Position the child restraint in the seat (4).
5. Route the seat belt tongue through the child restraint and insert it into the buckle (5) until you hear and feel the latch engage.

To prevent slack in the seat belt webbing, it is necessary to secure the seat belt in place with locking devices attached to the child restraint.

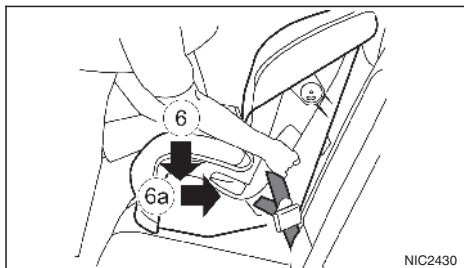

Step 6

6. Remove any additional slack from the seat belt; press downward (6) and rearward (6a) firmly in the centre of the child restraint with your knee to compress the vehicle seat cushion and seatback while pulling up on the seat belt.

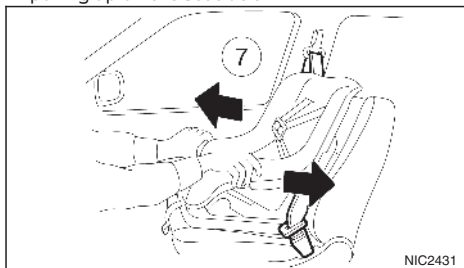

Step 7

7. Test the child restraint before you place the child in it (7). Push the child restraint from side to side and tug it forward to make sure that it is held securely in place.

8. Check to make sure that the child restraint is properly secured prior to each use. If the child restraint is loose, repeat steps 1 through 7.

Rear-facing child restraint:

Be sure to follow the child restraint manufacturer's instructions for the proper use of your child restraint. Follow these steps to install a front-facing child restraint on the front passenger's seat using three-point type seat belt without automatic locking mode:

If you must install a rear-facing child restraint system on the front seat, follow these steps:

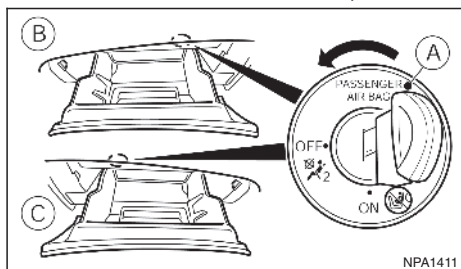

- (A) Air bag switch
- (B) Left Hand Drive models
- (C) Right Hand Drive models

The front passenger air bag can be turned off with the front passenger air bag switch (A) located inside the glove box.



1. Turn off the front passenger air bag by inserting the emergency/mechanical key into the front passenger air bag switch (A), see "Mechanical key" in the "3. Pre-driving checks and adjustments" section and "Front passenger air bag status light (where fitted)" later in this section. Place the ignition switch in the ON position and make sure that the front air bag status light  on the centre console illuminates.

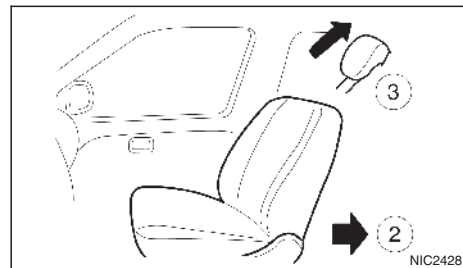

Steps 2 and 3

2. Move the seat to the rearmost position (2).

SUPPLEMENTAL RESTRAINT SYSTEM (SRS) (where fitted)

PRECAUTIONS ON SUPPLEMENTAL RESTRAINT SYSTEM (SRS)

This Supplemental Restraint System (SRS) section contains important information concerning the driver's and passenger's supplemental front-impact air bags, supplemental driver's knee air bag (where fitted), supplemental side-impact air bags (where fitted), supplemental curtain side-impact air bags (where fitted) and pre-tensioner seat belts (where fitted).

Supplemental front-impact air bag system

This system can help cushion the impact force to the head and chest area of the driver and/or front passenger in certain frontal collisions. The supplemental front-impact air bag is designed to inflate on the front where the vehicle is impacted.

Supplemental driver's knee air bag system (where fitted)

This system can help cushion the impact force to the knee area of the driver in certain frontal collisions. The supplemental driver's knee air bag is designed to inflate on the front where the vehicle is impacted.

Supplemental side-impact air bag system (where fitted)

This system can help cushion the impact force to the chest and pelvis area of the driver and front passenger in certain side-impact collisions. The supplemental side-impact air bag is designed to inflate on the side where the vehicle is impacted.

- Adjust the head restraint to its highest position ③. Remove it if it interferes with the child restraint installation. In such situations, securely store the head restraint so that it does not become a dangerous projectile during a sudden stop or in an accident.
- Position the child restraint system in the front passenger seat.
Always follow the child seat manufacturer's instructions for installation and use.
- Test the child restraint before you place the child in it. Push the child restraint from side to side and tug it forward to make sure that it is held securely in place.

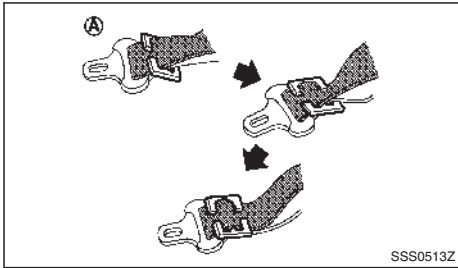

- Route the seat belt tongue through the child restraint system and insert it into the buckle until you hear and feel the latch engage. To prevent slack in the lap belt, secure the shoulder belt in place with a locking clip ①. Use a locking clip attached to the child restraint system, or one which is equivalent in dimensions and strength.

Be sure to follow the child restraint system manufacturer's instructions for belt routing.

Supplemental curtain side-impact air bag system (where fitted)

This system can help cushion the impact force to the head of the driver and passengers in front seating positions and rear outboard seating positions (where fitted) in certain side-impact collisions. The supplemental curtain side-impact air bag is designed to inflate on the side where the vehicle is impacted.

The SRS is designed to **supplement** the accident protection provided by the driver's and passenger's seat belts and **is not** designed to **substitute** for them. The SRS can help save lives and reduce serious injuries. However, inflating air bags may cause abrasions or other injuries. Air bags do not provide protection to the lower body. Seat belts should always be correctly worn and the occupants should always be seated a suitable distance away from the steering wheel, instrument panel and door finishers. (See "Seat belts" earlier in this section.) The air bags inflate quickly in order to help protect the occupants. The force of the air bags inflating can increase the risk of injury if the occupants are too close to, or are against, the air bag modules during inflation. The air bags will deflate quickly after deployment.

The SRS operates only when the ignition switch is in the ON position.

When the ignition switch is in the ON position, the SRS air bag warning light illuminates for about 7 seconds and then turns off. This indicates that the SRS is operational. (See "Warning lights, indicator lights and audible reminders" in the "2. Instruments and controls" section.)

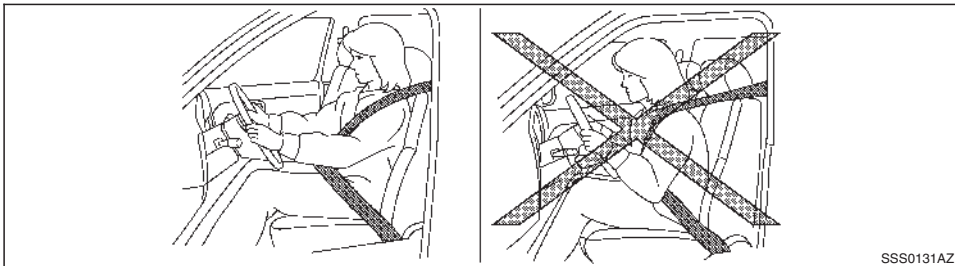

SSS0131AZ

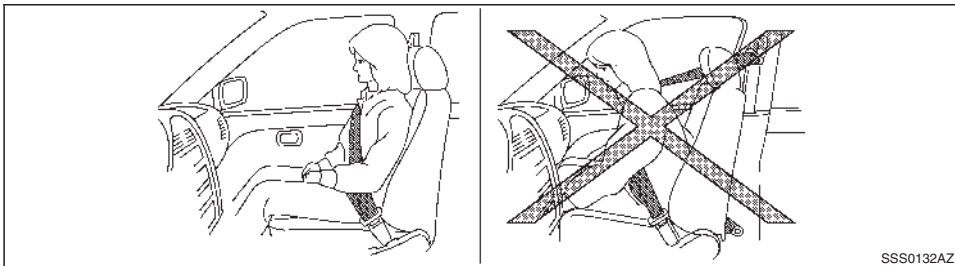

SSS0132AZ



WARNING

The supplemental front air bags ordinarily will not inflate in the event of a side impact, rear impact, rollover, or lower severity frontal collision. Always wear your seat belts to help reduce the risk or severity of injury in various kinds of accidents.

The seat belts and the supplemental front-impact air bags are most effective when you are sitting well back and upright in the seat. The front-impact air bags inflate with great force. If you and your passengers are unrestrained, leaning forward, sitting sideways, or out of position in any way, you and your passengers are at greater risk of injury or death in an accident. You and your passengers may also receive serious or fatal injuries from the supplemental front-impact air bag if you are up against it when it inflates. Always sit back against the seatback and as far away as practical from the steering wheel or instrument panel. Always use the seat belts.

Keep hands on the outside of the steering wheel. Placing them inside the steering wheel rim could increase the risk of injury if the supplemental front air bag inflates.

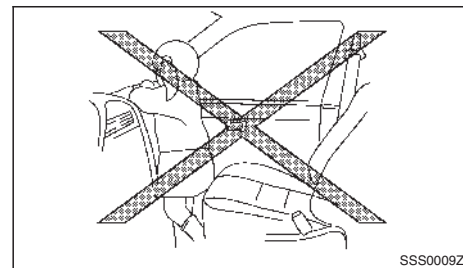
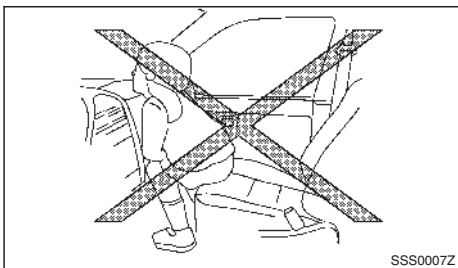
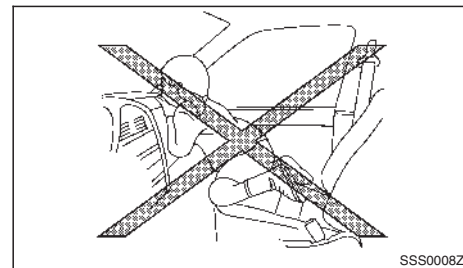
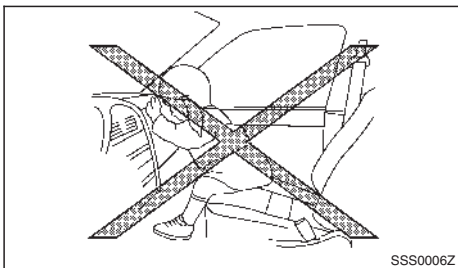

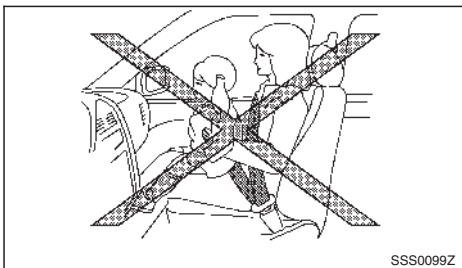

WARNING

Never let children ride unrestrained or extend their hands or face out of the window. Do not attempt to hold them in your lap or arms. Some examples of dangerous riding positions are shown in the illustrations.

Children may be severely injured or killed when the air bags inflate if they are not properly restrained.

Never install a rear-facing child restraint system in the front seat. An inflating supplemental front-impact air bag could seriously injure or kill your child. (See "Child restraints" earlier in this section.)

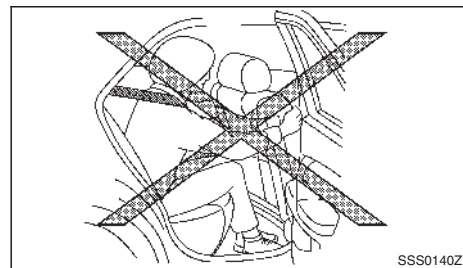
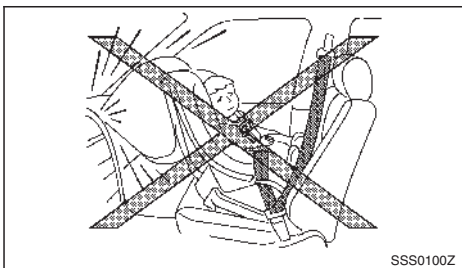
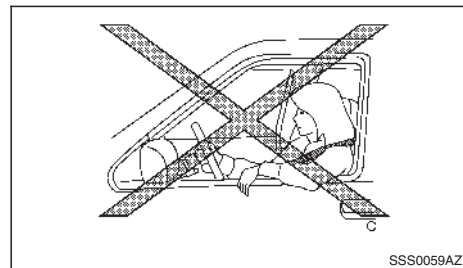

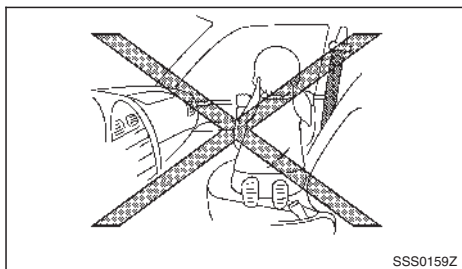

The seat belts and the supplemental side-impact air bags and supplemental curtain side-impact air bags are most effective when you are sitting well back and upright in the seat. The supplemental side-impact air bags and supplemental curtain side-impact air bags inflate with great force. If you and your passengers are unrestrained, leaning forward, sitting sideways, or out of position in any way, you and your passengers are at greater risk of injury or death in an accident.

Do not allow anyone to place their hands, legs or face near the supplemental side-impact air bags and supplemental curtain side-impact air bags located on the sides of the seatback of the front seats or near the side roof rails. Do not allow anyone sitting in the front seats or rear outboard seats to extend their hands out of the windows or lean against the doors. Some examples of dangerous riding positions are shown in the illustrations.

When sitting in the rear seats, do not hold onto the seatback of the front seats. If the supplemental side-impact air bags and supplemental curtain side-impact air bags inflate, you may be seriously injured. Be especially careful with children, who should always be properly restrained.

Do not use seat covers on the front seatbacks. They may interfere with the supplemental side-impact air bag inflations.

Do not attach the key with heavy objects, hard objects or objects with sharp edges. This may cause injury if the supplemental knee air bag inflates.

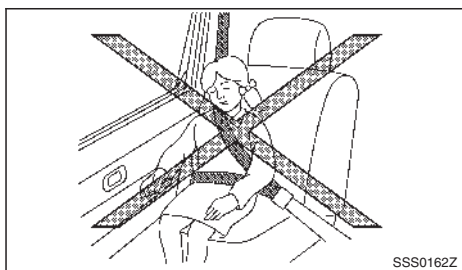

WARNING

The supplemental side-impact air bags (where fitted) and supplemental curtain side-impact air bags (where fitted) ordinarily will not inflate in the event of a front impact, rear impact, rollover, or lower severity side collision. Always wear the seat belts to help reduce the risk or severity of injury in accidents.

Pre-tensioner seat belt system (where fitted)

The pre-tensioner seat belt system may activate with the supplemental air bag system in certain types of collisions. Working with the front seat belt retractors and anchors, it helps tighten the seat belt the instant the vehicle becomes involved in certain types of collisions, helping to restrain front seat occupants. (See "Seat belts" earlier in this section.)

Air bag warning labels

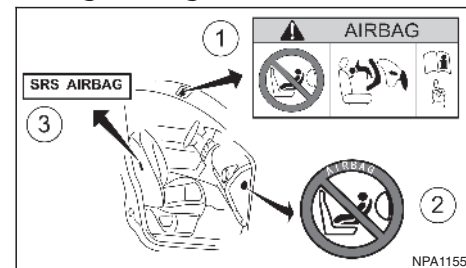

- ① SRS air bag warning label: The warning label is located on the surface of the front passenger sun visor.
- ② SRS front passenger air bag warning label: The warning label is located on the outer side of the instrument panel (passenger side).
- ③ SRS side air bag warning label: The warning label is located on the side of the passenger side centre pillar. Tags are also sewn into the front seat covers.

SRS front-impact passenger air bag:

The warning label ① is located on the sun visor.

“NEVER use a rearward facing child restraint on a seat protected by an ACTIVE AIR BAG in front of it, DEATH or SERIOUS INJURY to the CHILD can occur.”

The BACK SEAT is the SAFEST place for children aged 12 and under. Always use seat belts and child restraints. For maximum safety protection in all types of crashes, you must always wear your safety belt. Do not sit or lean unnecessarily close to the air bag. Do not place any objects over the air bag or between the air bag and yourself. If the air bag warning light stays on or is flashing when the ignition is placed in the ON position, go to an approved dealer or qualified workshop. Air bags can only be removed or disposed of by an approved dealer or qualified workshop.

Be sure to read the “AIR BAG LABEL” description at the end of this manual.

In vehicles equipped with a front-impact passenger air bag system, use a rear-facing child restraint system only on the rear seats.

When installing a child restraint system in your vehicle, always follow the child restraint system manufacturer’s instructions for installation. For additional information, see “Child restraints” earlier in this section.

SRS air bag warning light



The supplemental air bag warning light, displaying  in the instrument panel, monitors the circuits for the air bag systems, pre-tensioner seat belt system (where fitted) and all related wiring.

When the ignition switch is in the “ON” position, the SRS air bag warning light illuminates for about 7 seconds and then turns off. This indicates that the SRS air bag systems are operational.

Have the air bag systems and/or pre-tensioner seat belt systems serviced at the nearest approved dealer or qualified workshop if any of the following conditions occur:

- The SRS air bag warning light remains on after approximately 7 seconds.

- The SRS air bag warning light flashes intermittently.

- The SRS air bag warning light does not illuminate at all.

Under these conditions, the air bag and/or pre-tensioner seat belt system may not operate properly. They must be checked and repaired. Contact an approved dealer or qualified workshop immediately.

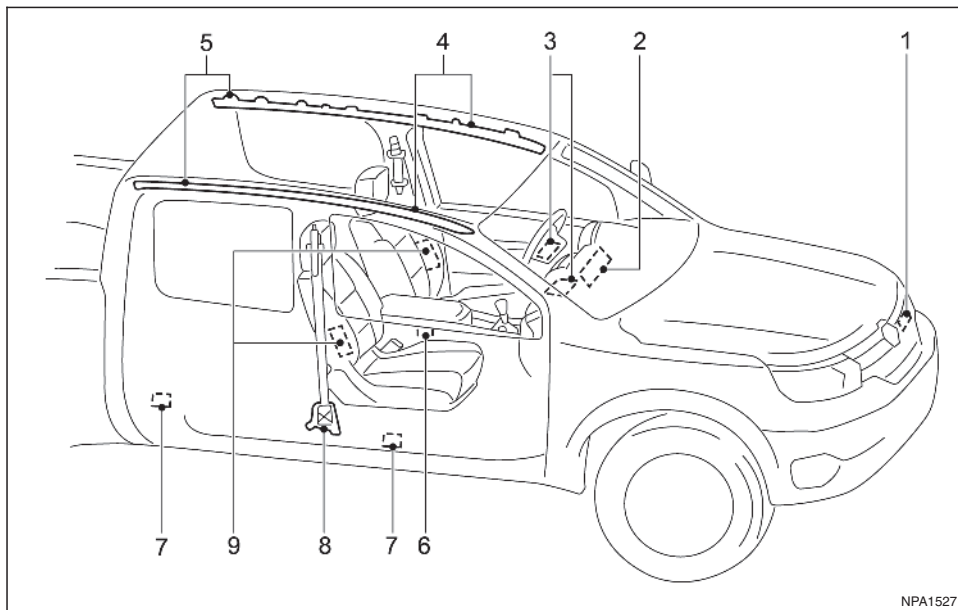

WARNING

Do not place any objects on the steering wheel pad, on the instrument panel, under the steering column and near the front door finishers and the front seats. Do not place any objects between any occupants and the steering wheel pad, on the instrument panel, and near the front door finishers and the front seats. Such objects may become dangerous projectiles and cause injury if a supplemental air bag inflates.

Immediately after inflation, several supplemental air bag system components will be hot. Do not touch them: you may severely burn yourself.

No unauthorised changes should be made to any components or wiring of the supplemental air bag systems. This is to prevent accidental inflation of the supplemental air bags or damage to the supplemental air bag systems.

Do not make unauthorised changes to your vehicle's electrical system, suspension system, front end structure, and side panels. This could affect proper operation of the supplemental air bag systems.

Tampering with the supplemental air bag systems may result in serious personal injury. Tampering includes changes to the steering wheel and the instrument panel by placing materials over the steering wheel pad and above, around or on the instrument panel or by installing additional trim materials around the supplemental air bag systems.

SUPPLEMENTAL AIR BAG SYSTEMS

1. Crush zone sensor
2. Supplemental driver's knee air bag module (where fitted)
3. Supplemental front air bag modules
4. Supplemental curtain side-impact air bag inflators (where fitted)
5. Supplemental curtain side-impact air bag modules (where fitted)
6. Air bag Control Unit (ACU)
7. Satellite sensors (where fitted)
8. Seat belt pre-tensioner retractors (where fitted)
9. Supplemental side-impact air bag modules (where fitted)

Work on and around the supplemental air bag systems should be done by an approved dealer or qualified workshop. The SRS wiring should not be modified or disconnected. Unauthorised electrical test equipment and probing devices should not be used on the supplemental air bag systems.

The SRS wiring harness connectors are yellow for easy identification.

Never install a rear-facing child restraint system on the front passenger seat without first deactivating the passenger air bag with the front passenger air bag switch. In a frontal collision, supplemental front-impact air bags inflate with great force. An inflating supplemental front-impact air bag could seriously injure or kill your child.

When the air bags inflate, a fairly loud noise may be heard, followed by the release of smoke. This smoke is not harmful and does not indicate a fire. Care should be taken not to inhale it, as it may cause irritation and choking. Those with a history of a breathing condition should get fresh air promptly.

Supplemental front-impact air bag system

The driver's supplemental front-impact air bag is located at the centre of the steering wheel. The passenger's supplemental front-impact air bag is located at the instrument panel above the glove box.

The supplemental front-impact air bag system is designed to inflate in higher severity frontal collisions, although it may inflate if the forces in another type of collision are similar to those of a higher severity frontal impact. It may not inflate in certain

frontal collisions. Vehicle damage (or lack of it) is not always an indication of proper supplemental front-impact air bag system operation.



WARNING

Never install a rear-facing child restraint system on the front passenger seat without first deactivating the passenger air bag with the front passenger air bag switch (where fitted), see "Front passenger air bag switch (where fitted)" later in this section. In a frontal collision, supplemental front-impact air bags inflate with great force. An inflating supplemental front-impact air bag could seriously injure or kill your child.



Front passenger air bag status light (where fitted):





WARNING

Since your vehicle is equipped with a front passenger air bag, it is not permitted to install a rearward facing child restraint on the front passenger seat unless the front passenger air bag has been deactivated first.



Do not fit a rearward facing child seat on the front passenger seat if the air bag activation/deactivation system (where fitted) is malfunctioning. Your vehicle must immediately be taken to an approved dealer or qualified workshop in such a situation.

The front passenger air bag status lights  and  are located on the instrument panel between the centre vents.

When the ignition switch is placed in the ON position, the front passenger air bag status ON and OFF lights illuminate and then turn off or remain on depending on the front passenger air bag status.

When the ignition switch is placed in the ON position and the front passenger air bag is active, both the front passenger air bag status OFF light  and the Supplemental Restraint System (SRS) air bag warning light  in the combination meter ① will turn off after about 7 seconds.

The front passenger air bag status ON light  will illuminate and then turn off after a period of time when the front passenger air bag switch is in the ON position.

When the ignition switch is placed in the ON position and the front passenger air bag is inactive, both the front passenger air bag status ON light , and the Supplemental Restraint System (SRS) air bag warning light  in the combination meter ① will turn off after about 7 seconds.

The front passenger air bag status OFF light  will illuminate and remain on as long as the front passenger air bag switch is in the OFF position.

If the front passenger air bag status light operates in a way other than described above, the front passenger air bag may not function properly. Have the system checked, and if necessary repaired, by an approved dealer or qualified workshop promptly.

Front passenger air bag switch (where fitted):

The front passenger air bag can be turned off with the front passenger air bag switch (A) located inside the glove box.

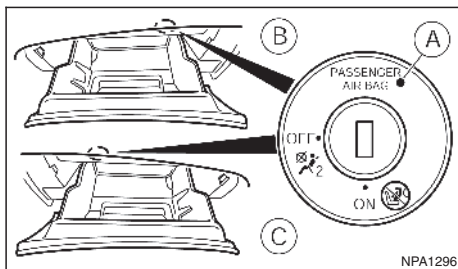

- (A) Air bag switch (where fitted)
- (B) Left Hand Drive models
- (C) Right Hand Drive models

To turn off the front passenger air bag:

1. Place the ignition switch in the **OFF** position.
2. Open the glove box and insert the key into the front passenger air bag switch. For Remote Control Key equipped models, see "Keys" in the "3. Pre-driving checks and adjustments" section for mechanical key usage.
3. Push and turn the key to the <OFF> position.
4. Place the ignition switch in the **ON** position. The front passenger air bag status OFF light  will illuminate and remain on.

To turn on the front passenger air bag:

1. Place the ignition switch in the **OFF** position.
2. Open the glove box and insert the key into the front passenger air bag switch.
3. Push and turn the key to the <ON> position.

4. Place the ignition switch in the **ON** position. The front passenger air bag status ON light  will illuminate, and after a period of time, will then turn off.

Supplemental driver's knee air bag system (where fitted)

The supplemental driver's knee air bag is located under the steering column.

The supplemental driver's knee air bag system is designed to inflate in higher severity frontal collisions, although it may inflate if the forces in another type of collision are similar to those of a higher severity impact. It may not inflate in certain collisions.

Vehicle damage (or lack of it) is not always an indication of proper supplemental driver's knee air bag system operation.

Supplemental side-impact air bag system (where fitted)

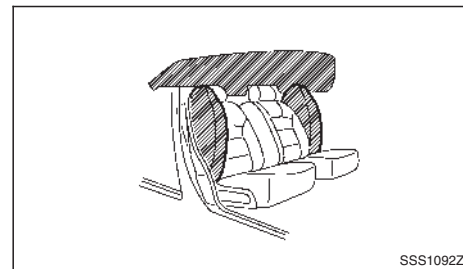

The supplemental side-impact air bag is located at the outside of the front seats' seatbacks.

The supplemental side-impact air bag system is designed to inflate in higher severity side collisions, although it may inflate if the forces in another type of collision are similar to those of a higher severity side impact. It may not inflate in certain side collisions. Vehicle damage (or lack of it) is not always an indication of proper supplemental side-impact air bag system operation.

Supplemental curtain side-impact air bag system (where fitted)

The supplemental curtain side-impact air bag is located at the roof rails.

The supplemental curtain side-impact air bag system is designed to inflate in higher severity side collisions, although it may inflate if the forces in another type of collision are similar to those of a higher severity side impact. It may not inflate in certain side collisions. Vehicle damage (or lack of it) is not always an indication of proper supplemental curtain side-impact air bag system operation.

PRE-TENSIONER SEAT BELT SYSTEM (where fitted)



WARNING

The pre-tensioner seat belt cannot be reused after activation. It must be replaced together with the retractor and buckle as a unit.

If the vehicle becomes involved in a collision but the pre-tensioner is not activated, be sure to have the pre-tensioner system checked and, if necessary, replaced by an approved dealer or qualified workshop.

No unauthorised changes should be made to any components or wiring of the pre-tensioner seat belt system. This is to prevent accidental activation of the pre-tensioner seat belt or damage to the pre-tensioner seat belt system.

Work around or on the pre-tensioner seat belt system should be done by an approved dealer or qualified workshop. The SRS wiring should not be modified or disconnected. Unauthorised electrical test equipment and probing devices should not be used on the pre-tensioner seat belt system.

If you need to dispose of the pre-tensioner seat belt system, or scrap the vehicle, contact an approved dealer or qualified workshop. Correct pre-tensioner disposal procedures are set forth in the appropriate maintenance service manual. Incorrect disposal procedures could cause personal injury.

The pre-tensioner is encased with the front seat belt's retractor and anchor. These seat belts are used the same as conventional seat belts.

When the pre-tensioner seat belt activates, a fairly loud noise may be heard, followed by the release of smoke. This smoke is not harmful and does not indicate a fire. Care should be taken not to inhale it, as it may cause irritation and choking. Those with a history of a breathing condition should get fresh air promptly.

REPAIR AND REPLACEMENT PROCEDURE



WARNING

Once the supplemental front-impact air bags have been inflated, the air bag modules will not function and must be replaced. The air bag modules must be replaced by an approved dealer or qualified workshop. The inflated air bag modules cannot be repaired.

The air bag systems should be inspected by an approved dealer or qualified workshop if there is any damage to the vehicle.

If you need to dispose of the SRS or scrap the vehicle, contact an approved dealer or qualified workshop. Correct disposal procedures are set forth in the appropriate maintenance service manual. Incorrect disposal procedures could cause personal injury.

The supplemental front-impact air bags and pre-tensioner seat belts (where fitted) are designed to activate on a one-time-only basis. As a reminder, unless the SRS air bag warning light is damaged, the SRS air bag warning light remains illuminated after inflation has occurred. The repair and replacement of the SRS should be done only by an approved dealer or qualified workshop.

When maintenance work is required on the vehicle, information about the air bags, pre-tensioner seat belts and related parts should be pointed out to the person performing the maintenance. The ignition switch should always be in the "LOCK" position when working under the bonnet or inside the vehicle.

2 Instruments and controls

Meters and gauges.....	2-2	Defogger switch (where fitted).....	2-29
Speedometer and Fuel gauge.....	2-2	Headlight cleaner (where fitted).....	2-30
Tachometer and Engine coolant temperature gauge.....	2-3	Headlight cleaner switch (where fitted).....	2-30
Instrument brightness control.....	2-4	Horn.....	2-31
Warning lights, indicator lights and audible reminders.....	2-5	Windows.....	2-31
Checking lights.....	2-6	Manual windows (where fitted).....	2-31
Warning lights.....	2-6	Power windows (where fitted).....	2-31
Indicator lights.....	2-10	Power outlets.....	2-33
Audible reminders.....	2-12	Storage.....	2-34
Vehicle information display.....	2-12	Glove box.....	2-34
How to use the Vehicle Information Display.....	2-13	Console box.....	2-35
Settings.....	2-13	Sunglasses holder.....	2-34
Trip computer.....	2-17	Console side pockets.....	2-35
Indicators for operation.....	2-21	Cup holders (where fitted).....	2-35
Oil control system (where fitted).....	2-24	Roof rails (where fitted).....	2-35
Clock and outside air temperature (where fitted).....	2-25	Card holder (where fitted).....	2-36
Headlight and turn signal switch.....	2-26	Sun visors.....	2-36
Headlight switch.....	2-26	Sunroof (where fitted).....	2-37
Headlight aiming control (where fitted).....	2-27	Automatic sunroof.....	2-37
Battery saver system (where fitted).....	2-27	Interior lights.....	2-38
Turn signal switch.....	2-27	Interior light switch (where fitted).....	2-38
Fog light switch (where fitted).....	2-28	Console light (where fitted).....	2-38
Front fog lights (where fitted).....	2-28	Map lights.....	2-38
Rear fog light (where fitted).....	2-28	Map light control switch (where fitted).....	2-38
Wiper and washer switch.....	2-29	Room light (where fitted).....	2-39
Windscreen wiper and washer switch.....	2-29	Rear personal light (where fitted).....	2-39
		Vanity mirror lights (where fitted).....	2-39
		Battery saver system.....	2-40

METERS AND GAUGES

NOTE

For an overview see “Meters and gauges” in the “0. Illustrated table of contents” section and see “Instrument panel” in the “0. Illustrated table of contents” section.

The needle indicators may move slightly after the ignition switch is placed in the OFF position. This is not a malfunction.

SPEEDOMETER AND FUEL GAUGE

Speedometer

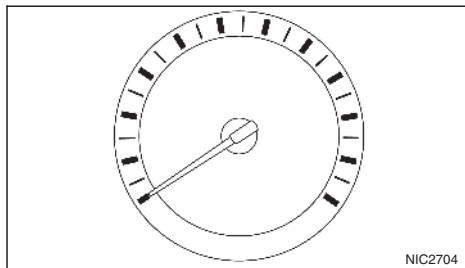

The speedometer indicates the vehicle speed.

Fuel gauge

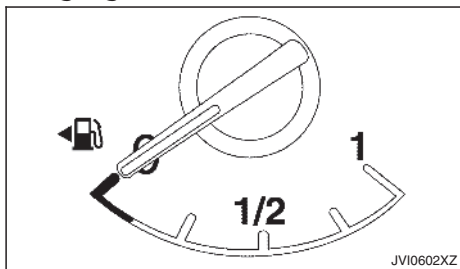

The fuel gauge indicates the approximate fuel level in the tank when the ignition switch is in the ON position.

The gauge may move slightly during braking, turning, accelerating, or going up and down hills due to movement of fuel in the tank.

The low fuel warning appears on the vehicle information display when the fuel level in the tank is getting low. Refuel as soon as it is convenient, preferably before the gauge reads the empty (0) position.

The arrow, , indicates that the fuel filler lid is located on the left side of the vehicle.

CAUTION

Refuel before the gauge reads the empty (0) position.

There is a small reserve of fuel in the tank when the fuel gauge reads the empty (0) position.

Odometer

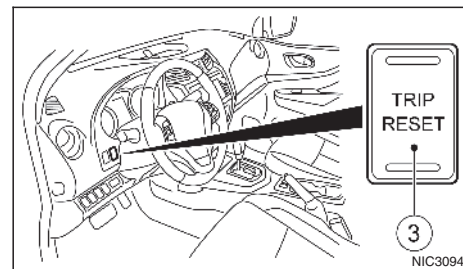
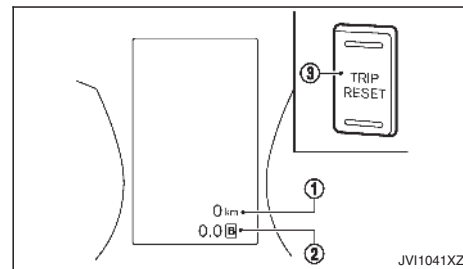

Left Hand Drive (LHD) model

Distance to empty (dte — km or mile):

The distance to empty (dte) ① provides you with an estimation of the distance that can be driven before refuelling. The dte is constantly being calculated, based on the amount of fuel in the fuel tank and the actual fuel consumption.

The display is updated every 30 seconds.

The dte mode includes a low range warning feature. If the fuel level is low, the warning is displayed on the screen.

When the fuel level drops even lower, the dte display will change to “—”.

If the amount of fuel added is small, the distance to empty shown just before the ignition switch is placed in the “OFF” position may continue to be displayed.

When driving uphill or rounding curves, the fuel in the tank shifts, which may momentarily change the display.

Odometer/Twin trip odometer:

The odometer/twin trip odometer is displayed in the vehicle information display when the ignition switch is in the ON position.

The odometer ① displays the total distance the vehicle has been driven.

The twin trip odometer ② displays the distance of individual trips.

Changing twin trip odometer display:

Push the <TRIP RESET> switch ③ (located on the instrument panel) to change the display as follows:

TRIP A → TRIP B → ODOMETER → TRIP A

Resetting twin trip odometer:

Push and hold the <TRIP RESET> switch ③ for more than 1 second to reset the trip odometer to zero.

Odometer (models without colour display)

Odometer/twin trip odometer:

The odometer/twin trip odometer is displayed when the ignition switch is in the ON position.

The odometer ① displays the total distance the vehicle has been driven.

The twin trip odometer ② displays the distance of individual trips.

Changing trip odometer display:

Push the trip odometer reset switch ③ to change the display as follows:

TRIP A → TRIP B → Trip computer mode → TRIP A

For trip computer information, see “Trip computer” later in this section.

Resetting trip odometer:

While TRIP A or TRIP B is displayed push and hold the trip odometer reset switch ③ for approximately 1 second to reset the trip odometer to zero.

For further information, see “Trip computer” later in this section.

TACHOMETER AND ENGINE COOLANT TEMPERATURE GAUGE

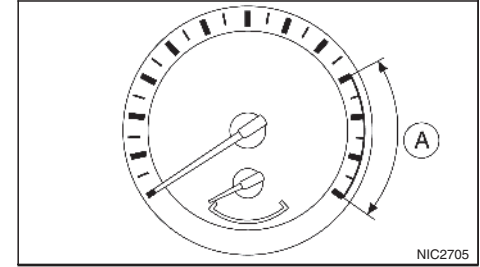

The tachometer indicates the engine speed in revolutions per minute (rpm). **Do not rev the engine into the red zone A.**

The red zone varies with models.

Engine coolant temperature gauge

The engine coolant temperature gauge indicates the engine coolant temperature.

The engine coolant temperature is normal when the gauge needle points within the zone ① shown in the illustration.

The engine coolant temperature will vary with the outside air temperature and driving conditions.

INSTRUMENT BRIGHTNESS CONTROL

Instrument brightness control button
(models with colour display)

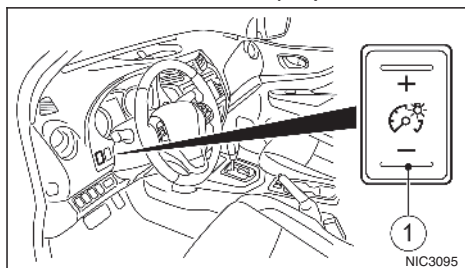

Left Hand Drive (LHD) model

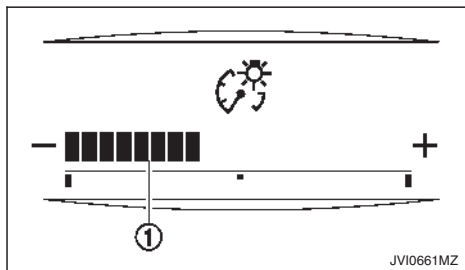

The instrument brightness control switch ① can be operated when the ignition switch is in the ON position. When the switch is operated, the vehicle information display switches to the brightness adjustment mode.



































Push the + side of the switch to brighten the meter panel lights. The bar ① moves to the + side.

Push the - side of the switch to dim the lights. The bar ① moves to the - side.

When the brightness level reaches the maximum or minimum, a beep will sound.





The vehicle information display returns to the normal display when the instrument brightness control switch is not operated for more than 5 seconds.









WARNING LIGHTS, INDICATOR LIGHTS AND AUDIBLE REMINDERS

	Anti-lock Braking System (ABS) warning light*		Four-Wheel Drive (4WD) warning light (4WD model)		DPF
	Active Emergency Braking system warning light*		Low fuel warning light		Front passenger air bag status light
	Automatic Transmission (AT) check warning light (AT model)		Low washer fluid warning light*		Glow plug indicator light*
	Automatic Transmission (AT) oil temperature warning light (AT model)		Malfunction warning light (red)*		High beam indicator light
	Automatic Transmission (AT) park warning light (AT model)		Master warning light*		Hill descent control system on indicator light*
	Brake warning light		Seat belt warning light*		Malfunction Indicator Light (MIL)
	Charge warning light		Supplemental Restraint System (SRS) air bag warning light*		Rear fog light indicator light*
	Diesel Particulate Filter (DPF) warning light*		Water-in-fuel-filter warning light*		Security indicator light*
	Door open warning light		Differential lock indicator light*		Small light indicator light*
	Electronic Stability Programme (ESP) warning light*		Dipped beam indicator light		Trailer direction indicator light*
	Engine oil pressure warning light		Electronic Stability Programme (ESP) off indicator light*		Turn signal indicator/hazard warning lights
	Engine temperature warning light (red or blue)*		Front fog light indicator light*		

*: where fitted

CHECKING LIGHTS

With all doors closed, apply the parking brake, fasten the seat belts and place the ignition switch in the ON position without starting the engine. The following lights (where fitted) will come on: , , , . 4WD.

The following lights (where fitted) will come on briefly and then go off: , , . **ATP**, , , , , ,  (red and blue)

If any light does not come on, or operates in a way other than described it may indicate a burned-out bulb and/or a system malfunction. Have the system checked, and if necessary repaired, by an approved dealer or qualified workshop promptly.

Models with colour display:

Some indicators and warnings are also displayed on the vehicle information display between the speedometer and tachometer. (See "Indicators for operation" later in this section.)

WARNING LIGHTS



Anti-lock Braking System (ABS) warning light (where fitted)

When the ignition switch is in the ON position, the Anti-lock Braking System (ABS) warning light illuminates and then turns off. This indicates the ABS is operational.

If the ABS warning light illuminates while the engine is running, or while driving, it may indicate the ABS is not functioning properly. Have the system checked by an approved dealer or qualified workshop promptly.

If an ABS malfunction occurs, the anti-lock function is turned off. The brake system then operates normally, but without anti-lock assistance. (See "Anti-lock Braking System (ABS)" in the "5. Starting and driving" section.)

While the differential lock (where fitted) is engaged, the ABS warning light illuminates. This indicates that the anti-lock function is not fully operating. (See "Rear differential locking system (where fitted)" in the "5. Starting and driving" section for the rear differential lock function.)



Active Emergency Braking system warning light (where fitted)

This light illuminates when the Active Emergency Braking system is set to OFF on the lower display.

If the light illuminates when the Active Emergency Braking system is ON, it may indicate that the system is unavailable. See "Active Emergency Braking system (where fitted)" in the "5. Starting and driving" section for more details.

Disabling the ESP system with the Electronic Stability Programme (ESP) OFF switch causes the Active Emergency Braking system to become unavailable. This is not a malfunction.

For models without colour display:

The warning light blinks when the Active Emergency Braking system is operating.



Automatic Transmission (AT) check warning light (AT model)

When the ignition switch is in the ON position, the Automatic Transmission (AT) check warning light illuminates and then turns off. This indicates that the AT is operational.

If the AT check warning light illuminates while the engine is running, or while driving, it may indicate that the AT is not functioning properly and may need servicing. Have the system checked, and if necessary repaired, by an approved dealer or qualified workshop promptly.



Automatic Transmission (AT) oil temperature warning light (AT model)

This light illuminates when the Automatic Transmission (AT) oil temperature is too high. If the light illuminates while driving, reduce the vehicle speed as soon as safely possible until the light turns off.

CAUTION

Continued vehicle operation when the AT oil temperature warning light is on may damage the AT.



Automatic Transmission (AT) park warning light (AT model)

This light indicates that the Automatic Transmission (AT) parking function is not engaged. If the transfer control is not secured in any driving position while the AT shift lever is in the P (Park) position, the transmission will disengage and the wheels will not lock.

For 4WD model: If the ATP warning light illuminates with the shift lever in the P (Park) position, shift the Four-Wheel Drive (4WD) mode switch to the 2WD, 4H or 4LO position again with the shift lever in the N (Neutral) position. (See “4WD mode switch operation” in the “5. Starting and driving” section.)



WARNING

If the 4WD mode indicator (see “Four-Wheel Drive (4WD) warning light (4WD model)” later in this section) is OFF or the ATP warning light is ON, this indicates that the automatic transmission P (Park) position will not function and could result in the vehicle moving unexpectedly, causing serious personal injury or property damage. Always set the parking brake.



Brake warning light



WARNING

If the brake fluid level is below the minimum mark on the brake fluid reservoir, do not drive the vehicle until the brake system has been checked by an approved dealer or qualified workshop.

Even if you judge it to be safe, have your vehicle towed because driving it could be dangerous.

Depressing the brake pedal without the engine running and/or with a low brake fluid level could increase the stopping distance and require greater pedal travel distance and effort.

The brake warning light indicates the parking brake system operation, a low brake fluid level of the brake system and an Anti-lock Braking System (ABS) malfunction.

Parking brake warning indicator:

When the ignition switch is placed in the ON position, the brake warning light illuminates. When the engine is started and the parking brake is released, the brake warning light turns off.

If the parking brake is not fully released, the brake warning light remains on. Be sure that the brake warning light has turned off before driving. (See “Parking brake” in the “3. Pre-driving checks and adjustments” section.)

Low brake fluid warning indicator:

If the brake warning light illuminates while the engine is running, or while driving, and the parking brake is released, it may indicate the brake fluid level is low.

When the brake warning light illuminates while driving, stop the vehicle safely as soon as possible. Stop the engine and check the brake fluid level. If the brake fluid level is at the minimum mark, add brake fluid as necessary. (See “Brake fluid” in the “8. Maintenance and do-it-yourself” section.)

If the brake fluid level is sufficient, have the brake system checked by an approved dealer or qualified workshop promptly.

Anti-lock Braking System (ABS) warning indicator (where fitted):

When the parking brake is released and the brake fluid level is sufficient, if both the brake warning light and the Anti-lock Braking System (ABS) warning

light illuminate, it may indicate the ABS is not functioning properly. Have the brake system checked, and if necessary repaired, by an approved dealer or qualified workshop promptly. (See “Brake system” in the “5. Starting and driving” section.)



Charge warning light

When the ignition switch is in the ON position, the charge warning light illuminates. After starting the engine, the charge warning light turns off. This indicates that the charging system is operational.

If the charge warning light illuminates while the engine is running, or while driving, it may indicate that the charging system is not functioning properly and may need servicing.

When the charge warning light illuminates while driving, stop the vehicle safely as soon as possible. Stop the engine and check the alternator belt. If the alternator belt is loose, broken or missing, contact an approved dealer or qualified workshop promptly. (See “Drive belt” in the “8. Maintenance and do-it-yourself” section.)

If the alternator belt appears to be functioning correctly but the charge warning light remains illuminated, have the charging system checked by an approved dealer or qualified workshop promptly.

CAUTION

Do not continue driving if the alternator belt is loose, broken or missing.



Diesel Particulate Filter (DPF) warning light (where fitted)

When the DPF warning light illuminates, it indicates that particulate matter is accumulated to the specified amount of the limit in the filter and the filter needs to regenerate. For filter regeneration details, see "Diesel Particulate Filter (DPF) (where fitted)" in the "5. Starting and driving" section.

CAUTION

If you continue driving with the DPF warning light on without performing the filter regeneration, this will lead to particulate matter overload in the filter.

If this occurs, then the Malfunction Indicator Light (MIL) will turn on. The performance of the engine might be limited to protect the DPF system. See an approved dealer or qualified workshop to perform the service regeneration.



Door open warning light

When the ignition switch is in the ON position, the door open warning light illuminates if any of the doors are open or not closed securely.



Electronic Stability Programme (ESP) warning light (where fitted)

When the ignition switch is in the ON position, the Electronic Stability Programme (ESP) warning light illuminates and then turns off.

The warning light blinks when the ESP system is operating.

When the warning light blinks while driving, the driving condition is slippery and the vehicle's traction limit is about to be exceeded.

If the ESP warning light illuminates while the engine is running or while driving, it may indicate that the ESP system is not functioning properly and may need servicing. Have the system checked, and if necessary repaired, by an approved dealer or qualified workshop promptly. If a malfunction occurs, the ESP function is turned off, but the vehicle is still drivable. (See "Electronic Stability Programme (ESP) system (where fitted)" in the "5. Starting and driving" section.)



Engine oil pressure warning light

When the ignition switch is in the ON position, the engine oil pressure warning light illuminates. After starting the engine, the engine oil pressure warning light turns off. This indicates that the oil pressure sensors in the engine are operational.

If the engine oil pressure warning light illuminates or blinks while the engine is running, it may indicate that the engine oil pressure is low.

Stop the vehicle safely as soon as possible. Stop the engine immediately and call an approved dealer or qualified workshop.

CAUTION

Running the engine with the engine oil pressure warning light illuminated could cause serious damage to the engine.

The engine oil pressure warning light is not designed to indicate a low oil level. The oil level should be checked using the dipstick. (See

"Checking engine oil level" in the "8. Maintenance and do-it-yourself" section.)



Engine temperature warning light (red/blue) (where fitted)

High temperature indicator light (red):

The red warning light comes on when the engine overheats.



WARNING

If the high temperature warning light illuminates while the engine is running, it may indicate the engine temperature is extremely high. Stop the vehicle safely as soon as possible. If the vehicle is overheated, continuing vehicle operation may seriously damage the engine.

If the engine coolant temperature warning light (red) comes on while driving, stop the vehicle as soon as possible and contact an approved dealer or qualified workshop.

When towing a trailer or driving uphill, reduce the vehicle speed as soon as safely possible to decrease the engine coolant temperature.

If the engine overheats, continued operation of the vehicle may seriously damage the engine. See "If your vehicle overheats" in the "6. In case of emergency" section for immediate required action.

Low temperature indicator light (blue):

When the ignition switch is placed in the ON position, the engine temperature warning light (blue) comes on. After a few seconds, it should go out and remain off while the engine is running.

4WD Four-Wheel Drive (4WD) warning light (4WD model)

When the ignition switch is in the ON position, the Four-Wheel Drive (4WD) warning light illuminates. After starting the engine, the 4WD warning light turns off.

If the 4WD system malfunctions or the revolution or radius of the front and the rear wheel differs, the warning light will either remain illuminated or blink. (See "Four-Wheel Drive (4WD) (where fitted)" in the "5. Starting and driving" section.)

CAUTION

If the 4WD warning light illuminates or blinks while driving, reduce the vehicle speed and have your vehicle checked by an approved dealer or qualified workshop as soon as possible.

If the Four-Wheel Drive (4WD) warning light turns on when driving on dry hard surface roads:

- **in the 4H position, shift the 4WD mode switch to 2WD.**
- **in the 4LO position, stop the vehicle and shift the transmission lever to the N (Neutral) position with the brake pedal depressed and shift the 4WD mode switch to 2WD.**

If the warning light is still on after the above operations, have your vehicle checked by an approved dealer or qualified workshop as soon as possible.



Low fuel warning light

The low fuel warning light illuminates when the fuel level in the tank is getting low. Refuel as soon as it is convenient, preferably before the fuel gauge reaches the empty (0) position.

There will be a small reserve of fuel remaining in the tank when the fuel gauge reaches the empty (0) position.



Low washer fluid warning light (where fitted)

The low washer fluid warning light illuminates when the washer fluid in the reservoir is at a low level. Add washer fluid as necessary. (See "Window washer fluid" in the "8. Maintenance and do-it-yourself" section.)



Malfunction warning light (red) (where fitted)

When the ignition switch is placed in the ON position, the malfunction warning light illuminates in red. This means that the system is operational. After starting the engine, the warning light turns off.

For the orange Malfunction Indicator Light (MIL), see "Malfunction Indicator Light (MIL)" later in this section for details.

If the malfunction warning light (red) illuminates continuously while the engine is running, it may indicate an engine control system malfunction. Have your vehicle inspected by an approved dealer or qualified workshop. You do not need to have your vehicle towed to the dealer.

CAUTION

Continuing vehicle operation without proper servicing of the engine control system could lead to poor driveability, reduced fuel economy, and damage to the engine control system, which may affect the vehicle's warranty coverage.



Master warning light (where fitted)

When the ignition switch is in the ON position, the master warning light illuminates if any of the following are displayed on the vehicle information display.

- No Key Detected warning (where fitted)
- Shift to Park warning (Automatic Transmission (AT) models)
- Key ID Incorrect warning (where fitted)
- Release Parking Brake warning
- Low fuel warning
- Door open warning
- Low Washer warning (where fitted)
- Key System Error warning (where fitted)
- Low Oil Pressure warning (where fitted)
- AdBlue® warning (where fitted)
- 4WD Error (where fitted)
- Shipping Mode On Push Storage Fuse warning (where fitted)
- Headlight System Error warning (where fitted)
- Automatic Transmission (AT) Error warning (Automatic Transmission (AT) models)
- Parking Sensor Error (where fitted)

See "Vehicle information display" later in this section.



Seat belt warning light (where fitted)

Front seat belts:

When the ignition switch is in the ON position, the seat belt warning light illuminates. The light will continue to illuminate until the driver's seat belt is fastened.



Supplemental Restraint System (SRS) air bag warning light (where fitted)

When the ignition switch is in the ON position, the Supplemental Restraint System (SRS) air bag warning light illuminates for about 7 seconds and then turns off. This indicates the SRS air bag system is operational.

If any of the following conditions occur, the SRS air bag system and/or pre-tensioner seat belt (where fitted) need servicing. Have the system checked, and if necessary repaired, by an approved dealer or qualified workshop promptly.

The SRS air bag warning light remains illuminated after about 7 seconds.

The SRS air bag warning light flashes intermittently.

The SRS air bag warning light does not come on at all.

Unless checked and repaired, the SRS air bag system and/or pre-tensioner seat belt may not function properly. (See "Supplemental Restraint System

(SRS) (where fitted)" in the "1. Safety — seats, seat belts and supplemental restraint system" section.)



Water-in-fuel-filter warning light (where fitted)

If the water-in-fuel-filter warning light illuminates while the engine is running, contact an approved dealer or qualified workshop as soon as possible.

CAUTION

Continuing vehicle operation without properly draining could cause serious damage to the engine.

INDICATOR LIGHTS



Differential lock indicator light (where fitted)

When the differential lock mode switch is in the ON position, the differential lock indicator light will blink and then stay on after the differential gear is completely locked.

See "Rear differential locking system (where fitted)" in the "5. Starting and driving" section.



Dipped beam indicator light (where fitted)

The dipped beam indicator light illuminates when the headlight low beam is on. (See "Headlight and turn signal switch" later in this section.)



Electronic Stability Programme (ESP) off indicator light

The Electronic Stability Programme (ESP) off indicator light illuminates when the ESP OFF switch is pushed to the OFF position.

When the ESP OFF switch is pushed to the OFF position, the ESP system is turned off.

When the rear differential lock is engaged with the differential lock mode switch or the <4LO> position is selected with the Four-Wheel Drive (4WD) mode switch, the ESP system is disabled and the ESP off indicator light illuminates. (See "Electronic Stability Programme (ESP) system (where fitted)" in the "5. Starting and driving" section and "Rear differential locking system (where fitted)" in the "5. Starting and driving" section.)





Front fog light indicator light (where fitted)

The front fog light indicator light illuminates when the front fog lights are on. (See "Fog light switch (where fitted)" later in this section.)



Front passenger air bag status light

The front passenger air bag status light () located on the instrument panel will illuminate when the front passenger air bag is turned off with the front passenger air bag switch. When the front passenger air bag is turned on, the front passenger air bag status light () will illuminate.

For more details, see "Front passenger air bag status light (where fitted)" in the "1. Safety — seats, seat belts and supplemental restraint system" section.



Glow plug indicator light (where fitted)

When the ignition switch is in the ON position, the glow plug indicator light illuminates and turns off after the glow plugs have warmed up.

If the glow plugs have already warmed up, the glow plug indicator flashes briefly and then turns off.



High beam indicator light

The high beam indicator light illuminates when the headlight high beam is on. The indicator turns off when the low beam is selected. (See “Headlight and turn signal switch” later in this section.)



Hill descent control system on indicator light (where fitted)

When the ignition switch is in the ON position the hill descent control system on indicator light illuminates briefly and then turns off. This indicates that the hill descent control system is operational.

The light illuminates when the hill descent control system is activated.

If the hill descent control switch is on and the indicator light blinks, the system is not engaged.

If the indicator light does not illuminate or blink when the hill descent control switch is on, the system may not be functioning properly. Have the system checked by an approved dealer or qualified workshop.

For additional information, see “Hill descent control system (where fitted)” in the “5. Starting and driving” section.



Malfunction Indicator Light (MIL)

CAUTION

Continuing vehicle operation without proper servicing of the engine control system could lead to poor driveability, reduced fuel

economy, and damage to the engine control system, which may affect the vehicle’s warranty coverage.

Incorrect setting of the engine control system may lead to non-compliance of local and national emission laws and regulations.

When the ignition switch is in the ON position, the Malfunction Indicator Light (MIL) illuminates. After starting the engine, the MIL turns off. This indicates that the engine control system is operational.

If the Malfunction Indicator Light illuminates or blinks while the engine is running, it may indicate that the engine control system is not functioning properly and may need servicing. Have the system checked, and if necessary repaired, by an approved dealer or qualified workshop promptly.

Precautions:

To reduce or avoid possible damage to the engine control system when the MIL blinks:

- Avoid driving at speeds above 70 km/h (43 MPH).
- Avoid sudden acceleration or deceleration.
- Avoid going up steep uphill grades.
- Avoid carrying or towing unnecessary loads.



Rear fog light indicator light (where fitted)

The rear fog light indicator light illuminates when the rear fog light is on. (See “Fog light switch (where fitted)” later in this section.)



Security indicator light (where fitted)

The security indicator light blinks when the ignition switch is in the ACC, OFF or LOCK position. This function indicates that the security system equipped on the vehicle is operational.

If the security system is malfunctioning, this light will remain on while the ignition switch is in the ON position. (See “Security system (where fitted)” in the “3. Pre-driving checks and adjustments” section for additional information.)



Small light indicator light (where fitted)

The light illuminates when the headlight switch is turned to the  position.



Trailer direction indicator light (where fitted)

The light will illuminate whenever an additional electrical load is detected by the direction indicator system.

For additional information, see “Trailer towing” in the “5. Starting and driving” section.



Turn signal/hazard warning lights

The turn signal/hazard warning lights blink when the turn signal switch lever or hazard warning flasher switch is on. (See “Turn signal switch” later in this section or “Hazard warning flasher switch” in the “6. In case of emergency” section.)

AUDIBLE REMINDERS

Brake pad wear warning

The disc brake pads have audible wear warnings. When a brake pad requires replacement, it will make a high pitched scraping sound when the vehicle is in motion. This scraping sound will first occur only when the brake pedal is depressed. After more wear of the brake pad, the sound will always be heard even if the brake pedal is not depressed. Have the brakes checked as soon as possible if the wear warning sound is heard.

Have the system checked, and if necessary repaired, by an approved dealer or qualified workshop promptly. (See "Brakes" in the "8. Maintenance and do-it-yourself" section.)

Key reminder chime

The chime will sound if any of the following operations are detected:



Models with Remote Control Key system:

The chime will sound if the driver side door is opened while the ignition switch is placed in the ACC position.

Models without Remote Control Key system:

The chime sounds if the driver's side door is opened while the key is left in the ignition switch and the ignition switch is in the ACC, OFF or LOCK position. Remove the key and take it with you when leaving the vehicle.

Light reminder chime

The light reminder chime will sound if the driver's side door is opened and the headlight switch is in either the  or  position, and the ignition switch is in the ACC, OFF or LOCK position.

Be sure to turn the headlight switch to the <OFF> or <AUTO> (where fitted) position when you leave the vehicle.

Parking brake reminder chime

The parking brake reminder chime will sound if the vehicle is driven at more than 7 km/h (4 MPH) with the parking brake applied. Stop the vehicle and release the parking brake.

Seat belt warning chime (where fitted)

When the vehicle speed exceeds 15 km/h (10 MPH), the chime will sound unless the driver's and/or the front passenger's seat belts are securely fastened. The chime will continue to sound for about 95 seconds until the seat belt is fastened.

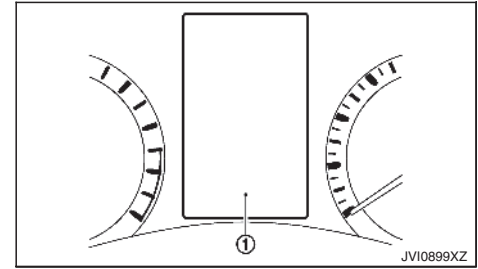

The vehicle information display ① is located between the tachometer and the speedometer, and it displays the warnings and information. The following items are also displayed:

- Automatic Transmission (AT) (where fitted)
 - "Driving with Automatic Transmission (AT)" in the "5. Starting and driving" section
- Four-Wheel Drive (4WD) (where fitted)
 - "Four-Wheel Drive (4WD) (where fitted)" in the "5. Starting and driving" section
- Clock
 - "[Clock]" later in this section
- Trip computer
 - "Trip computer" later in this section
- Cruise control (where fitted)
 - "Cruise control (where fitted)" in the "5. Starting and driving" section
- Remote Control Key system (where fitted)
 - "Remote Control Key system (where fitted)" in the "3. Pre-driving checks and adjustments" section

Oil control system (where fitted)
– “Oil control system (where fitted)” later in this section

HOW TO USE THE VEHICLE INFORMATION DISPLAY

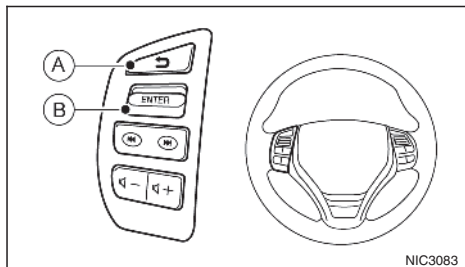

Type A

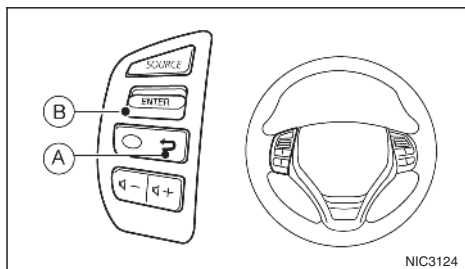

Type B

The vehicle information display can be changed using the <ENTER> and BACK buttons located on the left side of the steering wheel.

↶ Back button (A)

Press the BACK button to return to the previous display screen or menu level, or to cancel the selection if it is not completed.

Display scrolling switch (B)

Push ▲ to scroll up or ▼ to scroll down through the items in the vehicle information display. Press <ENTER> (B) to select an item in the display, then push ▲ or ▼ to scroll through the associated menu options.

SETTINGS

The settings mode allows you to change the information displayed in the vehicle information display:

- [Driver Assistance]
- [Clock]
- [Display Settings]
- [Vehicle Settings]
- [Maintenance]
- [Alert]
- [Units]
- [Language]
- [Factory Reset]

NOTE

The Settings menu cannot be operated while driving.

[Driver Assistance]

Use the ▲ or ▼ switches and the <ENTER> button to change the status, or turn on or off any of the systems displayed in the [Driver Assistance] menu. The following menu options are available:

[Driving Aids] (where fitted):

The [Driving Aids] option has a sub-menu, from which you can choose whether to turn **ON** or **OFF** the following item:

[Emergency Brake]

Select this item to enable/disable the Active Emergency Braking system. For additional information see, “Active Emergency Braking system (where fitted)” in the “5. Starting and driving” section.

[Parking Aids] (where fitted):

The [Parking Aids] option has a sub-menu, from which you can choose the following:

[Sensor]

Select this item to enable/disable the parking sensor (sonar).

[Volume]

Select this sub-menu to change the parking sensor (sonar) buzzer volume to one of the following:

- [High]
Loudest available volume.
- [Med.]
Medium volume. (Standard)
- [Low]
Lowest available volume.

[Range]

Select this sub-menu to change the parking sensor (sonar) detection range to one of the following:

- [Far]
The parking sensor system will give earlier notice of objects further away.
- [Mid.]
The parking sensor system is set to the standard distance.
- [Near]
The parking sensor system will only give notice of objects close by.

[Set Clock] (where fitted)

Select this sub-menu to adjust the time on the clock.

[12Hr/24Hr] (where fitted)

Select this sub-menu to choose the clock format between 12-hour and 24-hour.

[Display Settings]

The following sub-menus are available under the [Display Settings] menu.

[Contents Selection]

[Body Colour]

[ECO Drive Report] (where fitted)

[Welcome Effect]

[Contents Selection]:

Select this sub-menu to enable/disable the items that are displayed.

[Home]

[Average Speed]

[Trip]

[Fuel Economy]

[Navigation] (where fitted)

[Audio]

[Driving Aids] (where fitted)

[Body Colour]:

In this sub-menu you can change the colour of the vehicle displayed in the vehicle information display.

[ECO Drive Report] (where fitted):

There are 2 items in the [ECO Drive Report] menu.

[Display]

Select this item to enable/disable the ECO Drive Report in the vehicle information display.

[View History]

Select this sub-menu to show the fuel economy history, current economy, and the best fuel economy. See, "ECO drive report" in the "5. Starting and driving" section.

- [Back] will return you to the [ECO Drive Report] menu.
- [Reset] will reset the fuel economy history to zero.

[Welcome Effect]:

Select this sub-menu to enable/disable the items described below to **ON** or **OFF**.

[Dial and Pointer]

The indicator needles sweep in the meters when the engine is started.

[Display Effect]

The welcome screen display appears when the ignition is placed in the **ON** position.

[Vehicle Settings]

The following sub-menus are available under the [Vehicle Settings] menu.

[Lighting]

[Turn Indicator]

[Unlocking]

[Wipers]

[Lighting] (where fitted):

There are 2 items under the Lighting menu.

[Int. Lamp Timer]

Select this item to enable/disable the interior lamp timer feature.

The interior lights will be **ON** if any door is unlocked when the interior lamp timer is enabled.

[Auto Lights]

The automatic lighting system can be set to illuminate earlier or later based on the brightness outside the vehicle. See, "Headlight and turn signal switch" in the "2. Instruments and controls" section.

- [On Earliest]
- [On Earlier]
- [Standard]
- [On Later]

[Turn Indicator]:

Select this sub-menu to enable/disable the items described below to **ON** or **OFF**.

[3 Flash On]

Select this sub-menu to enable/disable the [3 Flash On] lane change signal feature. See, "Turn signal switch" in the "2. Instruments and controls" section.

[Unlocking] (where fitted):

Select this sub-menu to enable/disable the items described below to **ON** or **OFF**.

[I-Key Door Lock]

Select this item to activate/deactivate the request switch on the door. See, "Doors" in the "3. Pre-driving checks and adjustments" section.

[Wipers]:

Select this sub-menu to enable/disable the items described below to **ON** or **OFF**.

[Speed Dependent]

Select this item to activate/deactivate the speed dependent wiper speed feature. See, "Wiper and washer switch" in the "2. Instruments and controls" section.

[Maintenance]

The following sub-menus are available under the [Maintenance] menu.

[Service]

[Filter]

[Tyre]

[Other]

[Service] (where fitted):

Select this item to show the remaining distance until servicing is required.

To reset the service indicator, push <ENTER> and select [Yes].

The distance to service interval cannot be adjusted manually. The interval is set automatically.

NOTE

Be sure the distance to service indicator is reset after servicing. Otherwise, the service indicator will continue to be displayed.

[Filter] (where fitted):

Select this item to set or reset the distance for replacing the oil filter.

The distance can be set from [— —] (off) to 30.000 km in 500 km increments.

[Tyre]:

Select this item to set or reset the distance for replacing the tyres.

The distance can be set from [— —] (off) to 30.000 km in 500 km increments.

[Other]:

Select this item to set or reset a reminder for replacing something other than service, the oil filter, or tyres.

The distance can be set from [— —] (off) to 30.000 km in 500 km increments.

[Alert]

The following items are available under the [Alert] menu.

[Timer]

[Navigation] (where fitted)

[Phone] (where fitted)

[Mail] (where fitted)

[Timer]:

Select this sub-menu to specify when the [Time for a driver break?] message activates.

The time can be set from [— —] (off) to 6 hours in increments of 30 minutes.

[Navigation] (where fitted):

Select this item to enable/disable the navigation system information in the vehicle information display.

[Phone] (where fitted):

Select this item to enable/disable incoming call information in the vehicle information display.

[Mail] (where fitted):

Select this item to enable/disable incoming mail information in the vehicle information display.

[Units]

The following items are available under the [Units] menu.

[Distance/Fuel]

[Temperature]

[Distance/Fuel]:

The unit for the distance and fuel consumption that displays in the vehicle information display can be changed to:

[km, l/100km]

[km, km/l]

[miles, MPG]

[Temperature]:

The temperature that displays in the vehicle information display can be changed from:

°C (Celsius)

°F (Fahrenheit)

[Language]

The language of the vehicle information display can be changed to:

English

French

German

Italian

Portuguese

Dutch

Spanish

Turkish

Russian

Use the ▲ or ▼ and the <ENTER> buttons to select and change the language of the vehicle information display.

[Factory Reset]

The settings in the vehicle information display can be reset back to the factory default. To reset the vehicle information display:

1. Use the ▲ or ▼ buttons to select [Settings], and press the <ENTER> button.
2. Select [Factory Reset] using the ▲ or ▼ buttons and press the <ENTER> button.
3. Select [Yes] to return all settings back to default by pressing the <ENTER> button.

3. Select [Yes] to return all settings back to default by pressing the <ENTER> button.

To cancel the reset operation select [No] or press the BACK button located on the left side of the steering wheel.

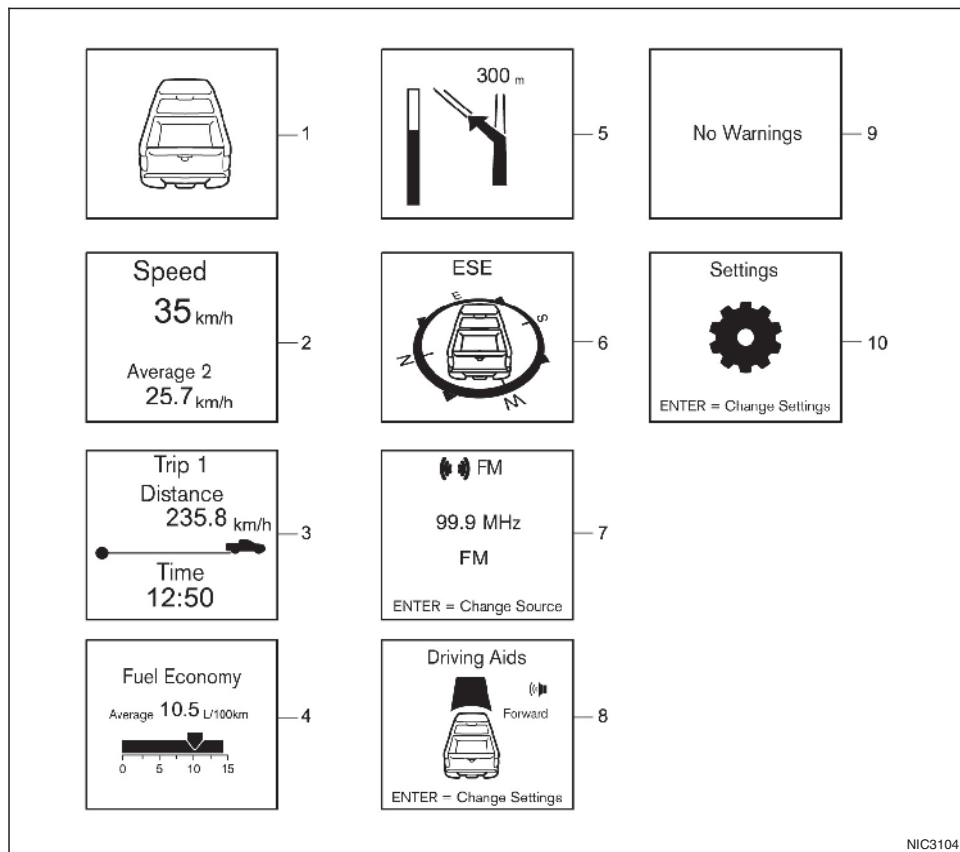

TRIP COMPUTER

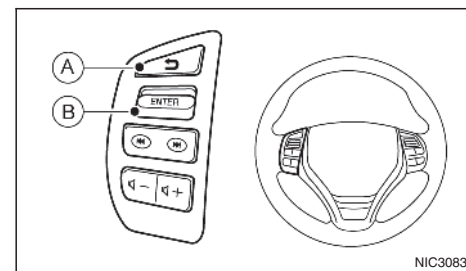

Type A

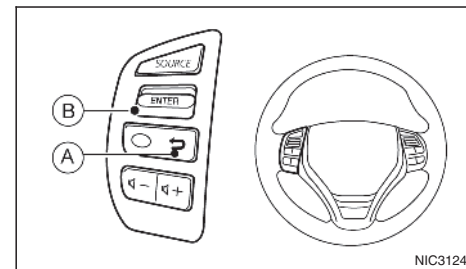

Type B

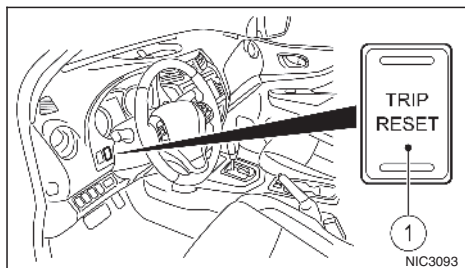

Left Hand Drive (LHD) model

Switches for the trip computer (where fitted) are located on the instrument panel on either the left or right side of the steering column ①. To operate the trip computer, push the switches as shown above.

Each time the ▲ or ▼ switch ② is pushed, the display will change as follows:

Car view (Home) → Average speed → Elapsed time and trip odometer → Current and average fuel consumption → Navigation (where fitted) → Compass (where fitted) → Audio (where fitted) → Driving aids (where fitted) → Warning check → Settings → Car view (Home)

When the <ENTER> switch ③ is pushed and held for more than 3 seconds, the average speed, the elapsed time, the trip odometer, the current and average fuel consumption can be reset.

1. Car view [Home]

The Car view [Home] screen can be selected when the driver does not want see any information on the trip computer screen.

2. [Speed] and [Average]

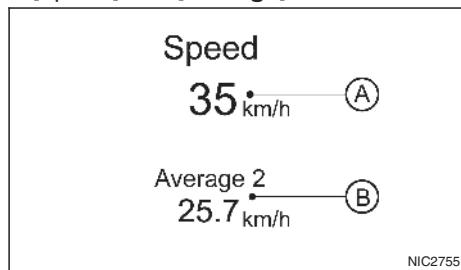

The (digital) speed ① shows the current speed at which the vehicle is travelling.

The average speed ② shows the average vehicle speed since the last reset. Shortly press the <ENTER> switch to switch between trip 1 and 2. Pressing the <ENTER> switch for longer than 1 second enters the Reset menu.

The display is updated every 30 seconds. The first 30 seconds after a reset, the display shows [—].

3. [Trip]

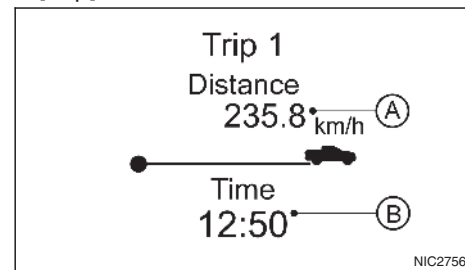

Trip [Distance] ①:

The trip odometer mode shows the total distance the vehicle has been driven since the last reset. Shortly press the <ENTER> switch to switch between trip 1 and 2. Pressing the <ENTER> switch for longer than 1 second enters the Reset menu. (The elapsed time is also reset at the same time.)

Elapsed [Time] ②:

The elapsed time mode shows the time since the last reset. Shortly press the <ENTER> switch to switch between trip 1 and 2. Pressing the <ENTER> switch for longer than 1 second enters the Reset menu. (The trip odometer is also reset at the same time.)

4. [Fuel Economy]

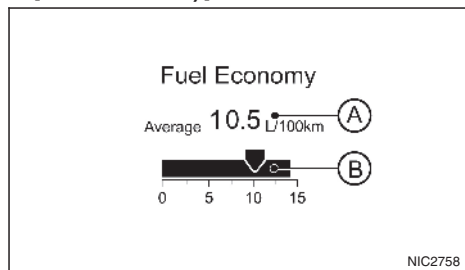

[Average] fuel consumption (A):

The average fuel consumption mode shows the average fuel consumption since the last reset. Push the <ENTER> switch for longer than 1 second to enter the Reset menu.

The display is updated every 30 seconds. For about the first 500 m (1/3 mile) after a reset, the display shows [—].

Push <ENTER> briefly to show the second Fuel Economy page.

The unit of measurement (l/100km, km/l, or MPG) can be set in the settings menu. See, "[Units]" in the "2. Instruments and controls" section.

Current fuel consumption (B):

The scale shows the current fuel consumption.

5. [Navigation] (where fitted)

When the route guidance is set in the navigation system, this item shows the navigation route information.

6. Compass (where fitted)

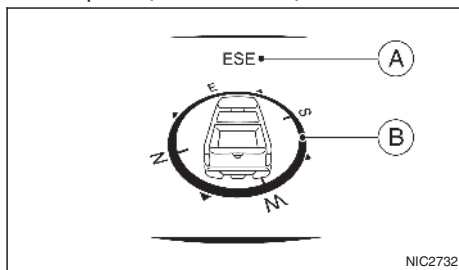

This display indicates the heading direction of the vehicle (A) as well as a compass rose (B) around the vehicle representation.

7. [Audio] (where fitted)

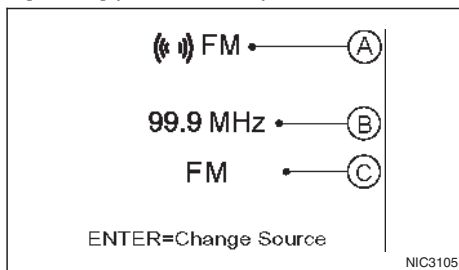

- (A) Current source
- (B) Current frequency
- (C) Current radio station name

The audio mode shows the status of audio information.

For more details, see "FM AM radio with compact disc (CD) player (Type A)" in the "4. Display screen, heater and air conditioner, and audio system" section or the separately provided Touchscreen Navigation Owner's manual.

8. [Driving Aids] (where fitted)

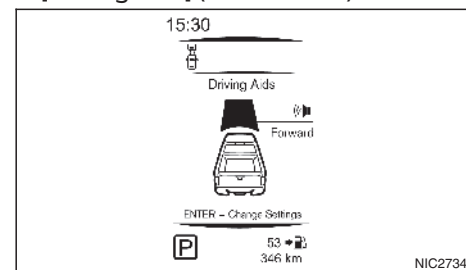

The driving aids mode shows the operating condition for the driving aids.

Active Emergency Braking

Push <ENTER> to access the [Driving Aids] setting menu.

For more details, see "Active Emergency Braking system (where fitted)" in the "5. Starting and driving" section.

9. Warnings

The present warnings are displayed. If no warnings are present, [No Warnings] is displayed.

10. [Settings]

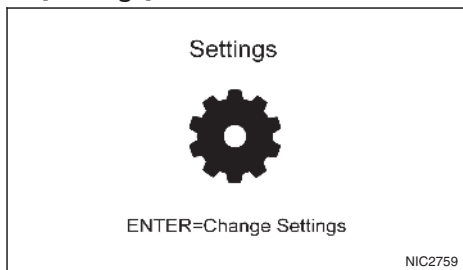

Push <ENTER> to access the settings menu.

For more details, see "Settings" earlier in this section.

Distance to empty (dte – km or mile)

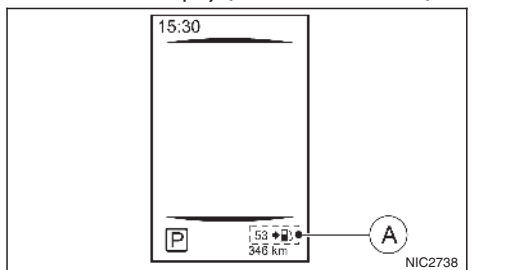

The distance to empty (dte) feature (A) provides you with an estimation of the distance that can be driven before refuelling. The dte is constantly being calculated based on the amount of fuel in the fuel tank and the actual fuel consumption.

The display is updated every 30 seconds.

The dte feature includes a low range warning feature. If the fuel level is low, a warning is displayed on the screen.

When the fuel level drops even lower, the dte display will change to [----].

If the amount of fuel added is small, the display just before the ignition switch is placed in the **OFF** position may continue to be displayed.

When driving uphill or rounding curves, the fuel in the tank shifts, which may momentarily change the display.

INDICATORS FOR OPERATION

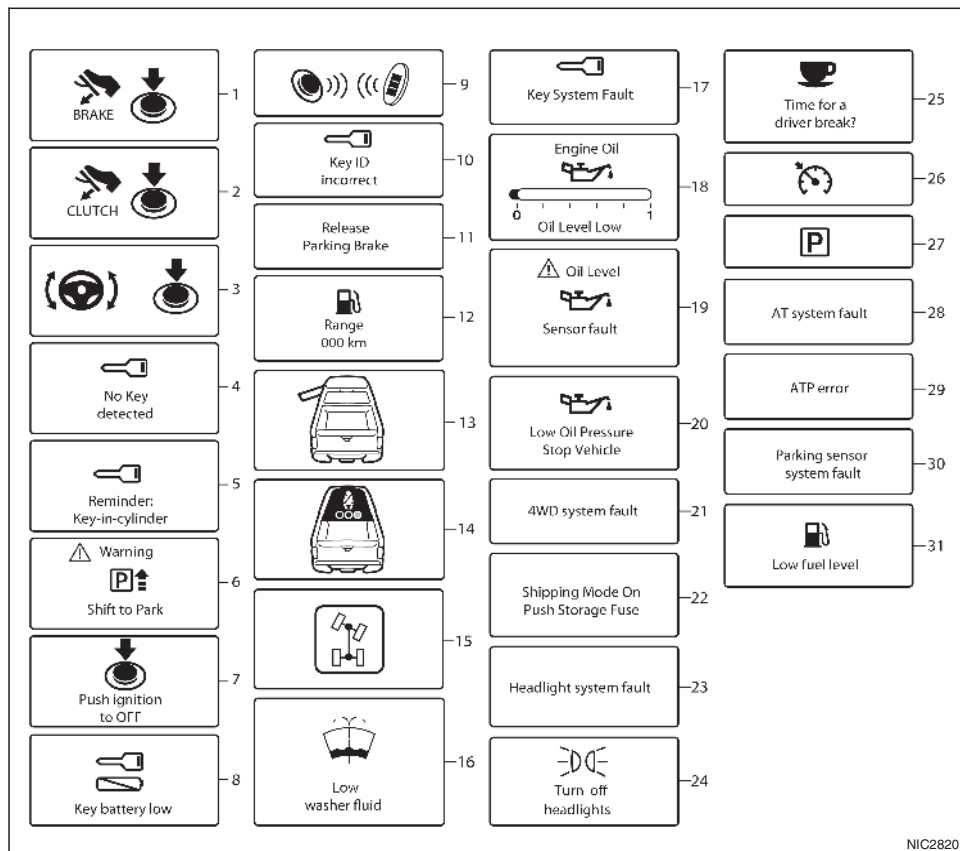

NIC2820

1. Engine start operation indicator (where fitted for Automatic Transmission (AT) models)

This indicator appears when the shift lever is in the P (Park) position.

This indicator means that the engine will start by pushing the ignition switch with the brake pedal depressed. You can start the engine directly in any position of the ignition switch.

2. Engine start operation indicator (where fitted for Manual Transmission (MT) models)

This indicator means that the engine will start by pushing the ignition switch with the clutch pedal depressed. You can start the engine directly in any position of the ignition switch.

You can also start the engine by pushing the ignition switch with the brake pedal depressed when the shift lever is in the N (Neutral) position.

3. Steering lock release malfunction indicator (where fitted)

This indicator appears when the steering wheel cannot be released from the **LOCK** position.

If this indicator appears, turn or push the ignition switch while lightly turning the steering wheel right and left.

See "Remote Control Key battery discharge" in the "5. Starting and driving" section "Remote controller battery replacement" in the "5. Maintenance and do-it-yourself" section.

4. No Key Detected warning (where fitted)

This warning appears when the door is closed with the Remote Control Key left outside the vehicle and the ignition switch in the **ON** position. Make sure that the Remote Control Key is inside the vehicle.

See "Remote Control Key system (where fitted)" in the "3. Pre-driving checks and adjustments" section for more details.

5. Key reminder warning (where fitted)

This warning appears if the driver's side door is opened while the key is left in the ignition switch and ignition switch is in the **ACC**, **OFF** or **LOCK** position. Remove the key and take it with you when leaving the vehicle.

6. Shift to Park warning (where fitted for AT models)

This warning appears when the ignition switch is pushed to stop the engine with the shift lever in any position except the P (Park) position.

If this warning appears, move the shift lever to the P (Park) position or push the ignition switch to the **ON** position.

An inside warning chime will also sound. (See "Shifting" in the "5. Starting and driving" section.)

7. Push ignition to OFF warning (where fitted for AT models)

This warning appears when the shift lever is moved to the P (Park) position with the ignition switch in the **ACC** position after the Shift to Park warning appears.

To push the ignition switch to the **OFF** position, perform the following procedure:

Shift to Park warning → (Move the shift lever to P) → **PUSH warning** → (Push the ignition switch → ignition switch position is turned to **ON**) → **PUSH warning** → (Push the ignition switch → ignition switch position is turned to **OFF**)

8. Key Battery low warning (where fitted)

This warning appears when the Remote Control Key battery is running out of power.

If this warning appears, replace the battery with a new one. (See "Remote Control Key battery replacement" in the "8. Maintenance and do-it-yourself" section.)

9. Engine start operation for Remote Control Key system indicator (where fitted)

This indicator appears when the Remote Control Key battery is running out of power and when the Remote Control Key system and vehicle are not communicating normally.

If this indicator appears, touch the ignition switch with the Remote Control Key while depressing the brake pedal. (See "Remote Control Key battery discharge" in the "5. Starting and driving" section.)

10. Key ID Incorrect warning (where fitted)

This warning appears when the ignition switch is changed from the **LOCK** position and the Remote Control Key cannot be recognised by the system.

You cannot start the engine with an unregistered key. Use the registered Remote Control Key.

See "Remote Control Key system (where fitted)" in the "3. Pre-driving checks and adjustments" section.

11. Release Parking Brake warning

This warning appears when the vehicle speed is above 7 km/h (4 MPH) and the parking brake is applied. Stop the vehicle and release the parking brake.

12. Low fuel warning

This warning appears when the fuel level in the tank is getting low. Refuel as soon as it is convenient, preferably before the fuel gauge reaches the empty (0) position.

There will be a small reserve of fuel remaining in the tank when the fuel gauge reaches the empty (0) position.

13. Door open warning

This warning appears if any of the doors are open or not closed securely. The vehicle icon indicates which door is open on the display. Make sure that all of the doors are closed.

14. Second row seat belt warning (where fitted)

This second row seat belt warning appears after the ignition switch is placed in the ON position. If any of the second row seat passenger seat belts is not fastened, a chime will sound and the seat icon illuminates in red to show which seat belt is not fastened. The seat icon illuminates in red until the corresponding second row seat passenger's seat belt is fastened. The warning will automatically turn off after approximately 35 seconds.

For more details and precautions on seat belt usage, see "Seat belts" in the "1. Safety – seats, seat belts and supplemental restraint system" section.

15. 4WD mode indicator (where fitted)

This indicator shows the drive mode of the 4WD system.

See "Four-Wheel Drive (4WD) (where fitted)" in the "5. Starting and driving" section for details.

16. Low washer fluid warning (where fitted)

This warning appears when the washer tank fluid is at a low level. Add washer fluid as necessary. (See "Window washer fluid" in the "8. Maintenance and do-it-yourself" section.)

17. Key System Error warning (where fitted)

This warning appears if there is a malfunction in the Remote Control Key system.

If this warning appears while the engine is stopped, the engine cannot be started. If this warning appears while the engine is running, the vehicle can be driven. However, contact an approved dealer or qualified workshop for repair as soon as possible.

18. Oil Level Low indicator (where fitted)

If the low level indicator is displayed, the engine oil level is low. If the low level indicator is displayed, check the level using the engine oil dipstick. (See "Checking engine oil level" in the "8. Maintenance and do-it-yourself" section.)

CAUTION

The oil level should be checked regularly using the engine oil dipstick. Operating with an insufficient amount of oil can damage the engine and such damage is not covered by the warranty.

19. Oil level sensor warning (where fitted)

If the oil level sensor warning is displayed, the engine oil level sensor may be malfunctioning. Contact an approved dealer or qualified workshop immediately.

20. Low Oil Pressure Stop vehicle warning (where fitted)

This warning appears if low engine oil pressure is detected. If the warning appears during normal driving, pull off the road in a safe area, stop the engine immediately and call an approved dealer or qualified workshop.

The low oil pressure warning is not designed to indicate a low oil level. Use the dipstick to check the oil level. (See "Checking engine oil level" in the "8. Maintenance and do-it-yourself" section.)

CAUTION

Running the engine with the engine oil pressure warning displayed could cause serious damage to the engine.

21. 4WD Error warning (where fitted)

This warning appears when the four wheel drive (4WD) system is not functioning properly while the engine is running. Reduce vehicle speed and have your vehicle checked by an approved dealer or

qualified workshop. See "Four-Wheel Drive (4WD) (where fitted)" in the "5. Starting and driving" section.

22. Shipping Mode On Push Storage Fuse warning (where fitted)

This warning may appear if the extended storage fuse switch is not pushed in (switched on). When this warning appears, push in (switch on) the extended storage fuse switch to turn off the warning. For more information, see "Fuses" in the "8. Maintenance and do-it-yourself" section.

23. Headlight System Error warning (where fitted)

This warning appears if the LED headlights are malfunctioning. Have the system checked by an approved dealer or qualified workshop.

24. Reminder Turn OFF Headlights warning

This warning appears when the driver side door is opened with the headlight switch is left **ON** and the ignition switch is placed in the **OFF, ACC** or **LOCK** position. Place the headlight switch in the <OFF> or <AUTO> (where fitted) position. For additional information, see "Headlight and turn signal switch" in the "2. Instruments and controls" section.

25. Time for a driver break? indicator

This indicator appears when the set [Timer] alarm activates. You can set the time for up to 6 hours. (See "Settings" earlier in this section.)

26. Cruise control indicator (where fitted)

This indicator shows the cruise control system status. The status is shown by the colour.

See "Cruise control (where fitted)" in the "5. Starting and driving" section for details.

27. Automatic Transmission (AT) position indicator (AT models)

This indicator shows the automatic shift position.

In the manual shift mode, when the transmission does not shift to the selected gear due to a transmission protection mode, the AT position indicator will blink and a chime will sound.

For further details, see "Driving with Automatic Transmission (AT)" in the "5. Starting and driving" section.

28. Automatic Transmission (AT) Error warning (AT models)

If the Automatic Transmission (AT) Error warning appears while the engine is running, or while driving, it may indicate that the AT is not functioning properly and may need servicing. Have the system checked, and if necessary repaired, by an approved dealer or qualified workshop promptly.

29. Automatic Transmission (AT) park warning (AT models)

This warning indicates that the Automatic Transmission (AT) parking function is not engaged. If the transfer control is not secured in any driving position while the AT shift lever is in the P (Park) position, the transmission will disengage and the wheels will not lock.

For 4WD model: If the ATP warning appears with the shift lever in the P (Park) position, shift the Four-Wheel Drive (4WD) mode switch to the <2WD>, <4H> or <4LO> position again with the shift lever in the N (Neutral) position. (See "Four-Wheel Drive (4WD) (where fitted)" in the "5. Starting and driving" section.)



WARNING

If the 4WD mode indicator (see "4WD mode indicator" in the "5. Starting and driving" section) is OFF or the ATP warning light is ON, this indicates that the automatic transmission P (Park) position will not function and could result in the vehicle moving unexpectedly, causing serious personal injury or property damage. Always set the parking brake.

30. Parking Sensor Error warning (where fitted)

This warning appears when the parking sensor (sonar) system is not functioning properly. If the warning appears, have the system checked by an approved dealer or qualified workshop.

31. Low fuel level warning

The low fuel level warning appears on the vehicle information display when the fuel level in the tank is getting low. Refuel as soon as it is convenient, preferably before the gauge reads the empty position. For further details, see "Fuel gauge" earlier in this section.

OIL CONTROL SYSTEM (where fitted)

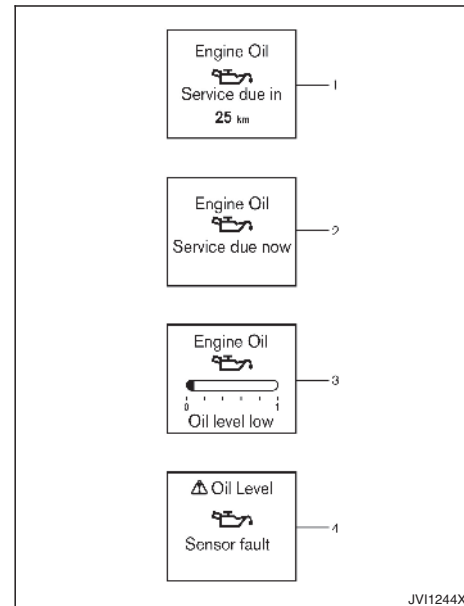

When the ignition switch is in the **ON** position, engine oil information is displayed.

Engine oil information informs the distance to oil change, oil level indication and malfunction of oil level sensor.

1. Distance to oil change

The distance to oil change is displayed if the distance to oil change is less than 1,500 km (930 miles).

2. Oil replacement indicator

When the set mileage approaches, the engine oil replacement indicator will appear on the display. After the oil is changed, reset the distance to oil change. The oil replacement indicator will not be reset automatically. To reset this indicator, see "Settings" earlier in this section.

The distance to oil change interval cannot be adjusted manually. The distance to oil change interval is set automatically.

CAUTION

If the oil replacement indicator is displayed, change the engine oil as soon as possible. Operating your vehicle with deteriorated oil can damage the engine.

Never perform reset if the engine oil was not changed. Always visit an approved dealer or qualified workshop to perform the engine oil change including an oil filter change and the reset.

NOTE

It is not possible to undo the reset.

Resetting the oil change distance is only possible when:

- The distance to oil change is displayed in the vehicle information display.
- The oil replacement indicator is displayed in the vehicle information display.

The engine oil should be changed before the distance to oil change reaches 0 km (0 miles). Continued driving after the distance to oil change reaches 0 km (0 miles) may result in reduced engine performance.

The Diesel Particulate Filter (DPF) may also become saturated because regeneration is restricted once the distance to oil change reaches 0 km (0 miles).

Have the vehicle inspected by an approved dealer or qualified workshop if the above condition occurs.

The oil change interval will reduce faster with certain types of driving, especially at low speeds in urban conditions.

3. Low level reminder

If the low level indicator is displayed, the engine oil level is low. If the low level reminder is displayed, check the level using the engine oil dipstick. (See "Checking engine oil level" in the "8. Maintenance and do-it-yourself" section.)

CAUTION

The oil level should be checked regularly using the engine oil dipstick. Operating with an insufficient amount of oil can damage the engine and such damage is not covered by the warranty.

4. Oil level sensor warning

If the oil sensor warning is displayed, the engine oil level sensor may be malfunctioning. Contact an approved dealer or qualified workshop immediately.

CLOCK AND OUTSIDE AIR TEMPERATURE (where fitted)

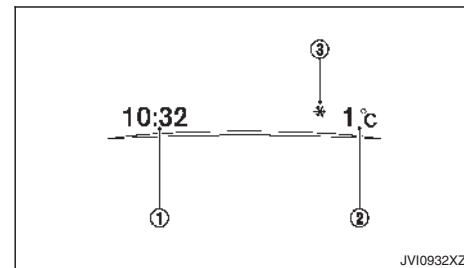

The clock ① and outside air temperature ② are displayed on the upper side of the vehicle information display.

[Clock]

For details of how to set the clock, see "Settings" earlier in this section or the separately provided Touchscreen Navigation Owner's manual.

[Outside Temp.] (°C or °F)

The outside air temperature is displayed in °C or °F in the range of -40 to 60°C (-40 to 140°F).

The outside air temperature mode includes a low temperature warning feature. If the outside air temperature is below 3°C (37°F), the warning ③ is displayed on the screen (where fitted).

HEADLIGHT AND TURN SIGNAL SWITCH

The outside temperature sensor is located in front of the radiator. The sensor may be affected by road or engine heat, wind directions and other driving conditions. The display may differ from the actual outside temperature or the temperature displayed on various signs or billboards.

HEADLIGHT SWITCH

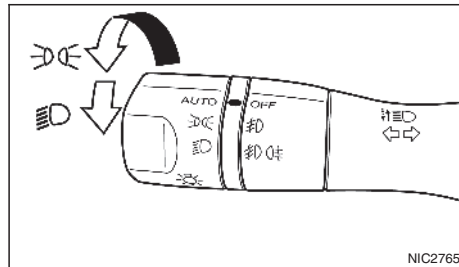

RENAULT recommends that you consult the local regulations concerning the use of lights.

AUTO position

When the ignition switch is in the **ON** position and the headlight switch is in the <AUTO> position, the headlights, front clearance lights, instrument panel lights, rear combination lights and other lights turn on automatically depending on the brightness of the surroundings.

The headlights will turn on automatically at twilight or in rainy weather (when the windscreen wiper is operated continuously).

When the ignition switch is placed in the **OFF** position, the lights will turn off automatically.

CAUTION

Do not place any objects on top of the brightness sensor. The sensor senses the brightness level and controls the autolight function. If the sensor is covered, it reacts as if it is dark, and the headlights will illuminate.

position

The position turns on the front clearance, instrument panel, tail and number plate lights.

position

The position turns on the headlights in addition to the other lights.

Headlight beam

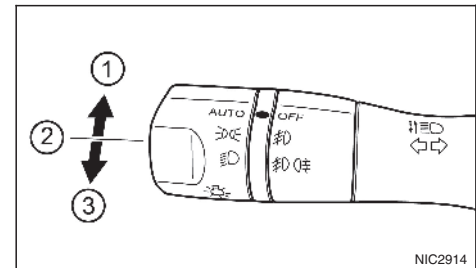

To turn on the high beam, push the lever towards the front position ①.

To turn off the high beam, return the lever to the neutral position ②.

To flash the headlights, pull the lever towards the rearmost position ③. The headlights can be flashed even when the headlights are not on.

Friendly lighting (where fitted):



When the lever is pulled towards the rearmost position ③ after the ignition switch is placed in the **OFF** or **LOCK** position, the headlights will turn on and

stay on for 30 seconds. Each time the lever is pulled towards the rearmost position 30 seconds are added to the timer.

The lever can be pulled up to 4 times for 2 minutes of illumination.

Daytime running light system (where fitted)

Even if the headlight switch is in the **OFF** position, the daytime running lights will come on after starting the engine.

When the light switch is turned to the  or  position, the daytime running light will turn off.

HEADLIGHT AIMING CONTROL (where fitted)

Manual type

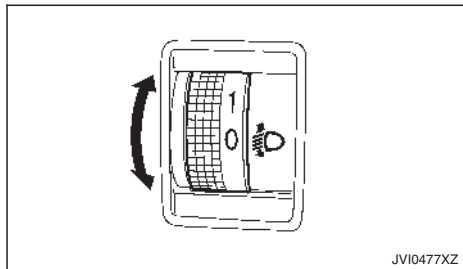

The headlight aiming control operates when the ignition switch is in the **ON** and the headlight switch is in the  position to allow the headlight axis to be adjusted according to the driving condition.

When driving with no heavy load/luggage or driving on a flat road, select the normal position <0>.

If the number of occupants and load/luggage in the vehicle changes, the headlight axis may become higher than normal.



If the vehicle is travelling on a hilly road, the headlights may directly shine on the rearview and outside mirrors of a vehicle ahead or the windscreen of an oncoming vehicle, which may obscure another drivers' vision.



To adjust to the proper aiming height, turn the switch accordingly. The higher the number, designated on the switch, the lower the headlight axis.

Automatic type

For vehicles fitted with an automatic levelling system, the headlight axis is controlled automatically.

BATTERY SAVER SYSTEM (where fitted)

The light reminder chime will sound if the headlight switch is in either the  or  position and when the driver's door is opened with the ignition switch in the **ACC**, **OFF** or **LOCK** position.

If the ignition switch is placed in the **OFF** or **LOCK** position while the headlight switch is in the  or  position, the battery saver function will turn off the lights after a period of time to prevent the battery from being discharged.

CAUTION

Do not leave the lights on when the engine is not running for extended periods of time to prevent the battery from being discharged.

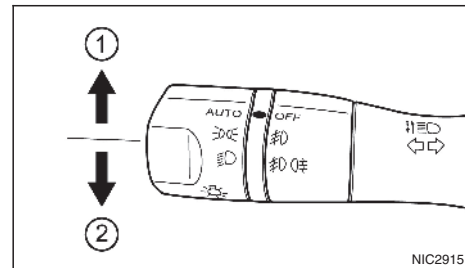

TURN SIGNAL SWITCH





CAUTION

The turn signal switch will not be cancelled automatically if the steering wheel turning angle does not exceed the preset amount. After the turn or lane change, make sure that the turn signal switch is returned to its original position.

Turn signal

To turn on the turn signals, move the lever up  or down  to the point where the lever latches. When the turn is completed, the turn signal cancels automatically.

Lane change signal

To turn on the lane change signals, move the lever up  or down  to the point where the light begins to flash.

If the lever is moved back to its original position right after moving up or down, the light will flash 3 times.

FOG LIGHT SWITCH (where fitted)



To cancel the flashing, move the lever to the opposite direction.

See “Settings” earlier in this section to enable/disable the lane change signal.

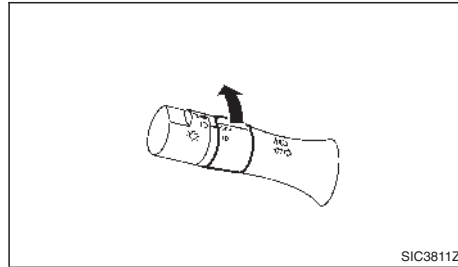
FRONT FOG LIGHTS (where fitted)



The front fog lights should only be used when visibility is seriously reduced – generally, to less than 100 m (328 ft).

To turn the front fog lights on, turn the headlight switch to the <AUTO>,  or  position and turn the fog light switch to the  position. The front fog lights and indicator light will come on. For additional information, see “Warning lights, indicator lights and audible reminders” earlier in this section.





To turn the front fog lights off, turn the fog light switch to the <AUTO> position. The front fog lights and indicator light will turn off.



NOTE

If the headlight switch is turned to the <AUTO> position (and the front fog lights are turned on), the front fog lights will switch on/off automatically together with the headlights.

REAR FOG LIGHT (where fitted)

The rear fog light should only be used when visibility is seriously reduced – generally, to less than 100 m (328 ft).

To turn the rear fog light on, turn the headlight switch to the  or  position and turn the fog light switch to the  position. The rear fog light and indicator light will come on. The fog light switch will return to the  position. For additional information, see “Warning lights, indicator lights and audible reminders” earlier in this section.

If the front fog lights (where fitted) are already turned on with the headlight switch in the  position, you can turn on the rear fog light without first turning the headlight switch to the  or <AUTO> position.

To turn the rear fog light off, turn the fog light switch to the  position again.

NOTE

If the headlight switch is turned to the <AUTO> position, the rear fog light will switch off automatically.

WIPER AND WASHER SWITCH



WARNING

In freezing temperatures, the washer fluid may freeze on the windscreen and obscure your vision. Warm the windscreen with the defogger before you wash the windscreen.

CAUTION

Do not operate the washer continuously for longer than 30 seconds.

Do not operate the washer if the window washer fluid reservoir is empty.

If the wiper operation is interrupted by snow or ice, the wiper may stop moving to protect its motor. If this occurs, turn the wiper switch to the OFF position and remove the snow or ice on and around the wiper arms. In approximately 1 minute, turn the switch on again to operate the wiper.

WINDSCREEN WIPER AND WASHER SWITCH

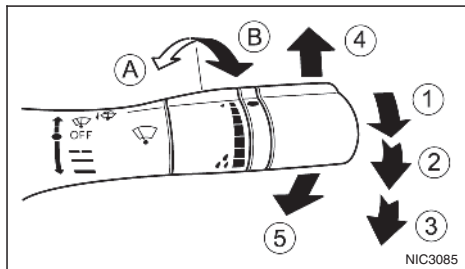

The windscreen wiper and washer operate when the ignition switch is in the **ON** position.

Wiper operation

The lever position ① operates the wiper intermittently.

The intermittent operation can be adjusted by turning the adjustment control knob, (shorter) (A) or (longer) (B).

The lever position ② operates the wiper at low speed.

The lever position > ③ operates the wiper at high speed.

To stop the wiper operation, move the lever up to the <OFF> position.

Push the lever up ④ for a single sweep of the wiper. The lever automatically returns to its original position.

Washer operation

Pull the lever towards you ⑤ to operate the washer. For every fifth operation of the wiper and washer, the headlight washing system (where fitted) will be activated to clean the headlights. The headlight washing system is only activated while the headlight switch is in the  position. See "Headlight cleaner (where fitted)" later in this section.

DEFOGGER SWITCH (where fitted)

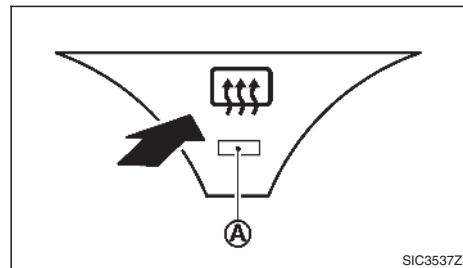

Type A

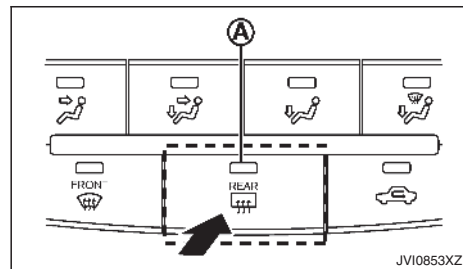

Type B

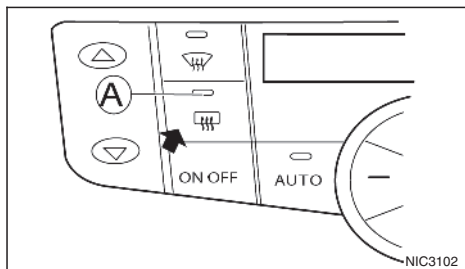

Type C - LHD

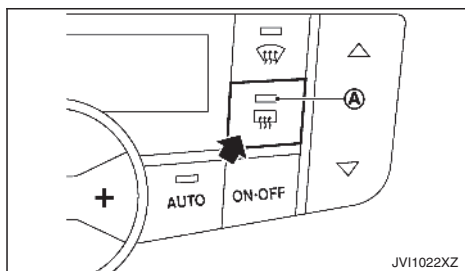

Type C - RHD

The rear window defogger switch operates when the ignition switch is in the **ON** position.

The defogger is used to reduce the moisture, fog or frost on the rear window and outside rearview mirror (where fitted) surfaces to improve the rear view.

When the defogger switch is pushed, the indicator light (A) illuminates and the rear window defogger operates for approximately 15 minutes. After the preset time has passed, the defogger will turn off automatically.

To turn the rear window defogger off manually, push the defogger switch again.

CAUTION

When operating the defogger continuously, be sure to start the engine. Otherwise, it may cause the battery to discharge.

When cleaning the inner side of the window, be careful not to scratch or damage the electrical conductors on the surface of the window.

HEADLIGHT CLEANER (where fitted)

To clean the headlights, pull the windscreen washer switch towards you while the headlight switch is in the  position and the ignition switch is in the **ON** position.

NOTE

The headlight cleaner will automatically operate every fifth operation of the wiper and washer switch.

HEADLIGHT CLEANER SWITCH (where fitted)

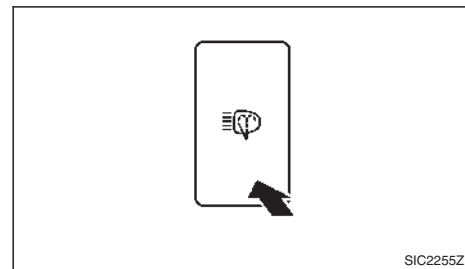

Headlight cleaner switch (where fitted)

The headlight cleaner operates when the headlight and turn signal switch is in the  position and the ignition switch is in the **ON** position.

To operate the headlight cleaner push the headlight cleaner switch located on the driver's side, lower left side of the instrument panel.

HORN

CAUTION

Do not operate the cleaner continuously for more than 15 seconds.

Do not operate the cleaner if the washer fluid reservoir is empty or frozen.

See "Window washer fluid" in the "8. Maintenance and do-it-yourself" section for details on refilling the reservoir tank.

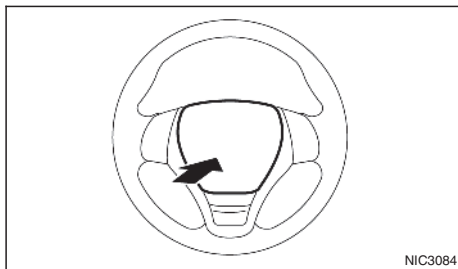

The horn switch operates regardless of the ignition switch position except when the battery is discharged.

When the horn switch is pushed and held, the horn will sound. Releasing the horn switch will cease the horn sound.

WINDOWS

MANUAL WINDOWS (where fitted)

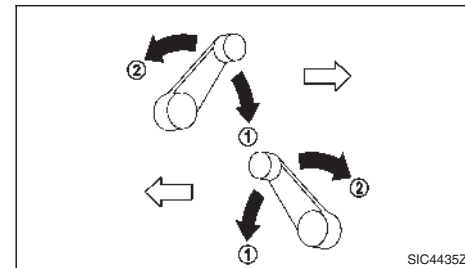

The side windows can be opened ① or closed ② by turning the hand crank on each door.

POWER WINDOWS (where fitted)



WARNING

Make sure that all passengers have their hands, etc. inside the vehicle before operating the power windows.

To help avoid risk of injury or death through unintended operation of the vehicle and/or its systems, do not leave children, people who require the assistance of others, or pets unattended in your vehicle. Additionally, the temperature inside a closed vehicle on a warm day can quickly become high enough to cause a significant risk of injury or death to people and pets.

The power windows operate when the ignition switch is in the "ON" position.

To open a window, push down the power window switch.

To close a window, pull up the power window switch.

Driver's main window switch

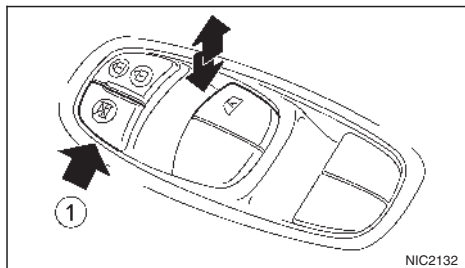

The driver's switch, which is the main switch, can control all of the windows.

Locking passenger's windows:

When the lock button ① is pushed in, the passenger's windows cannot be operated.

To cancel the passenger's windows lock, push the lock button ① again.

Passenger's window switch

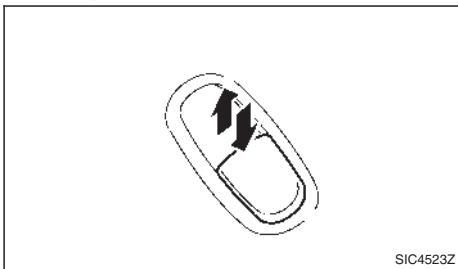

The passenger's switch can control its corresponding window.

When the passenger's windows lock button on the driver's switch is pushed in, the passenger's switch cannot be operated.

Automatic function

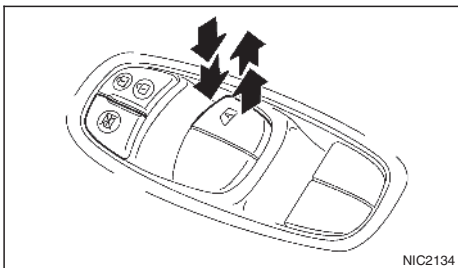

The automatic function is available for the switch that has an **A** mark on its surface.

The automatic function enables a window to fully open or close without holding the switch down or up.

To fully open the window, push the power window switch down to the second detent and release the switch. To fully close the window, pull the power window switch up to the second detent and release the switch. The switch does not have to be held during window operation.

To stop the window open/close operation during the automatic function, push down or pull up the switch in opposite directions.

Auto-reverse function:



WARNING

There is a small distance just before the closed position which cannot be detected. Make sure that all passengers have their hands, etc. inside the vehicle before closing the windows.

The auto-reverse function enables a window to automatically reverse when something is caught in the window as it is closing by the automatic function. When the control unit detects an obstacle, the window will be lowered immediately.

Depending on the environment or driving conditions, the auto-reverse function may activate if an impact or load similar to something being caught in the window occurs.

POWER OUTLETS

If the window does not close automatically

If the power window automatic function (closing only) does not operate properly, perform the following procedure to initialise the power window system.

1. With the engine running.
2. Close the door.
3. Open the window completely by operating the power window switch.
4. Pull the power window switch and hold it to close the window, and then hold the switch more than 3 seconds after the window is closed completely.
5. Release the power window switch. Operate the window by the automatic function to confirm the initialisation is complete.

If the power window automatic function does not operate properly after performing the procedure above, have your vehicle checked by an approved dealer or qualified workshop.

The power outlet is used to power electrical accessories.

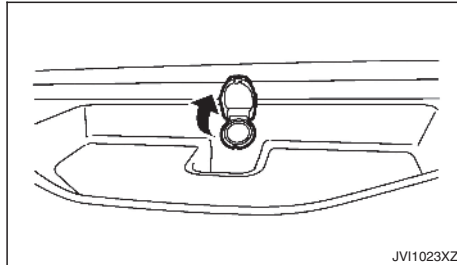

Instrument panel (upper)

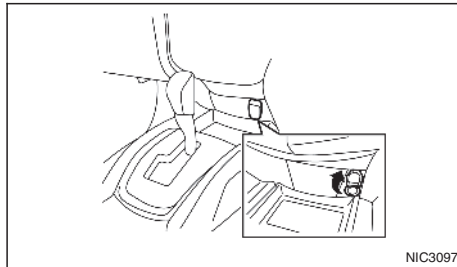

Instrument panel (lower)

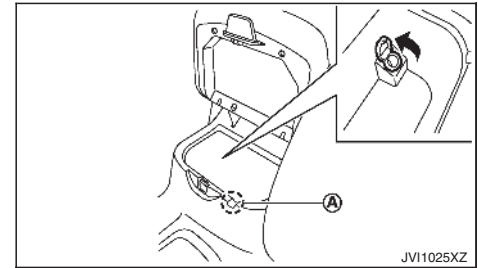

Console box (where fitted)

Use the cutout (A) between the lid and the console box to route a connected power cable with the console box lid closed.



WARNING

Do not place any objects on the instrument panel. Such objects may become dangerous projectiles and cause injury if a supplemental air bag inflates (where fitted).

CAUTION

Do not leave a power cable on the instrument panel in direct sunlight. The surface of the instrument panel may become very hot resulting in damage to the power cable.

Do not put a liquid container near the power outlet. Spilled contents may get into the power outlet and can result in a malfunction.

The outlet and plug may be hot during or immediately after use.

This power outlet is not designed for use with a cigarette lighter unit.

STORAGE

Do not use accessories that exceed a combined power draw of 12 volt, 120W (10A)

Do not use double adapters or more than one electrical accessory.

Use this power outlet with the engine running to avoid discharging the vehicle battery.

Avoid using when the air conditioner, headlights or rear window defogger is on (where fitted).

Push the plug in as far as it will go. If good contact is not made, the plug may overheat or the internal temperature fuse may blow.

Before inserting or disconnecting a plug, be sure that the electrical accessory being used is turned OFF.

When not in use, be sure to close the cap. Do not allow water or any liquid to contact the outlet.



WARNING

The storage compartments should not be used while driving so that the full attention may be given to vehicle operation.

Keep the storage lids closed while driving to help prevent injury in an accident or a sudden stop.

GLOVE BOX

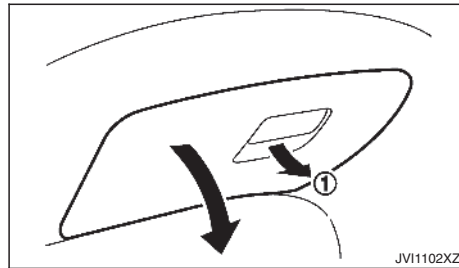

JVI1102XZ

To open the glove box, pull the handle ①.

To close, push the lid in until the lock latches.

CONSOLE BOX

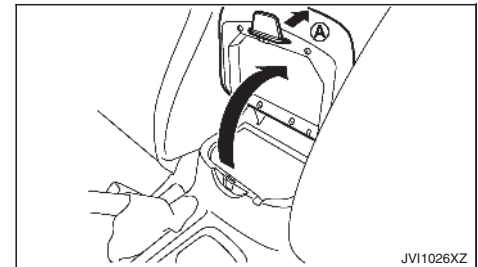

JVI1026XZ

To open the console box lid, push up the knob (A) and pull up the lid.

To close, push the lid down until the lock latches.

SUNGLASSES HOLDER

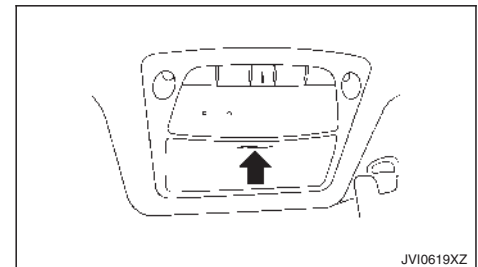

JVI0619XZ



WARNING

Keep the sunglasses holder closed while driving to avoid obstructing the driver's view and to help prevent an accident.

CAUTION

Do not use for anything other than sunglasses.

Do not leave sunglasses in the sunglasses holder while parking in direct sunlight. The heat may damage the sunglasses.

To open the sunglasses holder, push and release. Only store one pair of sunglasses in the holder.

CONSOLE SIDE POCKETS

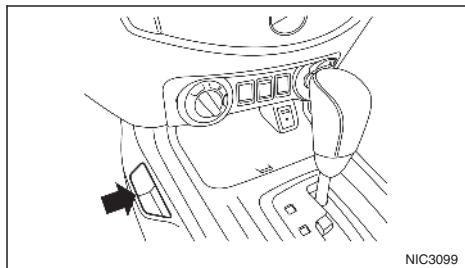

To open the console box lid, push up the knob **A** and pull up the lid.

To close, push the lid down until the lock latches.

CUP HOLDERS (where fitted)



WARNING

The driver must not remove or insert cups into the cup holder while driving so that full attention may be given to vehicle operation.

CAUTION

Avoid abrupt starting and braking especially when the cup holder is being used to prevent spilling the contents. If the contents are hot, they could scald you or your passengers.

Use only soft cups in the cup holder. Hard objects can injure you in an accident.

Centre console (front separate seat models)

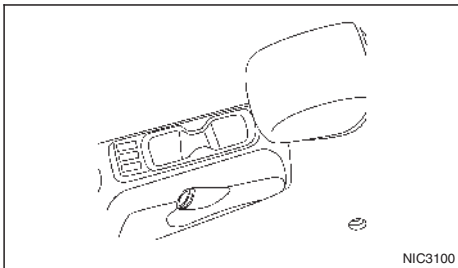

Soft bottle holder

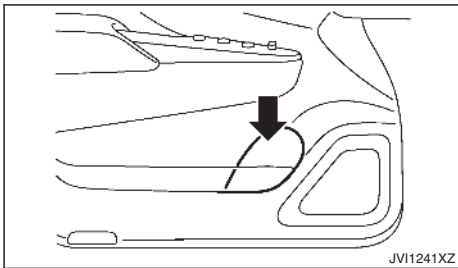

Example

The front and rear (where fitted) soft bottle holders are located on the doors.

CAUTION

Do not use bottle holder for any other objects that could be thrown about in the vehicle and possibly injure people during sudden braking or an accident.

Do not use bottle holder for open liquid containers.

ROOF RAILS (where fitted)

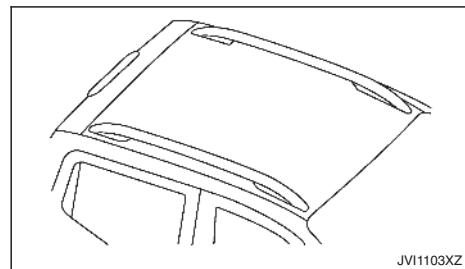

Do not apply any load directly to the roof side rails. Cross bars must be installed before applying load/cargo/luggage to the roof of the vehicle.

The service load capacity for the roof side rails is 100 kg (221 lb) evenly distributed, however do not exceed the accessory cross bars load capacity.

**WARNING**

Always install the cross bars onto the roof side rails before loading cargo of any kind. Loading cargo directly onto the roof side rails or the vehicle's roof may cause vehicle damage.

Drive extra carefully when the vehicle is loaded at or near the cargo carrying capacity, especially if the significant portion of that load is carried on the cross bars.

Heavy loading of the cross bars has the potential to affect the vehicle stability and handling during sudden or unusual handling manoeuvres.

Roof rack cross bar load should be evenly distributed.

Do not exceed maximum roof rail load capacity.

Properly secure all cargo with ropes or straps to help prevent it from sliding or shifting. In a sudden stop or collision, unsecured cargo could cause personal injury.

CAUTION

Use care when placing items on or removing items from the roof rail. If you cannot comfortably lift the items onto or off the roof rail from the ground, use a ladder or stool.

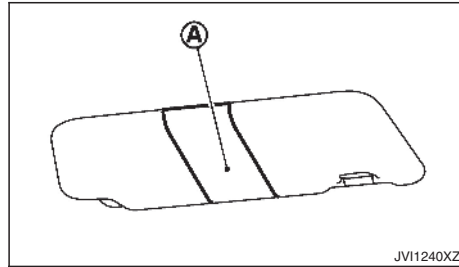
CARD HOLDER (where fitted)

Slide a card in the card holder (A).

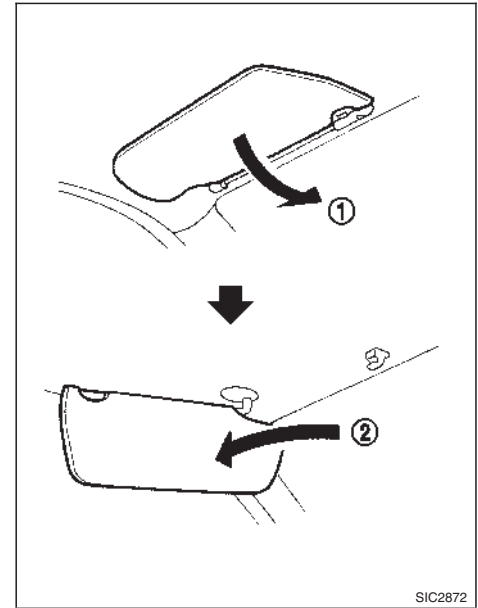

1. To block out glare from the front, swing down the sun visor ①.
2. To block glare from the side, remove the sun visor from the centre mount and swing it to the side ②.

SUNROOF (where fitted)



WARNING

In an accident you could be thrown from the vehicle through an open sunroof. Adults should always use seat belts and children should always use seat belts or child restraint systems.

Never allow anyone to stand up or extend any portion of their body out of the opening while the vehicle is in motion or while the sunroof is closing.

CAUTION

Remove water drops, snow, ice or sand from the sunroof before opening.

Do not place any heavy objects on the sunroof or surrounding area.

AUTOMATIC SUNROOF

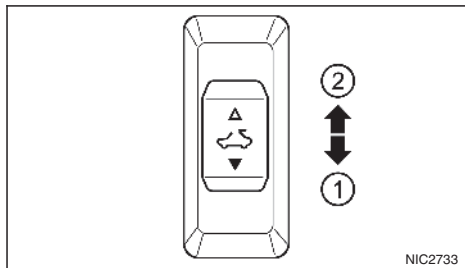

① CLOSE/TILT UP

② OPEN/TILT DOWN

The sunroof operates when the ignition switch is in the **ON** position.

Sunshade

To open or close the sunshade, slide the sunshade manually.

The sunshade will open automatically when the sunroof is opened. The sunshade needs to be closed manually by sliding it.

Sunroof

Sliding:

To fully open or close the sunroof, push the switch to the OPEN ② or CLOSE ① position and release it; it need not be held. The roof will automatically open or close all the way. To stop the roof, push the switch once more while it is opening or closing.

Tilting:

To tilt up, first close the sunroof, then push the switch to the TILT UP position ① and release it; it need not be held. To tilt the sunroof down to the closed position, push the switch to the TILT DOWN position ②.

Auto-reverse function



WARNING

There is a small distance just before the closed position which cannot be detected. Make sure that all passengers have their hands, etc. inside the vehicle before closing the sunroof.

The auto-reverse function enables the sunroof to automatically reverse when something is caught in the sunroof as it is closing. When the control unit detects an obstacle, the sunroof will open immediately.

If the sunroof cannot be closed automatically when the auto reverse function activates due to a malfunction, push and hold the sunroof switch to the CLOSE ① position.

Depending on the environment or driving conditions, the auto-reverse function may activate if an impact or load similar to something being caught in the sunroof occurs.

If sunroof does not operate

If the sunroof does not operate properly, perform the following procedure to initialise the sunroof operation system.

1. If the sunroof is open, close it fully by repeatedly pushing the sunroof switch to the close position ① to tilt the sunroof up.
2. Push and hold the switch to the close position ①.
3. Release the sunroof switch after the sunroof moves slightly up and down.
4. Push and hold the switch to the open position ② to fully tilt the sunroof down.
5. Check if the sunroof switch operates normally.

If the sunroof does not operate properly after performing the procedure above, have your vehicle checked by an approved dealer or qualified workshop.

INTERIOR LIGHTS

CAUTION

Turn off the lights when you leave the vehicle.

Do not use the lights for extended periods of time with the engine stopped. This could result in a discharged battery.

INTERIOR LIGHT SWITCH (where fitted)

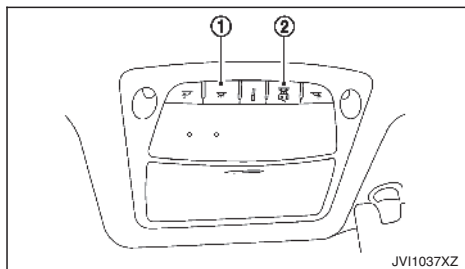

- 1 The interior light can be turned ON regardless of door position. The light will go off after a period of time unless the ignition switch is placed in the ON position when any door is opened.
- 2 The interior lights can be set to operate when the doors are opened. To turn off the interior lights when a door open, push the switch, the interior lights will not illuminate, regardless of door position. The lights will go off when the ignition switch is placed in the ON position, or the driver's door is closed and locked. The lights will also go off after a period of time when the doors are open.

CONSOLE LIGHT (where fitted)

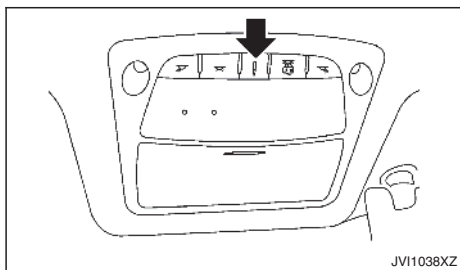

The console light will turn on whenever the clearance lights or headlights are illuminated.

MAP LIGHTS

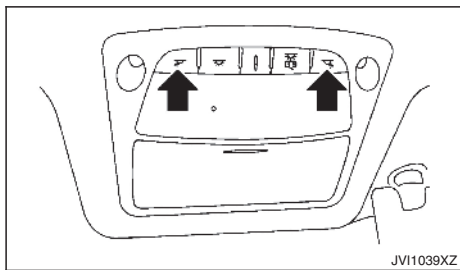

Push the button to turn the map lights on. To turn them off, push the button again.

MAP LIGHT CONTROL SWITCH (where fitted)

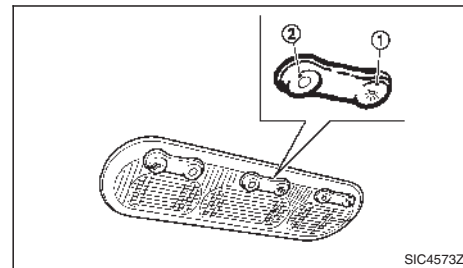

The map lights control switch has three positions: ON ①, OFF ② and centre.

ON position

When the switch is in the ON position ①, the map lights will illuminate.

OFF position

When the switch is in the OFF position ②, the map lights will not illuminate, regardless of any other condition.

Centre position

When the switch is in the centre position, the map lights will illuminate under the following conditions:

- the key is removed from the ignition switch
- remain on for a period of time.

doors are unlocked by pushing the UNLOCK  button (model with remote keyless entry system) with the ignition switch in the LOCK position

- remain on for a period of time.
- any door is opened
- remain on while the door is opened. When the door is closed, the lights go off.

ROOM LIGHT (where fitted)

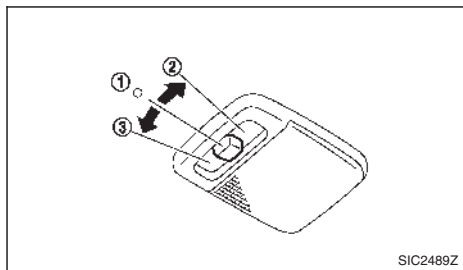

The room light has a three-position switch.

When the switch is in the ON position ②, the room light illuminates.

When the switch is in the <○> (Door) position ①, the room light illuminates when a door is opened.

The interior light timer will keep the room light on for a period of time when:

The key is removed from the ignition switch with all doors closed (models without Remote Control Key).

The ignition switch is placed in the OFF position with all doors closed (models with Remote Control Key).

The driver's door is unlocked without the key in the ignition switch (models without Remote Control Key).

The driver's door is unlocked when the ignition switch is in the LOCK position (models with Remote Control Key).

The doors are unlocked with the UNLOCK  button (model with remote keyless entry system).

The last door is closed without the key in the ignition switch (models without Remote Control Key).

The interior light timer will be cancelled when:

The driver's door is locked.

The ignition switch is placed in the ON position.

When the switch is in the OFF position ③, the room light does not illuminate, regardless of any condition.

REAR PERSONAL LIGHT (where fitted)

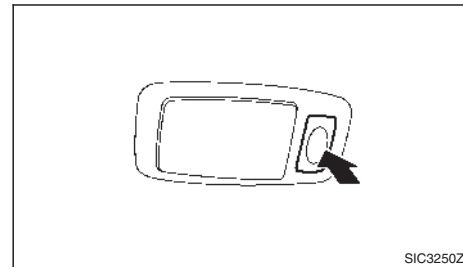

To turn the rear personal lights on, push the switch. To turn them off, push the switch again.

VANITY MIRROR LIGHTS (where fitted)

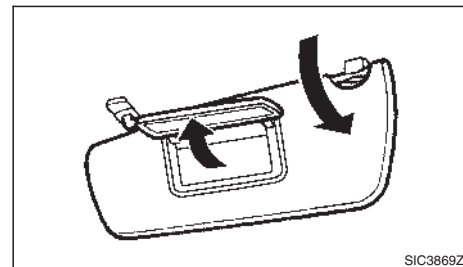

To access the vanity mirror, pull the sun visor down and flip open the mirror cover.

The vanity mirror light illuminates when the vanity mirror cover is opened. When the cover is closed, the light will turn off.

BATTERY SAVER SYSTEM

The lights will turn off after a period of time when the lights remain illuminated to prevent the battery from becoming discharged.

3 Pre-driving checks and adjustments

Keys.....	3-2	Anti-Theft System (ATS).....	3-16
Key (where fitted).....	3-2	Bonnet.....	3-17
Anti-Theft System (ATS*) key (where fitted).....	3-2	Opening bonnet.....	3-17
Remote Control Key (where fitted).....	3-2	Closing bonnet.....	3-17
Doors.....	3-4	Fuel filler lid and cap.....	3-18
Locking with key.....	3-4	Opening fuel filler lid.....	3-18
Opening with inside door handle.....	3-4	Fuel filler cap.....	3-18
Locking with power door lock switch.....	3-4	AdBlue® filler lid and cap.....	3-19
Rear access doors (King Cab models).....	3-5	Opening AdBlue® filler lid.....	3-19
Child safety rear door locks (Double Cab models).....	3-5	Locking AdBlue® filler lid.....	3-19
AdBlue® filler cap.....	3-19		
Remote keyless entry system (where fitted).....	3-6	AdBlue® filler cap.....	3-19
Using remote keyless entry system.....	3-6	Cargo bed (where fitted).....	3-20
Remote Control Key system (where fitted).....	3-7	Tailgate.....	3-20
Remote Control Key operating range.....	3-8	Tie down hooks (where fitted).....	3-20
Using Remote Control Key system.....	3-8	C-Channel system (where fitted).....	3-21
Battery saver system.....	3-10	Steering wheel.....	3-23
Warning and audible reminders.....	3-10	Steering wheel adjustment.....	3-23
Troubleshooting guide.....	3-12	Mirrors.....	3-23
Using remote keyless entry system.....	3-14	Inside rearview mirror.....	3-23
Hazard indicator and horn operation.....	3-15	Outside rearview mirrors.....	3-25
Security system (where fitted).....	3-15	Vanity mirror (where fitted).....	3-26
Theft warning system (where fitted).....	3-15	Parking brake.....	3-26

KEYS

A key number plate is supplied with your key. Record the key number on the key number plate/metal tag and keep it in a safe place (such as your wallet), **NOT IN THE VEHICLE**. RENAULT does not record key numbers so it is very important to keep track of your key number plate.

A key number is only necessary when you have lost all keys and do not have one to duplicate from. If you still have a key, this key can be duplicated by an approved dealer or qualified workshop.

KEY (where fitted)

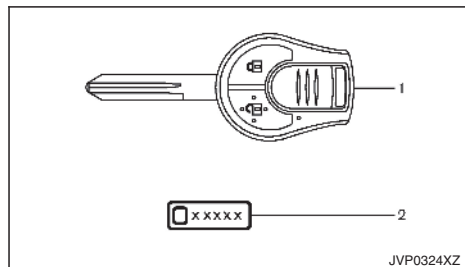

1. Master key (with integrated key fob) (2)
2. Key number plate (1)

As many as 5 master keys with integrated key fob can be registered and used with one vehicle.

ANTI-THEFT SYSTEM (ATS*) KEY (where fitted)

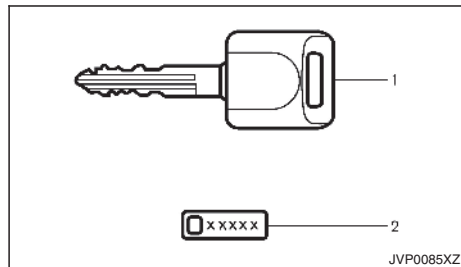

1. ATS key (moulded) (2)
2. Key number plate (1)

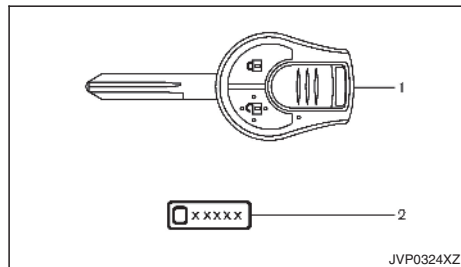

1. ATS key (with integrated key fob) (2)
2. Key number plate (1)

Your vehicle can only be driven with the ATS keys, which are registered to your vehicle's ATS components. As many as 5 ATS keys can be registered and

used with one vehicle. The new keys must be registered by an approved dealer or qualified workshop prior to use with the ATS of your vehicle. Since the registration process requires erasing all memory in the ATS components when registering new keys, be sure to take all ATS keys that you have to the approved dealer or qualified workshop.

CAUTION

Do not allow the ATS key, which contains an electrical transponder, to come into contact with water or salt water. This could affect the system function.

*: Immobilizer

REMOTE CONTROL KEY (where fitted)

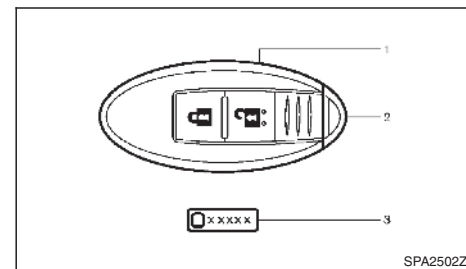

1. Remote Control Key (2)
2. Mechanical key (inside Remote Control Key) (2)
3. Key number plate (1)



WARNING

The Remote Control Key transmits radio waves that can adversely affect medical electric equipment.

If you have a pacemaker, you should contact the medical equipment manufacturer to ask if it will be affected by the Remote Control Key signal.

Your vehicle can only be driven with the Remote Control Keys which are registered to your vehicle's Remote Control Key system components and Anti-Theft System (ATS*) components. As many as 4 Remote Control Keys can be registered and used with one vehicle. The new keys must be registered by an approved dealer or qualified workshop prior to use with the Remote Control Key system and ATS of your vehicle. Since the registration process requires erasing all memory in the Remote Control Key system components when registering new keys, be sure to take all Remote Control Keys that you have to an approved dealer or qualified workshop.

*: Immobilizer

CAUTION

Be sure to carry the Remote Control Key with you. Do not leave the vehicle with the Remote Control Key inside.

Be sure to carry the Remote Control Key with you when driving. The Remote Control Key is a precision device with a built-in transmitter. To avoid damaging it, please note the following.

- The Remote Control Key is water resistant; however, wetting may damage the Remote

Control Key. If the Remote Control Key gets wet, immediately wipe until it is completely dry.

- Do not bend, drop or strike it against another object.
- If the outside temperature is below -10°C (14°F), the battery of the Remote Control Key may not function properly.
- Do not place the Remote Control Key for an extended period in a place where temperatures exceed 60°C (140°F).
- Do not change or modify the Remote Control Key.
- Do not use a magnet key holder.
- Do not place the Remote Control Key near equipment that produces a magnetic field such as a TV, audio equipment and personal computers.
- Do not allow the Remote Control Key to come into contact with water or salt water, and do not wash it in a washing machine. This could affect the system function.

If a Remote Control Key is lost or stolen, RENAULT recommends erasing the ID code of that Remote Control Key. This will prevent the Remote Control Key from unauthorised use to unlock the vehicle. For information regarding the erasing procedure, please contact an approved dealer or qualified workshop.

Mechanical key

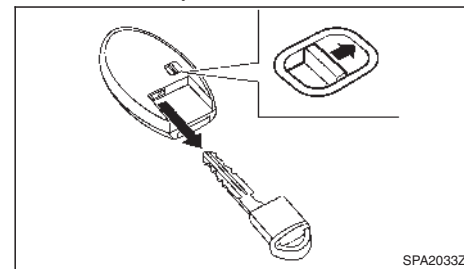

To remove the mechanical key, release the lock knob on the back of the Remote Control Key.

To install the mechanical key, firmly insert it into the Remote Control Key until the lock knob returns to the lock position.

Use the mechanical key to lock or unlock the doors and tailgate (where fitted). (See "Doors" later in this section and "Tailgate" later in this section.)

DOORS



WARNING

Always look before opening any doors, to avoid an accident with oncoming traffic.

To help avoid risk of injury or death through unintended operation of the vehicle and/or its systems, do not leave children, people who require the assistance of others, or pets unattended in your vehicle. Additionally, the temperature inside a closed vehicle on a warm day can quickly become high enough to cause a significant risk of injury or death to people and pets.

OPENING WITH INSIDE DOOR HANDLE

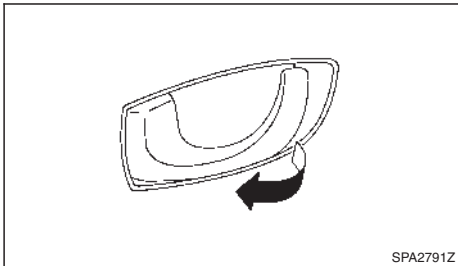

To unlock and open the door pull the inside door handle as illustrated.

For models with Super Lock System:

The doors cannot be opened by using the inside door handle when the Super Lock System is activated.

LOCKING WITH POWER DOOR LOCK SWITCH

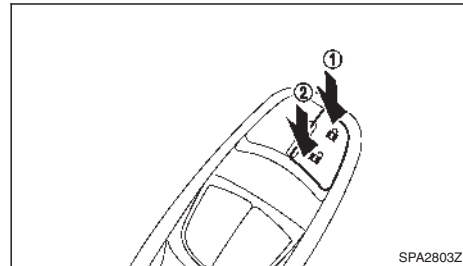

Operating the power door lock switch (located on the driver's door) will lock or unlock all the doors.

To lock the doors, push the power door lock switch to the lock position ① with the driver's door open, then close the door. All doors will lock.

LOCKING WITH KEY

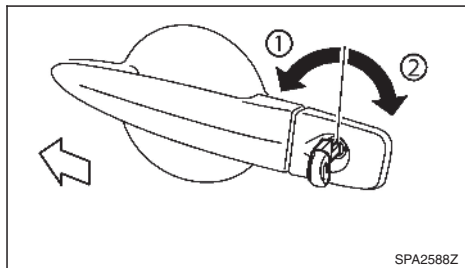

To lock the door, insert the mechanical key to the door key cylinder and turn the key to the front side of the vehicle ①.

To unlock the door, turn the key to the rear of the vehicle ②.

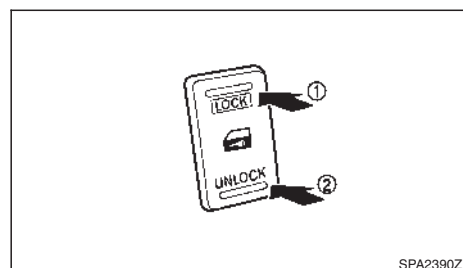

CAUTION

When locking the doors using the power door lock switch, be sure not to leave the key in the vehicle.

When the Remote Control Key (where fitted) is left in the vehicle, and you try to lock the door using the power door lock switch after getting out of the vehicle, all the doors will unlock automatically after the door is closed.

To unlock, push the power door lock switch to the unlock position ②.

REAR ACCESS DOORS (King Cab models)

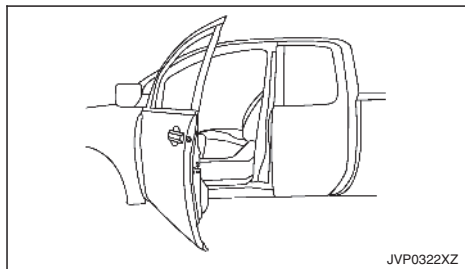

1. Open the driver's or passenger's door.

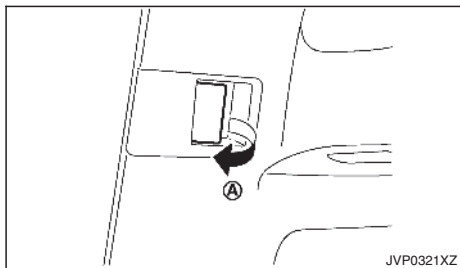

2. From the inside, pull the door handle (A) toward the front of the vehicle.

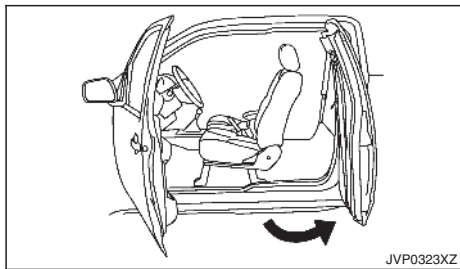

3. Open the door to the desired position.

CHILD SAFETY REAR DOOR LOCKS (Double Cab models)

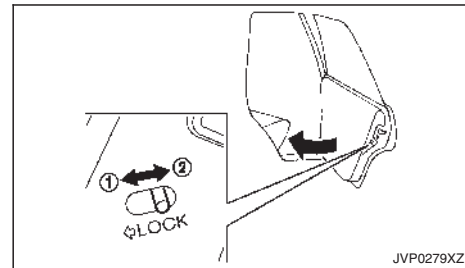

The child safety rear door locks help prevent rear doors from being opened accidentally, especially when small children are in the vehicle.

When the levers are in the lock position ①, the child safety rear door locks engage and the rear doors can only be opened by the outside door handles.

To disengage, move the levers to the unlock position ②.

REMOTE KEYLESS ENTRY SYSTEM (where fitted)

The remote keyless entry system can operate all door locks using the integrated key fob. The integrated key fob can operate at a distance of approximately 1 m (3.3 ft) away from the vehicle. The operating distance depends upon the conditions around the vehicle.

As many as 5 integrated key fobs can be used with one vehicle. For information about the purchase and use of additional integrated key fobs, contact an approved dealer or qualified workshop.

The integrated key fob will not function under the following conditions:

When the distance between the integrated key fob and vehicle is more than approximately 1 m (3.3 ft).

When the integrated key fob battery is discharged.

When the key is in the ignition switch.

CAUTION

When locking the doors using the integrated key fob, be sure not to leave the key in the vehicle.

Do not allow the integrated key fob, which contains electrical components, to come into contact with water or salt water. This could affect the system function.

Do not drop the integrated key fob.

Do not strike the remote controller sharply against another object.

Do not place the integrated key fob for an extended period in an area where temperatures exceed 60°C (140°F).

If a integrated key fob is lost or stolen, RENAULT recommends erasing the ID code of that integrated key fob from the vehicle. This may prevent the unauthorised use of the integrated key fob to unlock the vehicle. For information regarding the erasing procedure, contact an approved dealer or qualified workshop.

For information regarding the replacement of a battery, see "Remote controller battery replacement" in the "8. Maintenance and do-it-yourself" section.

USING REMOTE KEYLESS ENTRY SYSTEM



WARNING

For Super Lock System equipped models, failure to follow the precautions below may lead to hazardous situations. Make sure the Super Lock System activation is always safely conducted.

When the vehicle is occupied, never lock the doors with the integrated key fob. Doing so will trap the occupants, since the Super Lock System prevents the doors from being opened from the inside of the vehicle.

Only operate the integrated key fob lock button when there is a clear view of the vehicle. This is to prevent anybody from being trapped inside the vehicle through the Super Lock System activation.

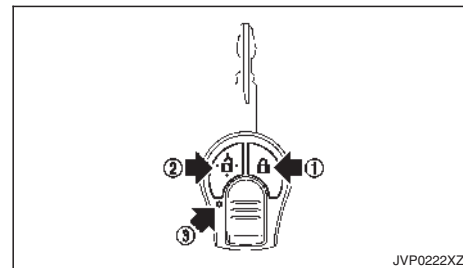

- ① LOCK button
- ② UNLOCK button
- ③ Battery indicator light

Locking doors

1. Remove the ignition key.
2. Close all doors.
3. Push the LOCK button ① on the integrated key fob.
4. All doors and the AdBlue® filler lid will be locked.
5. Operate door handles to confirm that the doors have been securely locked.

CAUTION

After locking the doors using the integrated key fob, be sure that the doors have been securely locked by operating the door handles.

REMOTE CONTROL KEY SYSTEM (where fitted)

Unlocking doors

1. Push the UNLOCK  button ② on the integrated key fob.
2. All doors and the AdBlue® filler lid will be unlocked.

All doors will be locked automatically unless one of the following operations is performed within 30 seconds after pushing the UNLOCK  button ②.

Opening any doors.

Inserting the key into the ignition switch.

Battery indicator light

The battery indicator light ③ illuminates when you push any button. If the light does not illuminate, the battery is weak or needs replacement. For information regarding replacement of a battery, see "Remote controller battery replacement" in the "8. Maintenance and do-it-yourself" section.

Hazard indicator operation

When you lock or unlock the doors, the hazard indicator will flash as a confirmation.

LOCK: The hazard indicator flashes once.

UNLOCK: The hazard indicator flashes twice.



WARNING

Radio waves could adversely affect electric medical equipment. Those who use a pacemaker should contact the electric medical equipment manufacturer for the possible influences before use.

The Remote Control Key transmits radio waves when the buttons are pushed. The radio waves may affect aircraft navigation and communication systems. Do not operate the Remote Control Key while on an aeroplane. Make sure the buttons are not operated unintentionally when the unit is stored during a flight.

The Remote Control Key system can operate all doors using the integrated key fob function or pushing the request switch on the vehicle without taking the key out from a pocket or purse. The operating environment and/or conditions may affect the Remote Control Key system operation.

Be sure to read the following before using the Remote Control Key system.

CAUTION

Be sure to carry the Remote Control Key with you when operating the vehicle.

Never leave the Remote Control Key in the vehicle when you leave the vehicle.

The Remote Control Key is always communicating with the vehicle as it receives radio waves. The Remote Control Key system transmits weak radio waves. Environmental conditions may interfere with the operation of the Remote Control Key system under the following operating conditions.

When operating near a location where strong radio waves are transmitted, such as a TV tower, power station and broadcasting station.

When in possession of wireless equipment, such as a mobile telephone, transceiver, and CB radio.

When the Remote Control Key is in contact with or covered by metallic materials.

When any type of radio wave remote control is used nearby.

When the Remote Control Key is placed near an electric appliance such as a personal computer.

In such cases, correct the operating conditions before using the Remote Control Key function or use the mechanical key.

Although the life of the battery varies depending on the operating conditions, the battery's life is approximately 2 years. If the battery is discharged, replace it with a new one.

For information regarding replacement of a battery, see "Remote Control Key battery replacement" in the "8. Maintenance and do-it-yourself" section.

Since the Remote Control Key is continuously receiving radio waves, if the key is left near equipment which transmits strong radio waves, such as signals from a TV and personal computer, the battery life may become shorter.

Because the steering wheel is locked electrically, unlocking the steering wheel with the ignition switch in the LOCK position is impossible when the vehicle battery is completely discharged. Pay special attention that the vehicle battery is not completely discharged.

As many as 4 Remote Control Keys can be registered and used with one vehicle. For information about the purchase and use of additional Remote Control Keys, contact an approved dealer or qualified workshop.

CAUTION

Do not allow the Remote Control Key, which contains electrical components, to come into contact with water or salt water. This could affect the system function.

Do not drop the Remote Control Key.

Do not strike the Remote Control Key sharply against another object.

Do not change or modify the Remote Control Key.

Wetting may damage the Remote Control Key. If the Remote Control Key gets wet, immediately wipe until it is completely dry.

If the outside temperature is below -10°C (14°F), the battery of the Remote Control Key may not function properly.

Do not place the Remote Control Key for an extended period in an area where temperatures exceed 60°C (140°F).

Do not attach the Remote Control Key to a key holder that contains a magnet.

Do not place the Remote Control Key near equipment that produces a magnetic field, such as a TV, audio equipment and personal computers.

If a Remote Control Key is lost or stolen, RENAULT recommends erasing the ID code of that Remote Control Key from the vehicle. This may prevent the unauthorised use of the Remote Control Key to operate the vehicle. For information regarding the erasing procedure, contact an approved dealer or qualified workshop.

The Remote Control Key function can be disabled. For information about disabling the Remote Control Key function, contact an approved dealer or qualified workshop.

REMOTE CONTROL KEY OPERATING RANGE

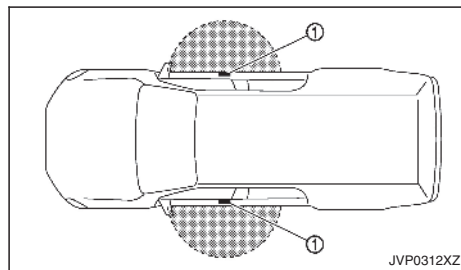

The Remote Control Key functions can only be used when the Remote Control Key is within the specified operating range from the request switch ①.

When the Remote Control Key battery is discharged or strong radio waves are present near the operating location, the Remote Control Key system's operating range becomes narrower, and the Remote Control Key may not function properly.

The operating range is within 80 cm (31.50 in) from each request switch ①.

If the Remote Control Key is too close to the door glass or door handle, the request switches may not function.

When the Remote Control Key is within the operating range, it is possible for anyone, even someone who does not carry the Remote Control Key, to push the request switch to lock/unlock the doors.

USING REMOTE CONTROL KEY SYSTEM

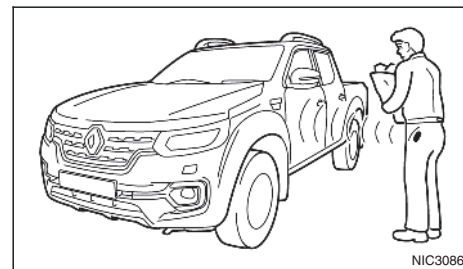

The request switch will not function under the following conditions:

When another Remote Control Key is left inside the vehicle

When the Remote Control Key is not within the operational range

When any door is open or not closed securely

When the Remote Control Key battery is discharged

When the ignition switch is in the **ACC** or **ON** position

The Remote Control Key system (opening/closing doors with the door handle request switch) can be set to remain inactive. (See “[Vehicle Settings]” in the “2. Instruments and controls” section.)

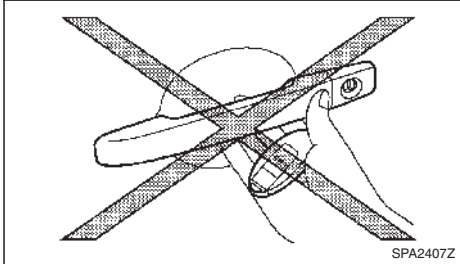

Do not push the door handle request switch with the Remote Control Key held in your hand as illustrated. The close distance to the door handle will cause the Remote Control Key system to have difficulty recognising that the Remote Control Key is outside the vehicle.

After locking the doors using the door handle request switch, make sure that the doors have been securely locked by operating the door handles.

When locking the doors using the door handle request switch, make sure to have the Remote Control Key in your possession before operating the door handle request switch to prevent the Remote Control Key from being left in the vehicle.

The door handle request switch is operational only when the Remote Control Key has been detected by the Remote Control Key system.

Do not pull the door handle before pushing the door handle request switch. The door will be unlocked but will not open. Release the door handle once and pull it again to open the door.

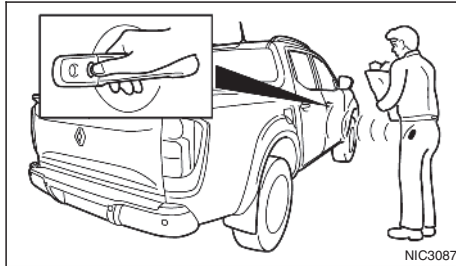

When you carry the Remote Control Key with you, you can lock or unlock all doors by pushing the door handle request switch ① (driver's or front passenger's door) within the range of operation.

When you lock or unlock the doors, the hazard indicator will flash as a confirmation.

Locking doors

1. Push the ignition switch to the **OFF** position.
2. Carry the Remote Control Key with you.
3. Close all doors.
4. Push the door handle request switch ① (driver's or front passenger's door).
5. All doors and the AdBlue® filler lid will be locked.

6. Operate door handles to confirm that the doors have been securely locked.

Lockout protection:

To prevent the Remote Control Key from being accidentally locked in the vehicle, lockout protection is equipped with the Remote Control Key system.

When the Remote Control Key is left in the vehicle and you try to lock the door using the power door lock switch after getting out of the vehicle, all the doors will unlock automatically and a chime will sound after the door is closed.

CAUTION

The lockout protection may not function under the following conditions:

When the Remote Control Key is placed on top of the instrument panel.

When the Remote Control Key is placed inside of the glove box.

When the Remote Control Key is placed inside of the door pockets.

When the Remote Control Key is placed inside or near metallic materials.

The lockout protection may function when the Remote Control Key is outside the vehicle but is too close to the vehicle.

Unlocking doors

1. Carry the Remote Control Key with you.
2. Push the door handle request switch ①.
3. All doors and the AdBlue® filler lid will be unlocked.

If a door handle is pulled while unlocking the doors, that door may not be unlocked. Returning the door handle to its original position will unlock the door. If the door does not unlock, after returning the door handle, push the door handle request switch to unlock the door.

Automatic relock:

All doors will be locked automatically unless one of the following operations is performed within 30 seconds after pushing the request switch while the doors are locked.

Opening any doors.

Pushing the ignition switch.

If during the preset time period the UNLOCK  button on the Remote Control Key is pushed, all doors will be locked automatically after the next preset time.

BATTERY SAVER SYSTEM

When all the following conditions are met for a period of time, the battery saver system will cut off the power supply to prevent battery discharge.

The ignition switch is in the **ACC** or **ON** position.

All doors are closed.

The shift lever is in the P (Park) position (automatic transmission model).

WARNING AND AUDIBLE REMINDERS

The Remote Control Key system is equipped with a function that is designed to minimise improper operations of the Remote Control Key and to help prevent the vehicle from being stolen. A chime or beep sounds inside and outside the vehicle and a warning message appears in the vehicle information display.

See the troubleshooting guide on the next page and “Vehicle information display” in the “2. Instruments and controls” section.

CAUTION

When the chime or beep sounds or the warning message appears, be sure to check both the vehicle and the Remote Control Key.

TROUBLESHOOTING GUIDE

Symptom		Possible cause	Action to take
When pushing the ignition switch to stop the engine	The Shift to Park warning appears in the vehicle information display and the inside warning chime sounds continuously or for a few seconds. (Automatic Transmission models)	The shift lever is not in the P (Park) position.	Shift the shift lever to the P (Park) position.
When shifting the shift lever to the P (Park) position	The inside warning chime sounds continuously. (Automatic Transmission models)	The ignition switch is in the ACC or ON position.	Push the ignition switch to the OFF position.
When opening the driver's door to get out of the vehicle	The inside warning chime sounds continuously.	The ignition switch is in the ACC position.	Push the ignition switch to the OFF position.
When closing the door after getting out of the vehicle	The No Key Detected warning appears on the display, the outside chime sounds 3 times and the inside warning chime sounds for a few seconds.	The ignition switch is in the ACC or ON position.	Push the ignition switch to the OFF position.
	The Shift to Park warning appears in the vehicle information display and the outside chime sounds continuously. (Automatic Transmission models)	The ignition switch is in the ACC or OFF position and the shift lever is not in the P (Park) position.	Move the shift lever to the P (Park) position and push the ignition switch to the OFF position.
When pushing the request switch or the LOCK  button on the Remote Control Key to lock the door	The outside chime sounds for a few seconds and all the doors unlock.	The Remote Control Key is inside the vehicle.	Carry the Remote Control Key with you.
When closing the door with the inside lock knob turned to LOCK	The outside chime sounds for a few seconds and all the doors unlock.	The Remote Control Key is inside the vehicle.	Carry the Remote Control Key with you.

Symptom		Possible cause	Action to take
When pushing the door handle request switch to lock the door	The outside chime sounds for a few seconds.	The Remote Control Key is inside the vehicle.	Carry the Remote Control Key with you.
		A door is not closed securely.	Close the door securely.
		The door handle request switch is pushed before the door is closed.	Push the door handle request switch after the door is closed.
When pushing the ignition switch to start the engine	The Key Battery low warning appears in the vehicle information display.	The battery charge is low.	Replace the battery with a new one. (See "Remote Control Key battery replacement" in the "8. Maintenance and do-it-yourself" section.)
	The No Key Detected warning appears in the display and the inside warning chime sounds for a few seconds.	The Remote Control Key is not in the vehicle.	Carry the Remote Control Key with you.
When pushing the ignition switch	The Key System Error warning appears in the vehicle information display.	It warns of a malfunction with the electrical steering lock system (where fitted) or the Remote Control Key system.	Contact an approved dealer or qualified workshop.

USING REMOTE KEYLESS ENTRY SYSTEM

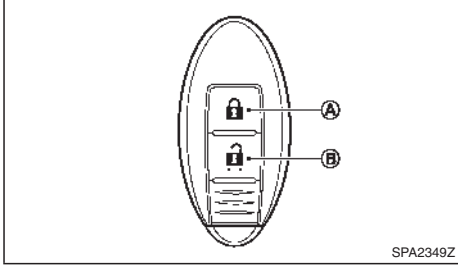

Ⓐ LOCK button

Ⓑ UNLOCK button

Operating range

The remote keyless entry system allows you to lock/unlock all doors. The operating distance depends upon the conditions around the vehicle. To securely operate the lock and unlock buttons, approach the vehicle to about 1 m (3.3 ft) from the door.

The remote keyless entry system will not function under the following conditions:

When the Remote Control Key is not within the operational range.

When the Remote Control Key battery is discharged.

For information regarding the replacement of a battery, see "Remote Control Key battery replacement" in the "8. Maintenance and do-it-yourself" section.

Locking doors

1. Place the ignition switch to the **OFF** position.
2. Carry the Remote Control Key with you.
3. Close all doors.
4. Push the LOCK button Ⓐ on the Remote Control Key.
5. All doors will be locked.
6. Operate the door handles to confirm that the doors have been securely locked.

CAUTION

After locking the doors using the Remote Control Key, be sure that the doors have been securely locked by operating the door handles.

When locking the doors using the Remote Control Key, be sure not to leave the key in the vehicle.

Unlocking doors

1. Push the UNLOCK button Ⓑ on the Remote Control Key.
2. All doors will be unlocked.

Automatic relock:

All doors will be locked automatically unless one of the following operations is performed within 30 seconds after pushing the UNLOCK Ⓑ button on the Remote Control Key while the doors are locked.

Opening any doors.



Pushing the ignition switch.

If during the preset time period the UNLOCK Ⓑ button on the Remote Control Key is pushed, all doors will be locked automatically after the next preset time.

HAZARD INDICATOR AND HORN OPERATION

When you lock or unlock the doors, the hazard indicator will flash and the horn (or the outside chime) will sound as a confirmation.

The following descriptions show how the hazard indicator and horn/chime will activate when locking or unlocking the doors.

Operation	DOOR LOCK	DOOR UNLOCK
Remote Control Key system (using request switch)	HAZARD - once OUTSIDE CHIME - once	HAZARD - twice OUTSIDE CHIME - twice
Remote keyless entry system (using  or  button)	HAZARD - once HORN - once	HAZARD - twice HORN - twice

Your vehicle has either or both of the following security systems:

- Theft warning system
- Anti-Theft System (ATS*)

*: Immobilizer

The security condition will be shown by the security indicator light.

THEFT WARNING SYSTEM (where fitted)

The theft warning system provides visual and audio alarm signals if parts of the vehicle are disturbed.

Security indicator light

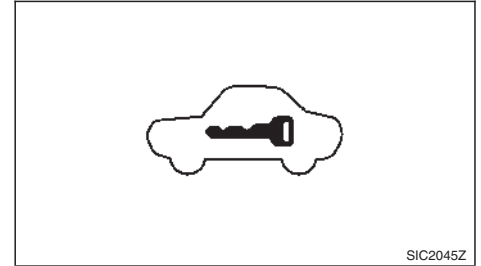

SIC2045Z

The security indicator light, located on the meter panel, operates whenever the ignition switch is in the LOCK, OFF or ACC position. This is normal.

How to activate system (where fitted)

1. Close all windows.

The system can be armed even if the windows are open.

2. Place the ignition switch in the OFF position.
3. Carry the integrated key fob or the Remote Control Key with you and get out of the vehicle.
4. Close and lock all doors. The doors can be locked with the integrated key fob, the Remote Control Key, door handle request switch (where fitted), power door lock switch or mechanical key.
5. Confirm that the security indicator light comes on. The security indicator light glows for about 30 seconds and then blinks. The system is now activated. If, during this 30 second time period, the door is unlocked or the ignition switch is placed in the ACC or ON position, the system will not activate.

Even when the driver and/or passengers are in the vehicle, the system will activate with all doors locked with the ignition switch in the LOCK position. When pushing the ignition switch to the ACC or ON position, the system will be released.

Theft warning system operation

The vehicle security system will give the following alarm:

The hazard indicator blinks and the horn sounds intermittently.

The alarm automatically turns off after approximately 30 seconds. However, the alarm reactivates if the vehicle is tampered with again.

The alarm is activated by:

Unlocking the door without using the integrated key fob, the Remote Control Key, the door handle request switch (where fitted) or the mechanical key. (Even if the door is opened by releasing the door inside lock knob, the alarm will activate.)

How to stop alarm

The alarm will stop only by unlocking a door by pushing the UNLOCK button on the Remote Control Key.

The alarm will not stop if the ignition switch is placed in the ACC or ON position.

ANTI-THEFT SYSTEM (ATS)

The Anti-Theft System (ATS) will not allow the engine to start without the use of the registered ATS key.

If the engine does not start using the registered ATS key, it may be due to interference caused by:

- Another ATS key.
- Automated toll road device.
- Automated payment device.
- Other devices that transmit similar signals.

Start the engine using the following procedure:

1. Remove any items that may be causing the interference away from the ATS key.
2. Leave the ignition switch in the ON position for approximately 5 seconds.
3. Place the ignition switch in the OFF or LOCK position, and wait approximately 10 seconds.
4. Repeat steps 2 and 3 again.

5. Start the engine.

6. Repeat the steps above until all possible interferences are eliminated.

If this procedure allows the engine to start, RENAULT recommends placing the registered ATS key separate from other devices to avoid interference.

If ATS is malfunctioning, this light will remain on while the ignition switch is in the ON position.

If the light remains on and/or the engine does not start, contact an approved dealer or qualified workshop for ATS service as soon as possible. Be sure to bring all Remote Control Keys that you have when visiting an approved dealer for service.

BONNET



WARNING

The bonnet must be closed and latched securely before driving. Failure to do so could cause the bonnet to fly open and result in an accident.

Never open the bonnet if steam or smoke is coming from the engine compartment to avoid injury.

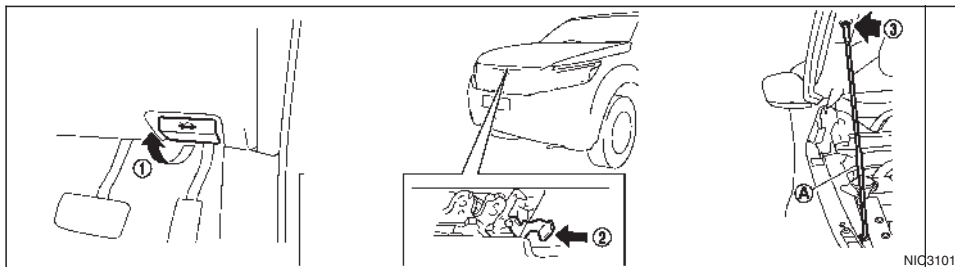

OPENING BONNET

1. Pull the bonnet lock release handle ① located below the instrument panel until the bonnet springs up.
2. Locate the lever ② in between the bonnet and grille and push the lever with your fingertips.
3. Raise the bonnet.
4. Remove the support rod and insert it into the slot ③.

Hold the coated parts ④ when removing or resetting the support rod. Avoid direct contact with the metal parts, as they may be hot immediately after the engine has been stopped.

CLOSING BONNET

1. While supporting the bonnet, return the support rod to its original position.
2. Slowly lower the bonnet to about 20 to 30 cm (8 to 12 in) above the bonnet lock, then let it drop.
3. Make sure it is securely latched.

FUEL FILLER LID AND CAP



WARNING

Fuel is extremely flammable and highly explosive under certain conditions. You could be burned or seriously injured if it is misused or mishandled. Always stop the engine and do not smoke or allow open flames or sparks near the vehicle when refuelling.

Fuel may be under pressure. Turn the cap a half of a turn, and wait for any "hissing" sound to stop to prevent fuel from spraying out and possibly causing personal injury. Then remove the cap.

Use only an original equipment type fuel filler cap as a replacement. It has a built-in safety valve needed for proper operation of the fuel system and emission control system. An incorrect cap can result in a serious malfunction and possible injury.

OPENING FUEL FILLER LID

Fuel filler lid opener switch

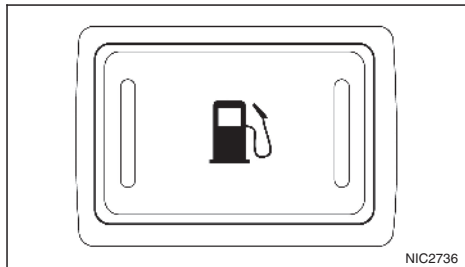

To open the fuel filler lid, push the fuel filler lid opener switch located on the lower side of the instrument panel.

To lock the fuel filler lid, close the lid until it securely locks.

FUEL FILLER CAP

Type A

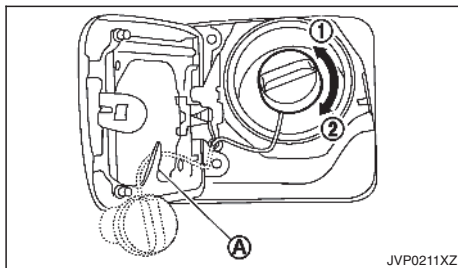

The fuel filler cap is a ratcheting type. Turn the cap anticlockwise ① to remove. Tighten the cap clockwise ② until ratchet clicks, more than twice, after refuelling.

Put the fuel filler cap on the cap holder (A) while refuelling.

CAUTION

If fuel is spilled on the vehicle body, flush it away with water to avoid paint damage.

Type B

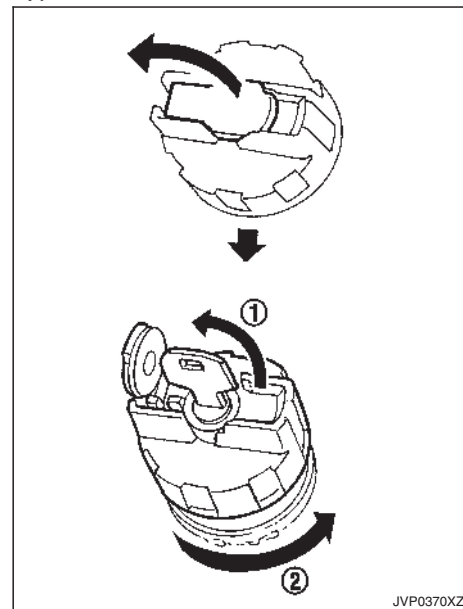

To open the fuel filler cap, turn the key anticlockwise ①.

Turn the fuel filler cap anticlockwise ② after the cap is unlocked.

AdBlue® FILLER LID AND CAP

The fuel filler cap is a screw-on ratcheting type. After refuelling, tighten the cap clockwise until more than 2 ratcheting clicks are heard. The fuel filler cap locks automatically when it is tightened.

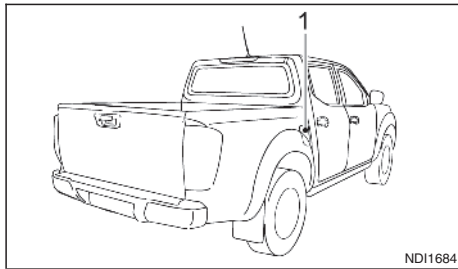

The AdBlue® filler lid ① is located on the right hand side of the vehicle.

OPENING AdBlue® FILLER LID

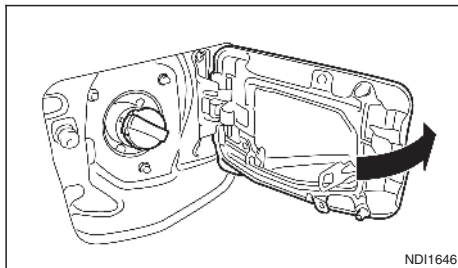

To open the AdBlue® filler lid, push the AdBlue® filler lid slightly and release.

To close the AdBlue® filler lid, close the lid until it securely locks in place.

LOCKING AdBlue® FILLER LID

The AdBlue® filler lid is locked and unlocked using the Keyless Entry System, see "Remote Control Key system (where fitted)" earlier in this section for additional details.

AdBlue® FILLER CAP

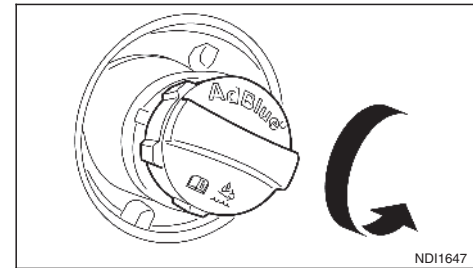

The AdBlue® filler cap is a non-ratcheting type. Turn the cap anticlockwise ① to remove. Tighten the cap clockwise ② until tight.

CAUTION

If AdBlue® is spilled on the vehicle body, flush it away with water to avoid paint damage.

CARGO BED (where fitted)



WARNING

While driving, never allow anyone to ride in the cargo area. Abrupt braking or stopping could lead to personal injury or death.

Do not drive the vehicle with the tailgate down.

Properly secure all cargo with ropes or straps to help prevent it from sliding or shifting. In a sudden stop or collision, unsecured cargo could cause personal injury.

TAILGATE

Locking or unlocking tailgate (where fitted)

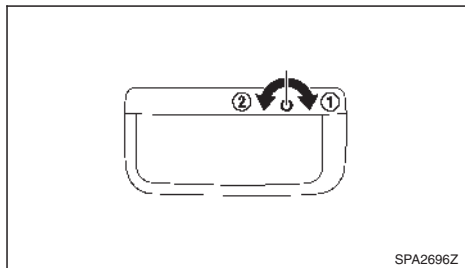

To lock the tailgate, insert the key to the tailgate key cylinder and turn the key clockwise ①.

To unlock the tailgate, turn the key anticlockwise ②.

For Remote Control Key equipped models, see "Mechanical key" earlier in this section for removing the mechanical key.

Opening the tailgate

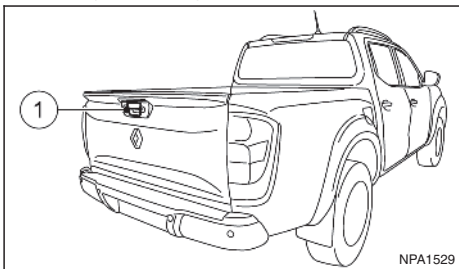

To open the tailgate, pull the tailgate handle ① and lower the tailgate. The support wires will hold the gate open.

The weight of the cargo load must be evenly distributed over both the front and the rear axles.

All cargo should be securely fastened with ropes or straps to prevent it from shifting or sliding within the vehicle.



WARNING

Do not drive the vehicle with the tailgate down.

While driving, never allow anyone to ride in the cargo area. Abrupt braking or stopping could lead to personal injury or death.

Closing the tailgate

When closing the tailgate, make sure that the latches or levers are securely locked.

TIE DOWN HOOKS (where fitted)

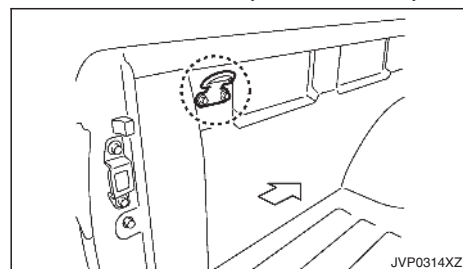

For your convenience, four tie down hooks are placed on the inside of the cargo bed. These may be used to help secure cargo loaded into the cargo bed.

The weight of the cargo load must be evenly distributed over both the front and rear axles.

All cargo should be securely fastened with ropes or straps to prevent it from shifting or sliding within the vehicle.

C-CHANNEL SYSTEM (where fitted)



WARNING

Properly install and tighten the tie-down cleats into the C-Channel system. Also, do not attach any rope or straps directly to the channel. Failure to properly install the tie-down cleats or attaching ropes or straps directly to the channel can cause the cargo to become unsecured. In a sudden stop or collision, unsecured cargo could cause personal injury.

Properly secure all cargo with ropes or straps to help prevent it from sliding or shifting. In a sudden stop or collision, unsecured cargo could cause personal injury.

Do not place cargo higher than the seatbacks. In a sudden stop or collision, unsecured cargo could cause personal injury.

Overloading not only can shorten the life of your vehicle and the tyre, but can also cause unsafe vehicle handling and longer braking distances. This may cause a premature tyre failure which could result in a serious accident and personal injury. Failures caused by overloading are not covered by the vehicle's warranty.

Do not install accessories over the gap between the front and rear side channels. Doing so could affect the rear structure in certain rear impacts, which could result in serious injury.

The C-Channel system allows you to move tie-down clamps in the bed to the best location to secure a load.

The tie-down cleats must be installed so the clamp is properly seated in the notches in the rail. If the tie-down cleat is not seated in the notches, it will not be properly tightened. The bolt in the centre of the cleat must be securely tightened.

Check the tightness of the tie-down cleat periodically during a trip to make sure the centre bolt has not become loose.

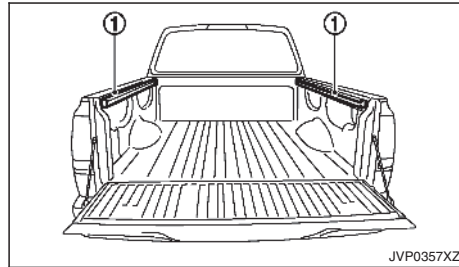

① Side channels

Install the tie-down cleat as follows:

1. Loosen the centre bolt completely.

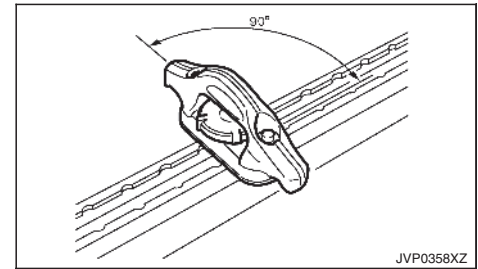

2. Insert the cleat into the channel perpendicular to the channel as shown. Then rotate the cleat clockwise 90° and slide it to desired location.

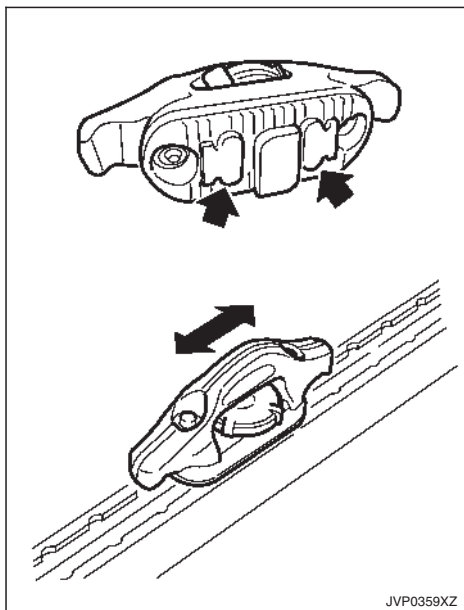

3. Position the cleat so the nubs on the bottom fully seat into the channel detents.

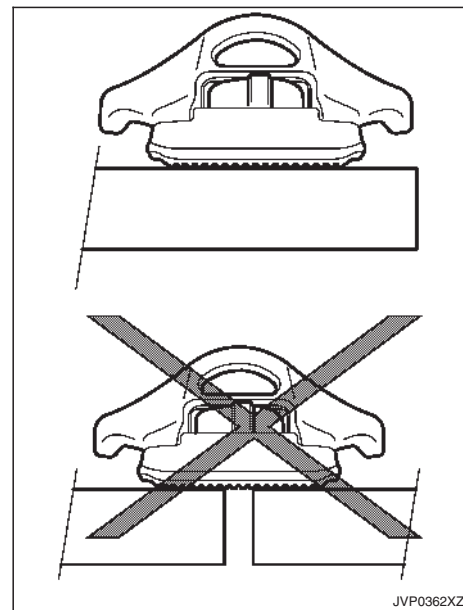
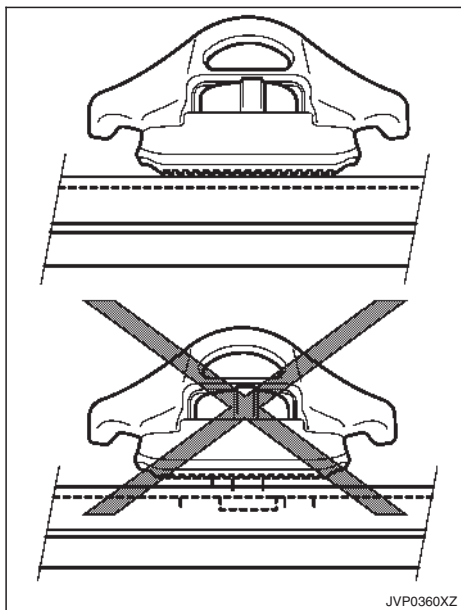

4. There should be no gap between the bottom of the cleat and the top of the channel. Securely tighten the centre bolt.

STEERING WHEEL

STEERING WHEEL ADJUSTMENT



WARNING

Never adjust the steering wheel while driving so that full attention may be given to vehicle operation.

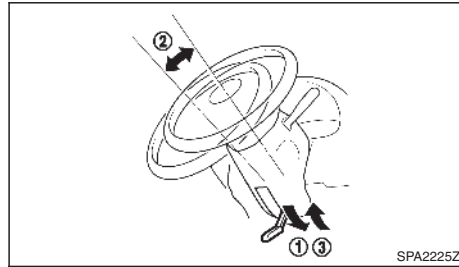

Pull the lock lever down ① and adjust the steering wheel up or down ② until the desired position is achieved.

Push the lock lever back ③ firmly to lock the steering wheel in place.

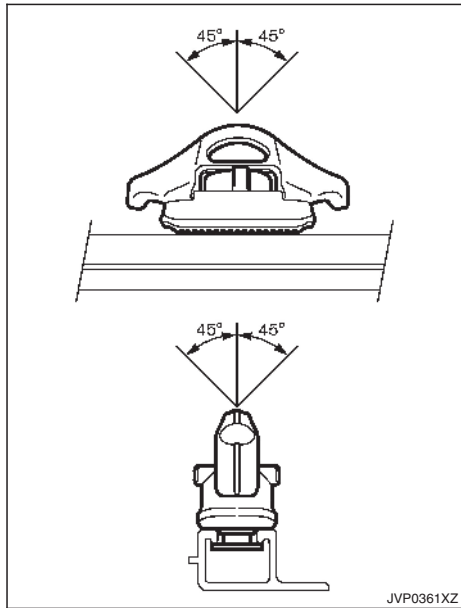

CAUTION

Install only one cleat per section of channel.

Applying loads at angles to the cleats that are greater than 45° or loads greater than 90 kg (200 lb) may cause damage to the channel or the bed.

MIRRORS



WARNING

Adjust the position of all mirrors before driving. Do not adjust the mirror positions while driving so that full attention may be given to vehicle operation.

INSIDE REARVIEW MIRROR

While holding the inside rearview mirror, adjust the mirror angles until the desired position is achieved.

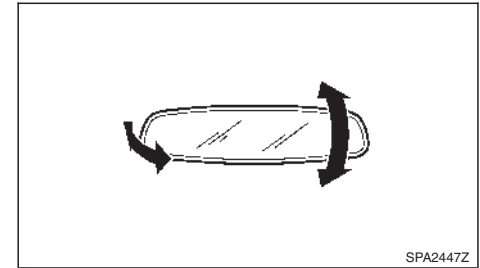

Manual anti-glare type

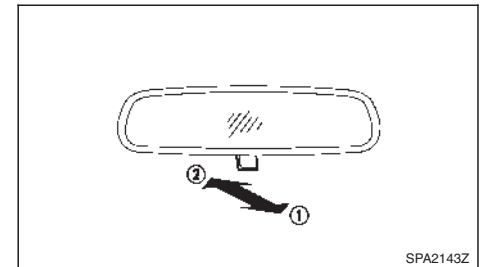

Pull the adjusting lever ① when the glare from the headlights of the vehicle behind you obstructs your vision at night.

Push the adjusting lever ② during the day for the best rearward visibility.

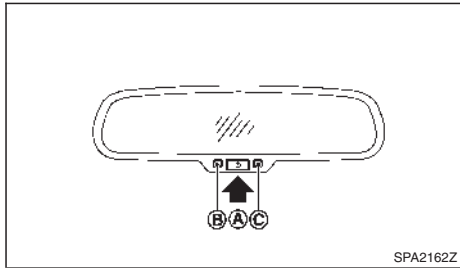

Automatic anti-glare type



The inside rearview mirror is designed so that it automatically changes reflection according to the intensity of the headlights of the vehicle following you.

The anti-glare system will be automatically turned on when you push the ignition switch to the **ON** position.

When the system is turned on, the indicator light ② will illuminate and excessive glare from the headlights of the vehicle behind you will be reduced.

Push the  switch ① for 3 seconds to make the inside rearview mirror operate normally and the indicator light will turn off. Push the  switch again for 3 seconds to turn the system on.

Do not hang any objects on the mirror or apply glass cleaner. Doing so will reduce the sensitivity of the sensor ③, resulting in improper operation.

Automatic anti-glare type with Reversing Camera (where fitted)

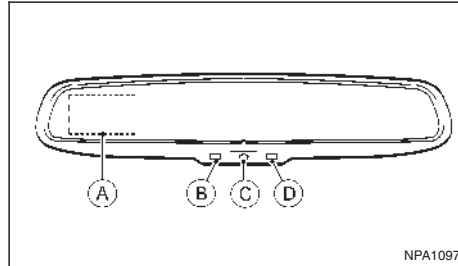

For further details about the reversing camera ①, see "Reversing Camera (where fitted)" in the "4. Display screen, heater and air conditioner, and audio system" section.

The inside rearview mirror is designed so that it automatically changes reflection according to the intensity of the headlights of the vehicle following you.

The anti-glare system will be automatically turned on when you push the ignition switch to the **ON** position.

When the system is turned on, the indicator light ② will illuminate and excessive glare from the headlights of the vehicle behind you will be reduced.

Push the  button ③ to turn the system on or off

Do not hang any objects on the mirror or apply glass cleaner. Doing so will reduce the sensitivity of the sensor ③, resulting in improper operation.

OUTSIDE REARVIEW MIRRORS



WARNING

Never touch the outside rearview mirrors while they are in motion. Doing so may pinch your fingers or damage the mirror.

Never drive the vehicle with the outside rearview mirrors folded. This reduces rear view visibility and may lead to an accident.

Objects viewed in the outside mirror are closer than they appear (where fitted).

The picture dimensions and distance in the outside mirrors are not real.

Adjusting

Remote control type:

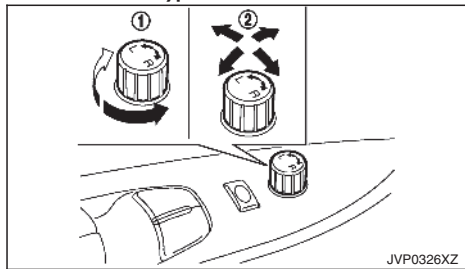

The outside rearview mirror remote control operates when the ignition switch is in the **ACC** or **ON** position.

1. Turn the switch to select the left **<L>** or right **<R>** mirror ①.

2. Adjust each mirror by pushing the switch until the desired position is achieved ②.

Defogging (where fitted)

The outside rearview mirrors will be heated when the rear window defogger switch is operated.

Folding

Manual type:

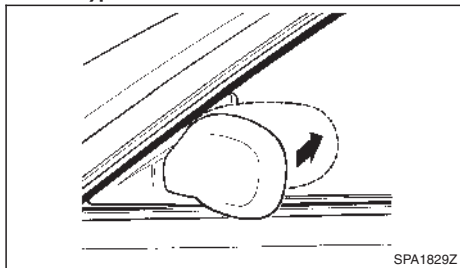

Fold the outside rearview mirror by pushing it toward the rear of the vehicle.

Remote control type:

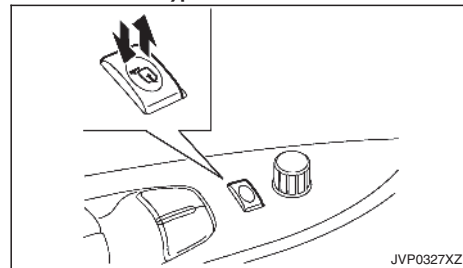

The outside rearview mirror remote control operates when the ignition switch is in the **ACC** or **ON** position.

The outside rearview mirrors automatically fold when the outside rearview mirror folding switch is pushed in. To unfold, push to the switch again.

CAUTION

Continuously performing the fold/unfold operation of the outside rearview mirror may cause the switch to stop the operation.

PARKING BRAKE

VANITY MIRROR (where fitted)

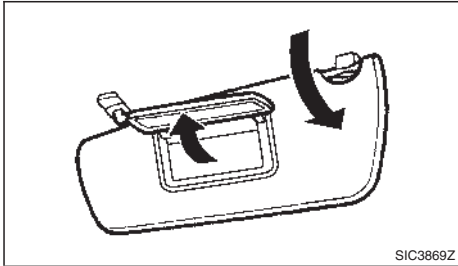

To use the front vanity mirror, pull down the sun visor and pull up the cover.



WARNING

Never drive the vehicle with the parking brake applied. The brake will overheat and fail to operate and will lead to an accident.

Never release the parking brake from outside the vehicle. If the vehicle moves, it will be impossible to push the brake pedal and will lead to an accident.

Never use the shift lever in place of the parking brake. When parking, be sure the parking brake is fully applied.

To help avoid risk of injury or death through unintended operation of the vehicle and/or its systems, do not leave children, people who require the assistance of others, or pets unattended in your vehicle. Additionally, the temperature inside a closed vehicle on a warm day can quickly become high enough to cause a significant risk of injury or death to people and pets.

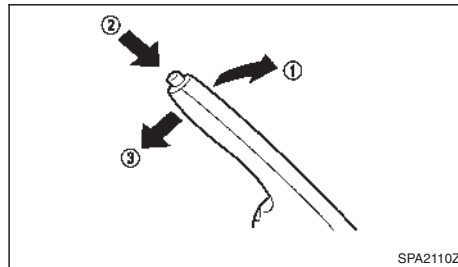

To apply the parking brake, pull the parking brake lever up ①.

To release the parking brake, depress and hold the foot brake pedal. Pull up the parking brake lever slightly, push the button ② and lower the lever completely ③.

Before driving, be sure that the brake warning light has turned off.

NOTE

4 Display screen, heater and air conditioner, and audio system

Safety precautions.....	4-2	Manual air conditioner and heater (Type A).....	4-22
Centre multi-function control panel (models with navigation system).....	4-2	Manual air conditioner and heater (Type B).....	4-24
How to use touch screen display.....	4-3	Automatic air conditioner.....	4-26
How to use brightness control/display on-off button.....	4-4	Servicing air conditioner.....	4-28
How to use <ENTER>/Scroll dial.....	4-4	Audio system (where fitted).....	4-29
How to use BACK button.....	4-4	Audio operation precautions.....	4-29
Vehicle information and settings (models with navigation system).....	4-4	Antenna.....	4-32
How to use INFO button.....	4-4	USB (Universal Serial Bus) connection port.....	4-33
How to use <SETUP> button.....	4-4	AUX (Auxiliary) input jack.....	4-33
Reversing Camera (where fitted).....	4-7	CD/USB memory care and cleaning.....	4-33
How to read the displayed lines.....	4-7	FM AM radio with compact disc (CD) player (Type A).....	4-34
Difference between predictive and actual distances.....	4-8	Audio main operation.....	4-35
How to adjust the screen.....	4-9	Radio operation.....	4-35
Operating tips.....	4-10	SETUP button.....	4-37
360° Camera (where fitted).....	4-11	Compact Disc (CD) operation.....	4-38
Operation.....	4-13	AUX (Auxiliary) socket.....	4-40
Guide lines.....	4-14	USB (Universal Serial Bus) connection port (where fitted).....	4-40
Difference between predictive and actual distances.....	4-16	iPod player operation (where fitted).....	4-41
How to adjust the screen view.....	4-18	Bluetooth® operation.....	4-42
Operating tips.....	4-18	FM-AM radio with compact disc (CD) player (Type B).....	4-48
Vents.....	4-19	Audio main operation.....	4-48
Centre vents.....	4-19	Touchscreen Navigation (where fitted).....	4-53
Side vents.....	4-19	Steering wheel switch for audio control (where fitted).....	4-54
Rear vents (where fitted).....	4-20	Audio control.....	4-54
Heater and air conditioner.....	4-20	Phone control buttons.....	4-54
Operating tips (models with automatic air conditioner).....	4-21	Bluetooth® Hands-Free Phone System (without navigation system and colour display).....	4-55
		Bluetooth® mobile phone feature.....	4-55

Hands-free telephone control	4-57
Steering wheel switches (where fitted)	4-60
Bluetooth® Hands-Free Phone System (with navigation system)	4-61
Regulatory information	4-61
Control buttons and microphone	4-62
Pairing procedure	4-62

Phonebook	4-62
Making a call	4-63
Receiving a call	4-63
During a call	4-63
Ending a call	4-63
Bluetooth® settings	4-63
Telephone setup	4-63

SAFETY PRECAUTIONS



WARNING

Do not adjust the heater and air conditioner controls or audio controls while driving so that full attention may be given to vehicle operation.

If you noticed any foreign objects entering the system hardware, spilled liquid on the system, or noticed smoke or fumes coming out from the system, or any other unusual operation is observed, stop using the system immediately and contact the nearest approved dealer or qualified workshop. Ignoring such conditions may lead to an accident, fire or electric shock.

Do not disassemble or modify this system. If you do, it may lead to an accident, fire, or electric shock.

CAUTION

Do not use the system when the engine is not running for extended periods of time to prevent battery discharge.

CENTRE MULTI-FUNCTION CONTROL PANEL (models with navigation system)

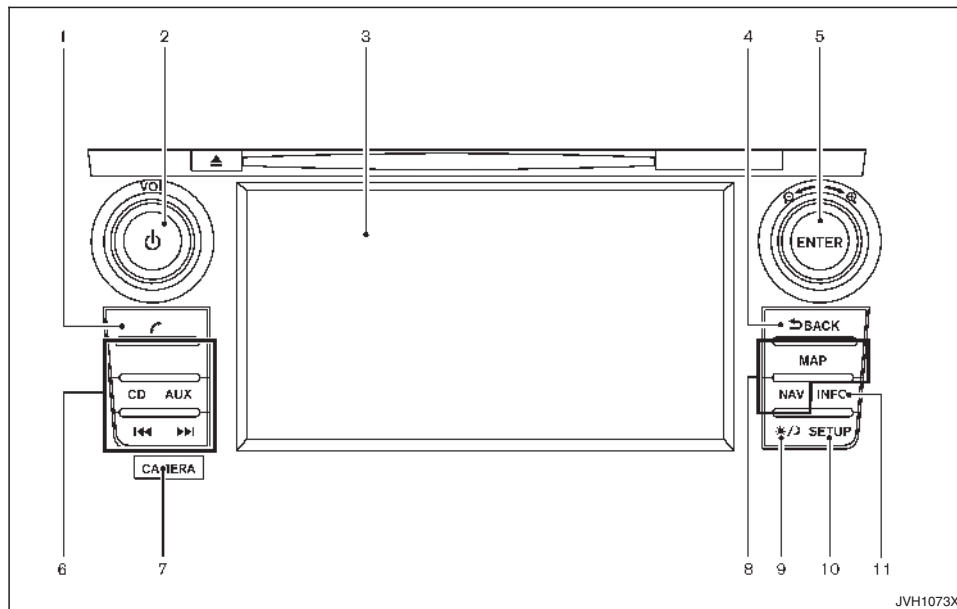

JVH1073X

1. Phone button (P. 4-61)
2. Power/VOL (volume) dial
3. Display screen (P. 4-3)
4. <BACK> button (P. 4-4)
5. <ENTER>/Scroll dial (P. 4-4)
6. Audio control buttons
7. <CAMERA> button (P. 4-7)
8. For navigation system control buttons refer to the separate Navigation System Owner's Manual.
9. Brightness control/display ON-OFF button (P. 4-4)
10. <SETUP> button (P. 4-4)
11. <INFO> button (P. 4-4)

HOW TO USE TOUCH SCREEN DISPLAY



WARNING

The glass display screen may break if it is hit with a hard or sharp object. If the glass screen breaks, do not touch it. Doing so could result in an injury.

To clean the display, never use a rough cloth, alcohol, benzine, thinner or any kind of solvent or paper towel with a chemical cleaning agent. They will scratch or deteriorate the panel.

Do not splash any liquid such as water or car fragrance on the display. Contact with liquid will cause the system to malfunction.

To help ensure safe driving, some functions cannot be operated while driving.

The on-screen functions that are not available while driving will be "greyed out" or muted.

Park the vehicle in a safe location and then operate the navigation system.

CAUTION

ALWAYS give your full attention to driving.

Avoid using vehicle features that could distract you. If distracted, you could lose control of your vehicle and cause an accident.

Touch screen operation

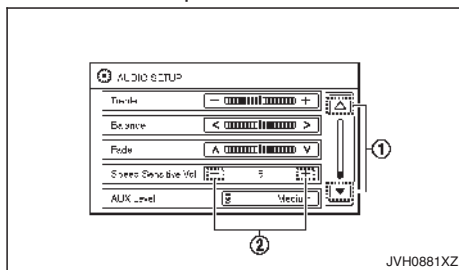

Selecting items:

Touch an item to select. For example, to select the [Treble] key, touch the [Treble] key on the screen. Touch the up or down arrows ① on the screen to display the previous or the next page.

Adjusting items:

Touch the [+] or [-] ② key to adjust the settings of an item.

Entering characters:

Touch the letter or number key on the keyboard screen. Options below are available when inputting characters.

[123/ABC]:

Changes the keyboard between numbers and letters.

[Space]:

Inserts a space.

[Delete]:

Deletes the last entered character with one touch. Touch and hold the [Delete] key to delete all of the characters.

[OK]:

Completes the character input.

Touch screen maintenance

To clean the display screen, use a dry, soft cloth. If additional cleaning is necessary, use a small amount of neutral detergent with a soft cloth. Never spray the screen with water or detergent. Dampen the cloth first and then wipe the screen.

VEHICLE INFORMATION AND SETTINGS (models with navigation system)

Vehicle information can be checked and various settings can be adjusted on the display.

NOTE

Designs and items displayed on the screen may vary depending on the models and specifications.

HOW TO USE INFO BUTTON

Push the <INFO> button to display the following menu items on the display screen.

Available items:

[Traffic Messages]

[Eco Score]

[Traffic Messages] (where fitted)

Traffic Messages can be displayed on the display screen when available. Refer to the separate Navigation System Owner's Manual for details.

[Eco Score] (where fitted)

The [Eco Score] feature analyses driving behaviour and provides an overall score. Refer to the separate Navigation System Owner's Manual for details.

HOW TO USE BRIGHTNESS CONTROL/DISPLAY ON-OFF BUTTON

Push the brightness control/display on/off <☀/🌙> button to change the display brightness between day mode and night mode. While the mode is being displayed, the brightness can be adjusted using the scroll dial.

Push and hold the brightness control/display on/off <☀/🌙> button for more than 2 seconds to turn the display off. Push the button again to turn the display on.

HOW TO USE <ENTER>/SCROLL DIAL

Turn the <ENTER>/Scroll dial to select items on the screen and to adjust the levels of setting items. Push the dial to confirm the selected item or setting.

HOW TO USE BACK BUTTON

Push the <BACK> button to return to the previous screen.

HOW TO USE <SETUP> BUTTON

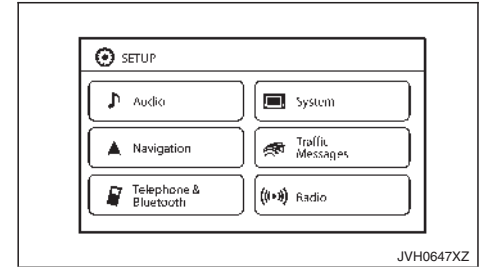

Example

Designs and items displayed on the screen may vary depending on the models and specifications.

Push the <SETUP> button to view and adjust the following setting items.

Available items:

[Audio]

[System]

- [Display]

- [Clock]

- [Language]

- [Camera Settings]

- [Temperature Unit]

- [Touch Click]

- [Beep Tones]

- [Factory Settings]

- [Software Licenses]

[Navigation]

[Telephone & Bluetooth]

[Traffic Messages]

[Radio]

[Audio] settings

Audio settings can be adjusted from the audio setup screen.

This item is available only when the audio system is turned on.

1. Push the <SETUP> button.
2. Touch the [Audio] key.
3. Select the item you wish to adjust.

[Bass]/[Treble]/[Balance]/[Fade]:

Touch the adjustment bar next to the corresponding keys on the display to adjust the tone quality and speaker balance.

The levels of these features can also be adjusted with the <ENTER>/Scroll dial.

[Speed Sensitive Vol.]:

Speed sensitive volume function increases the volume of the audio system as the speed of the vehicle increases. Choose the desired effect level from 0 (OFF) to 5. The higher the setting, the more the volume increases in relation to vehicle speed.

[AUX Level]:

This feature controls the volume level of incoming sound when an auxiliary device is connected to the system. Select the level from [Quiet], [Medium], and [Loud].

[System settings]

Various system settings can be adjusted from the system settings.

1. Push the <SETUP> button.
2. Select the [System] key.
3. Select the item you wish to adjust.

[Display]:

Select the corresponding keys to adjust the settings.

[Brightness]:

Adjusts the brightness of the display.

[Display Mode]:

Adjusts to fit the level of lighting in the vehicle. Touch the [Display Mode] key to cycle through options of the mode ([Day], [Night] and [Auto]).

[Scroll Direction]:

Adjusts the direction of the menu scroll. Choose either the up arrow or down arrow.

[Clock]:

Select the corresponding keys to adjust the settings.

[Time Format]:

The time format setting can be selected from 12 hour and 24 hour formats.

[Date Format]:

The day, month and year display can be selected from five formats.

[Clock Mode]:

Select the clock mode from [Manual], [Time Zone] and [Auto].

When [Manual] is selected, you can set the clock mode manually with the [Set Clock Manually] key.

Select [Auto] to automatically maintain the time using GPS.

[Set Clock Manually]:

Mode (AM/PM) (where fitted), Hours, Minutes, Day, Month and Year can be set manually if "Manual" is selected in the Clock Mode setting.

[Daylight Savings Time]:

Turns the daylight savings time ON or OFF.

[Time Zone]:

Select the applicable time zone from the list.

[Language]:

Select a language to be displayed on the screen.

[Camera Settings] (where fitted):

See "How to adjust the screen" later in this section for details.

[Temperature Unit]:

Select the temperature unit from °C and °F.

[Touch Click]:

Turns the touch screen click feature on or off. When turned on, a click sound will be heard every time a key on the screen is touched.

[Beep Tones]:

Turns the beep tones feature on or off. When turned on, a beep sound will be heard as a pop-up message appears on the screen.

[Factory Settings]:

Select this key to return all settings to default.

[Software Licenses] (where fitted):

Select this key to view software licence information.

[System Software Version]:

This key shows the current software version number.

[Navigation] settings

Navigation settings can be changed. See Navigation System Owner's Manual for details.

[Telephone & Bluetooth] settings

Telephone & Bluetooth settings can be changed. See "Bluetooth® Hands-Free Phone System (with navigation system)" later in this section for details.

[Traffic Messages] settings

Traffic information guidance, announcement and warning settings can be adjusted.

Traffic Announcement (TA) information can be received only in areas where the service is available.

[Radio] settings**[RDS Reg]:**

RDS messages can be turned ON or OFF. When this item is turned ON, the received RDS information will be shown on the audio screen.

RDS information can be received only in areas where the service is available.

[Traffic Announcement]:

Traffic Announcement (TA) related messages can be turned ON or OFF. When this item is turned ON, the received traffic announcement information will be tuned to automatically when received.

Traffic Announcement (TA) information can be received only in areas where the service is available.

REVERSING CAMERA (where fitted)

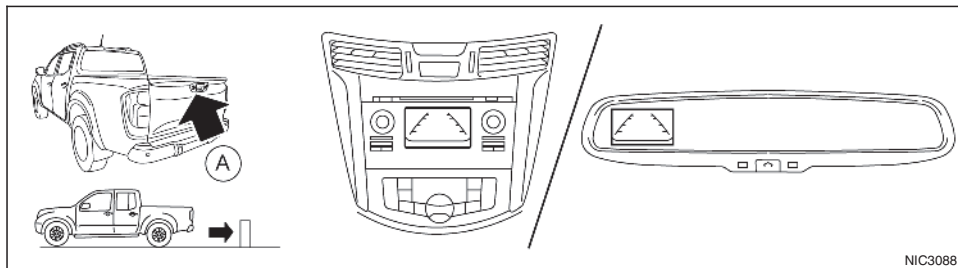

Reversing Camera displays

Ⓐ Camera

When the shift lever is shifted into the R (Reverse) position, the monitor display shows the view to the rear of the vehicle.

The system is designed as an aid to the driver in detecting large stationary objects to help avoid damaging the vehicle. The system will not detect small objects below the bumper and may not detect objects close to the bumper or on the ground.



WARNING

Failure to follow the warnings and instructions for proper use of the reversing camera could result in serious injury or death.

The reversing camera is a convenience but it is not a substitute for proper reversing. Always turn and look out the windows, and check mirrors to be sure that it is safe to move before operating the vehicle. Always reverse slowly.

The system is designed as an aid to the driver in showing large stationary objects directly behind the vehicle, to help avoid damaging the vehicle.

The system cannot completely eliminate blind spots and may not show every object.

Underneath the bumper and the corner areas of the bumper cannot be viewed on the reversing camera because of its monitoring range limitation. The system will not show small objects below the bumper, and may not show objects close to the bumper or on the ground.

Objects viewed in the reversing camera differ from actual distance because a wide-angle lens is used.

Objects in the reversing camera will appear visually opposite than when viewed in the rear view and outside mirrors

Make sure that the tailgate is securely closed when reversing.

Do not put anything on the reversing camera. The reversing camera is installed at the top of the tailgate.

When washing the vehicle with high pressure water, be sure not to spray it around the camera. Otherwise, water may enter the camera unit causing water condensation on the lens, a malfunction, fire or an electric shock.

Do not strike the camera. It is a precision instrument. Otherwise, it may malfunction or cause damage resulting in a fire or an electric shock.

CAUTION

Do not scratch the camera lens when cleaning dirt or snow from the lens.

HOW TO READ THE DISPLAYED LINES

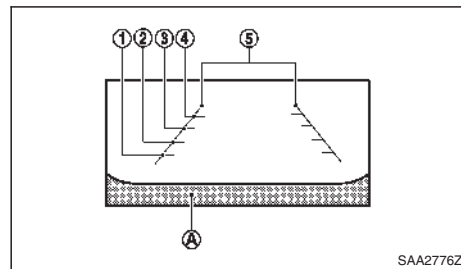

Guiding lines which indicate the vehicle width and distances to objects with reference to the bumper line Ⓐ are displayed on the monitor.

Distance guide lines:

Indicate distances from the vehicle body.

Red line ①: approx. 0.5 m (1.5 ft)

Yellow line ②: approx. 1 m (3 ft)

Green line ③: approx. 2 m (7 ft)

Green line ④: approx. 3 m (10 ft)

Vehicle width guide lines ⑤:

Indicate the vehicle width when reversing.

Setting the guide lines (where fitted)

When the reversing camera is displayed, you can switch the vehicle width guide lines and distance guide lines on/off by pushing the <CAMERA> button.

DIFFERENCE BETWEEN PREDICTIVE AND ACTUAL DISTANCES

The distance guide line and the vehicle width guide line should be used as a reference only when the vehicle is on a level, paved surface. The distance viewed on the monitor is for reference only and may be different than the actual distance between the vehicle and displayed objects.

Reversing on a steep uphill

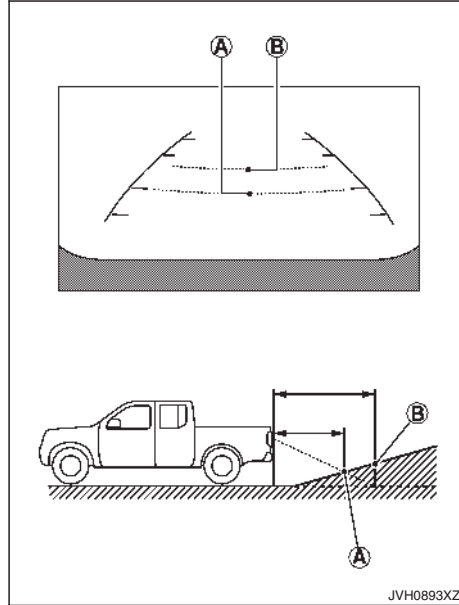

When reversing the vehicle up a hill, the distance guide lines and the vehicle width guide lines are shown closer than the actual distance. For example, the display shows 1 m (3 ft) to the place A, but the actual 1 m (3 ft) distance on the hill is the place B. Note that any object on the hill is viewed in the monitor further than it appears.

Reversing on a steep downhill

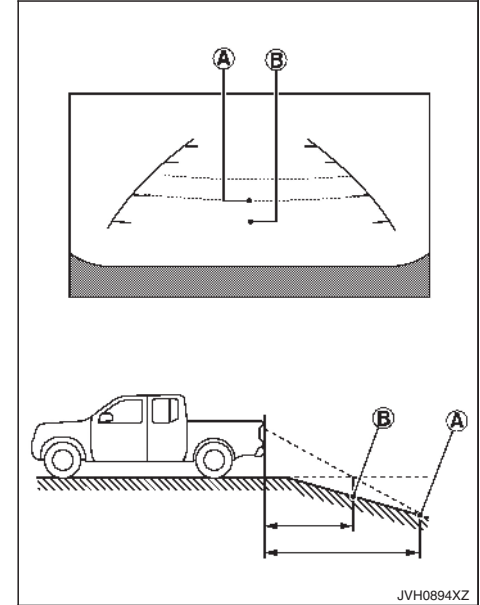

When reversing the vehicle down a hill, the distance guide lines and the vehicle width guide lines are shown further than the actual distance. For example, the display shows 1 m (3 ft) to the place A, but the actual 1 m (3 ft) distance on the hill is the place B. Note that any object on the hill is viewed in the monitor closer than it appears.

Reversing near a projecting object

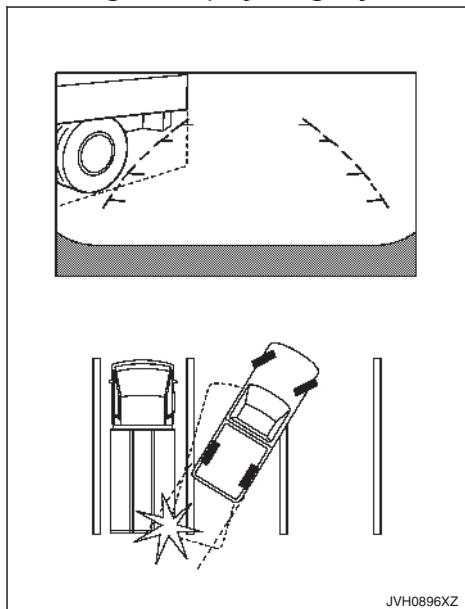

The vehicle may seem to nearly clear the object in the display. However, the vehicle may hit the object if it projects over the actual reversing course.

Reversing behind a projecting object

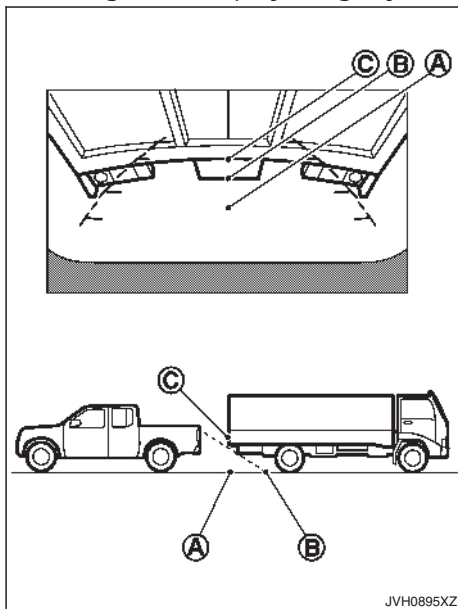

The position ③ is shown further than the position ② in the display. However, the position ③ is actually at the same distance as the position ①. The vehicle may hit the object when reversing to the position ① if the object projects over the actual reversing course.

HOW TO ADJUST THE SCREEN

Adjusting screen (for models with navigation system)

1. Push the <SETUP> button.
2. Select the [System] key.
3. Select the [Camera Settings] key.
4. Select the item you wish to adjust.

[Display Mode]:

Adjusts to fit the level of lighting in the vehicle. Touch the [Display Mode] key to cycle through options of the mode ([Day], [Night] and [Auto]).

[Brightness]:

Adjusts the brightness of the display.

[Contrast]:

Adjusts the level of contrast.

[Colour]:

Adjusts the level of the colour.

When [Brightness], [Contrast], or [Colour] are selected the system will change to the camera view to modify the settings using the <ENTER>/Scroll dial.

Adjusting screen (for models without navigation system)

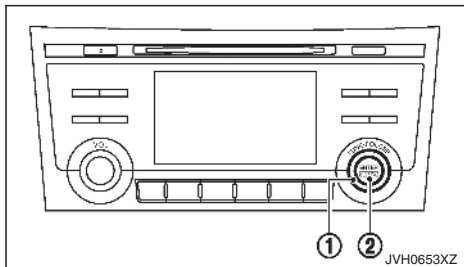

1. Push the <ENTER/SETTING> button ②.
2. Turn the <TUNE-FOLDER> dial ① to highlight the [Brightness] or the [Contrast] key.
3. Push the <ENTER/SETTING> button ②.
4. Adjust the level using the <TUNE-FOLDER> dial ① and then push the <ENTER/SETTING> button ② to apply the adjustment.

NOTE

Do not adjust the Brightness or Contrast of the reversing camera while the vehicle is moving.

OPERATING TIPS

When the shift lever is shifted to the R (Reverse) position, the monitor screen automatically changes to the reversing camera mode. However, the radio can be heard.

It may take some time until the reversing camera or the normal screen is displayed after the shift lever has been shifted to R (Reverse) from another position or to another position from R (Reverse). Objects may be distorted momentarily until the reversing camera screen is displayed completely.

When the temperature is extremely high or low, the screen may not clearly display objects. This is not a malfunction.

When strong light directly enters the camera, objects may not be displayed clearly. This is not a malfunction.

Vertical lines may be seen in objects on the screen. This is due to strong reflected light from the bumper. This is not a malfunction.

The screen may flicker under fluorescent light. This is not a malfunction.

The colours of objects displayed by the reversing camera may differ somewhat from those of the actual object.

Objects on the monitor may not be clear in a dark place or at night. This is not a malfunction.

If dirt, rain or snow attaches to the camera, the reversing camera may not clearly display objects. Clean the camera.

Do not use alcohol, benzine or thinner to clean the camera. This will cause discoloration. To clean the camera, wipe with a cloth dampened with diluted mild cleaning agent and then wipe with a dry cloth.

Do not damage the camera as the monitor screen may be adversely affected.

Do not use wax on the camera window. Wipe off any wax with a clean cloth dampened with mild detergent diluted with water.

360° CAMERA (where fitted)

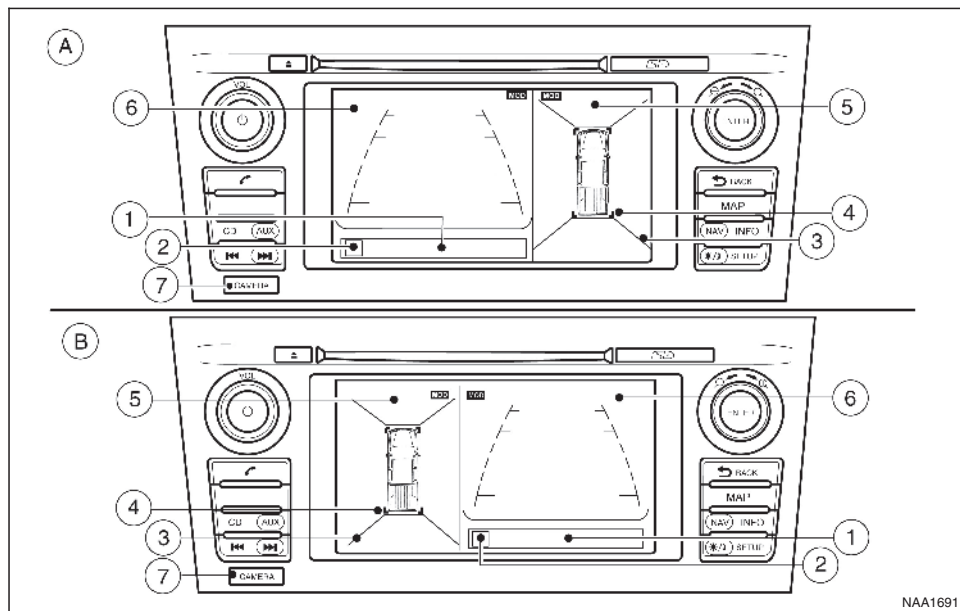

- Ⓐ Left Hand Drive
- Ⓑ Right Hand Drive
- ① Warning message
- ② Front or rear view indicator
- ③ Bird's-eye view corner lines
- ④ Bird's-eye view corner indication
- ⑤ Bird's-eye view or front-side view

- ⑥ Front or rear view
- ⑦ <CAMERA> button

With the ignition switch in the ON position, push the <CAMERA> button or move the shift lever to the R (Reverse) position to operate the 360° Camera. The monitor displays various views of the position of the vehicle.

NOTE

At first operation, the corner lines are blinking yellow for about 3 seconds. This is not a malfunction but a reminder to be cautious.

Available views:

Bird's-eye View

The surrounding view of the vehicle.

Front-side View

The view around and ahead of the front passenger's side wheel.

Front view

The view to the front of the vehicle.

Rear view

The view to the rear of the vehicle.

The system is designed as an aid to the driver in situations such as slot parking or parallel parking.

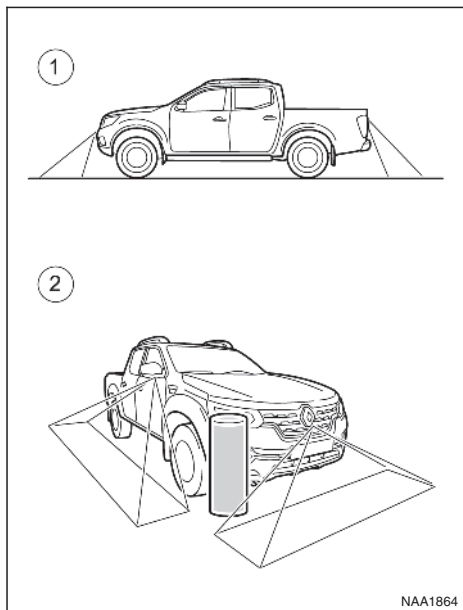

WARNING

The 360° Camera is intended for day time use. Do not use the system in bad light conditions.

The 360° Camera is a convenience feature. It is not a substitute for proper vehicle operation because it has areas where objects cannot be viewed. The four corners of the vehicle in particular, are blind spots where objects do not appear in the bird's-eye, front or rear views. Always look out the windows and check to be sure that it is safe to move. The driver is always responsible for safety during parking and other manoeuvres.

Do not use the 360° Camera with the outside mirror in the stored position, and make sure that the tailgate is securely closed when operating the vehicle using the 360° Camera.

The distance between objects viewed on the 360° Camera differs from the actual distance.

The cameras are installed on the front grille, the outside mirrors and above the rear number plate. Do not put anything on the cameras.

When washing the vehicle with high-pressure water, be sure not to spray it around the cameras. Otherwise, water may enter the camera unit causing water condensation on the lens, a malfunction, fire or an electric shock.

Do not strike the cameras. They are precision instruments. Doing so could cause a malfunction or cause damage resulting in a fire or an electric shock.

CAUTION

Do not scratch the lens when cleaning dirt or snow from the front of the camera.

NOTE

The colour of the view on the 360° Camera display is different from the actual view because the system uses infrared cameras.

There are some areas where the system will not show objects. When in the front or the rear view display, an object below the bumper or on the ground may not be viewed ①. When in the bird's-eye view, a tall object near the seam of the camera viewing areas will not appear in the monitor ②.

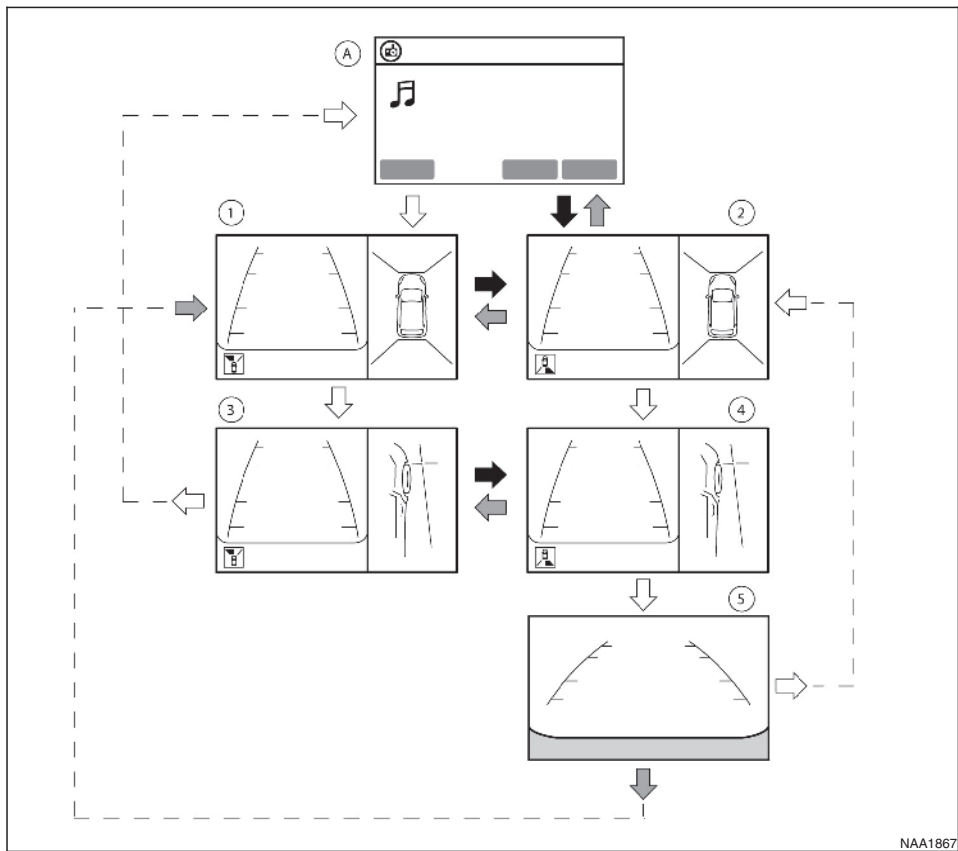

Example for Left-Hand Drive (LHD) models, for the Right-Hand Drive (RHD) models, the screen layout will be opposite.

OPERATION

The 360° Camera display consists of the front, left, right and rear screens. You can see a combination of different views on the screens as illustrated.

Ⓐ: Audio or navigation screen before the 360° Camera is operated.

①: Front view and bird's-eye view

②: Rear view and bird's-eye view

③: Front view and front side view

④: Rear view and front side view

➡: Shift lever into R (Reverse)

⚡: Shift lever out of R (Reverse)

➡: Push the <CAMERA> button

There are two ways to start using the 360° Camera:

- Select R (Reverse) gear
- Push the <CAMERA> button

Starting with the shift lever operation

When the shift lever is shifted into the R (Reverse) position the 360° Camera starts automatically and the rear view and bird's-eye view are displayed ②.

When the shift lever is shifted out of the R (Reverse) position Ⓐ, the monitor changes from the 360° Camera screen to the audio or navigation screen.

In R (Reverse) gear, the rear view and bird's-eye view ② are shown. The passenger's side view on the monitor changes to the front side view ④ when the <CAMERA> button is pushed.

Push the <CAMERA> button again change to Rear View ⑤. When the shift lever is shifted out of the R (Reverse), the screen changes to before reversing screen.

Push the <CAMERA> button from ⑤ to change back to rear view and bird's-eye view ②.

Starting with the CAMERA button operation

When the <CAMERA> button is pushed, the 360° Camera operates and the front view and bird's-eye view are displayed ①.

The front view and bird's-eye view are displayed ①. When the <CAMERA> button is pushed again ③, the view on the screen on the passenger's side changes to the front-side view. Pushing the <CAMERA> button again turns the 360° Camera off.

To change the driver's side screen between front view and rear view use the shift lever.

When the shift lever is not in the R (Reverse) position and the vehicle speed increases above approximately 10 km/h (6 MPH), the monitor changes from 360° Camera screen to the audio or navigation screen.

GUIDE LINES



WARNING

The distance guide line and the vehicle width line should be used as a reference only when the vehicle is on a paved, level surface. The distance viewed on the monitor is for reference only and may be different than the actual distance between the vehicle and displayed objects.

Use the displayed lines and the bird's-eye view as a reference. The lines and the bird's-eye view are greatly affected by the number of occupants, fuel level, vehicle position, road condition and road grade.

If the tyres are replaced with different sized tyres, the predictive course line and the bird's-eye view may be displayed incorrectly.

When driving the vehicle up a hill, objects viewed in the monitor are further than they appear. When driving the vehicle down a hill, objects viewed in the monitor are closer than they appear. Use the mirrors or actually look to properly judge distances to other objects.

The vehicle width and predictive course lines are wider than the actual width and course.

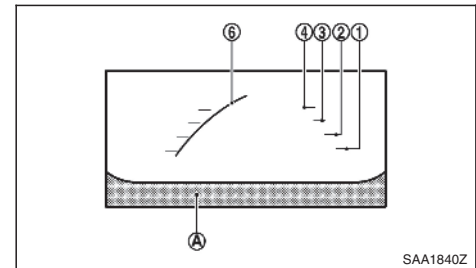

Front view

SAA1840Z

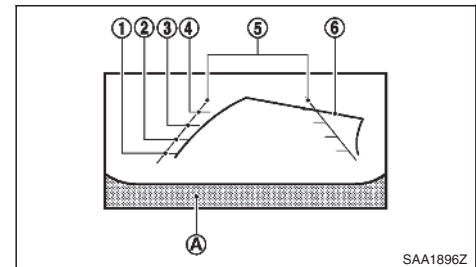

Rear view

SAA1896Z

Front and rear view

Guiding lines, which indicate the vehicle width and distances to objects with reference to the vehicle body line A, are displayed on the monitor.

Distance guide lines:

Indicate distances from the vehicle body.

Red line ①: approx. 0.5 m (1.5 ft)

Yellow line ②: approx. 1 m (3 ft)

Green line ③: approx. 2 m (7 ft)

Green line ④: approx. 3 m (10 ft)

Vehicle width guide lines and static predictive course lines ⑤:

Indicate the vehicle width when reversing.

Dynamic predictive course lines ⑥:

The dynamic predictive course lines will be displayed on the monitor when the steering wheel is turned. The course lines will move depending on how much the steering wheel is turned and will not be displayed while the steering wheel is in the neutral position.

The front view will not be displayed when the vehicle speed is above 10 km/h (6 MPH).



WARNING

The distance between objects viewed in the rear view differs from actual distance because a wide-angle lens is used. Objects in the rear view will appear visually opposite than when viewed in the rear view and outside mirrors.

On a snow-covered or slippery road, there may be a difference between the predictive course line and the actual course line.

The displayed lines on the rear view will appear slightly off to the right because the rear view camera is not installed in the rear centre of the vehicle.

NOTE

When the monitor displays the front view and the steering wheel turns about 90 degrees or less from the neutral position, both the right and left predictive course lines ⑥ are displayed. When the steering wheel turns about 90 degrees or more, a line is displayed only on the opposite side of the turn.

Bird's-eye view



WARNING

Objects in the bird's-eye view will appear further than the actual distance because the bird's-eye view is a pseudo view that is processed by combining the views from the cameras on the outside mirrors, the front and the rear of the vehicle.

Tall objects, such as a kerb or a vehicle, may be misaligned or not displayed at the seam of the views.

Objects that are above the camera cannot be displayed.

The view for the bird's-eye view may be misaligned when the camera position alters.

A line on the ground may be misaligned and is not seen as being straight at the seam of the views. The misalignment will increase as the line proceeds away from the vehicle.

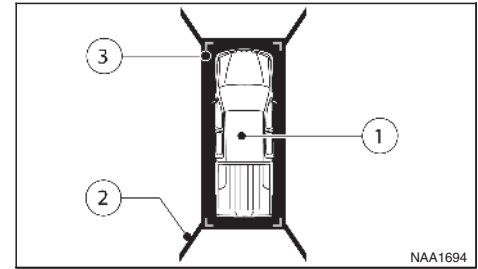

The bird's-eye view shows the overhead view of the vehicle, which helps confirm the vehicle position and the predicted course to a parking space.

The vehicle icon ① shows the position of the vehicle.

NOTE

The size of the vehicle icon on the bird's-eye view may differ somewhat from the actual vehicle.

At first operation, the blind spot corner lines ② on all four corners of the vehicle icon are blinking yellow for about 3 seconds. The four corners ③ of the vehicle are displayed in red.

NOTE

The areas that the cameras cannot cover are indicated in black.

Blind spot corner lines ② blink (yellow) on all four corners of the vehicle icon as a reminder to be cautious. This is not a malfunction.

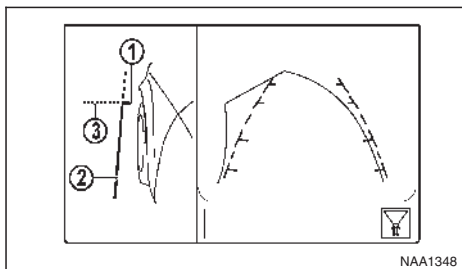

Front-side view, Left-Hand Drive (LHD) models*

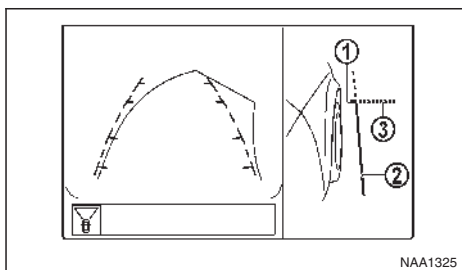

Front-side view, Left-Hand Drive (LHD) models*

The front-of-vehicle line ① shows the front part of the vehicle.

The side-of-vehicle line ② shows the vehicle width including the outside mirror.

The extensions ③ of both the front ① and side ② lines are shown with a green dotted line.

DIFFERENCE BETWEEN PREDICTIVE AND ACTUAL DISTANCES



WARNING

The distance guide line and the vehicle width guide line on the front and the rear view should be used as a reference only when the vehicle is on a level, paved surface. The distance viewed on the monitor is for reference only and may be different than the actual distance between the vehicle and displayed objects.

Reversing on a steep uphill

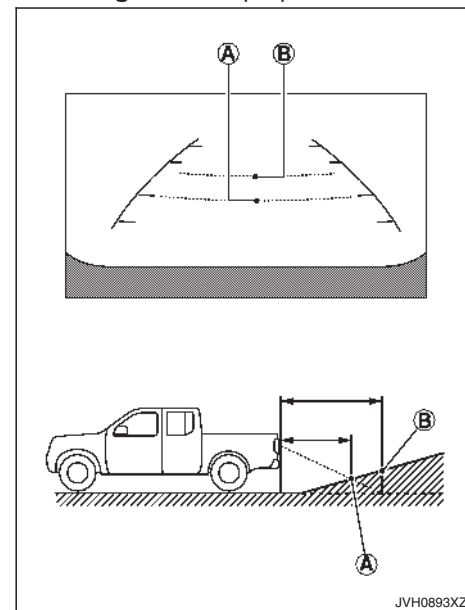

Front-side view

*: For the Right-Hand Drive (RHD) models, the screen layout will be shown opposite.

Guiding lines:

CAUTION

The actual distance to objects may differ from the distance shown.

Guiding lines that indicate the width and the front end of the vehicle are displayed on the monitor.

When moving the vehicle up a hill, the distance guide lines and the vehicle width guide lines are shown closer than the actual distance. For example, the display shows 1 m (3 ft) to the place ①, but the actual 1 m (3 ft) distance on the hill is the place ②. Note that any object on the hill is viewed in the monitor further than it appears.

Reversing on a steep downhill

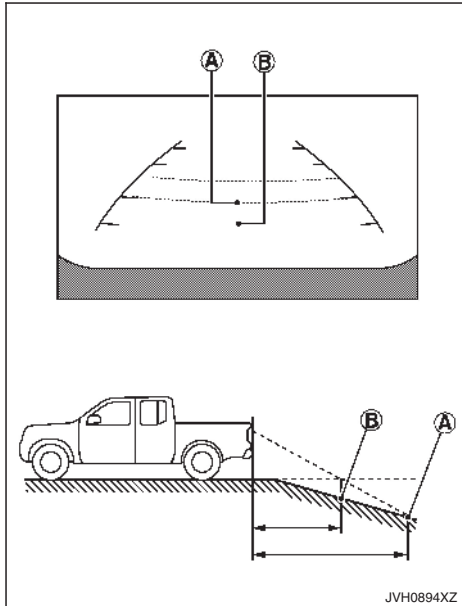

When moving the vehicle down a hill, the distance guide lines and the vehicle width guide lines are shown further than the actual distance. For example, the display shows 1 m (3 ft) to the place (A), but the actual 1 m (3 ft) distance on the hill is the place (B). Note that any object on the hill is viewed in the monitor closer than it appears.

Reversing near a projecting object

The dynamic predictive course lines (A) may show that the vehicle is not touching the object. However, the vehicle may hit the object if it projects over the actual moving course.



WARNING

The distance viewed on the monitor is for reference only and may be different than the actual distance between the vehicle and displayed objects.

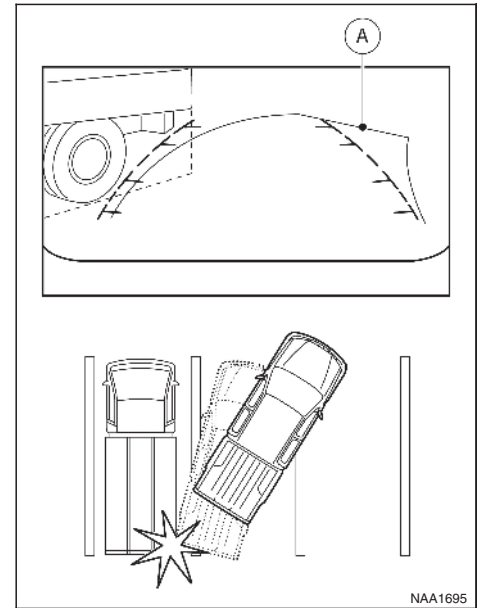

The predictive course lines (A) do not touch the object in the display. However, the vehicle may hit the object if it projects over the actual moving course.

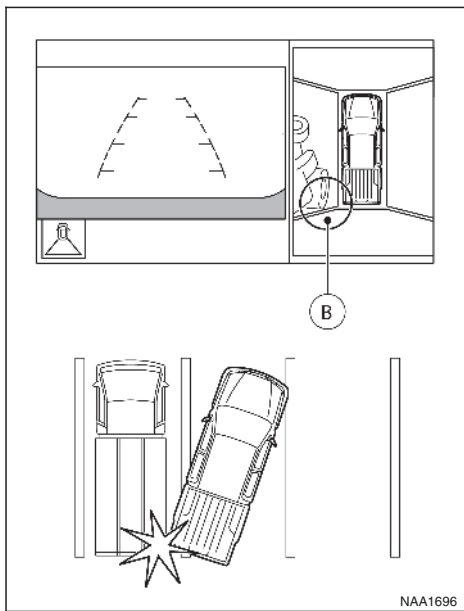

There may be a small visible distance between the vehicle and the object in the bird's-eye view (B) on the monitor.

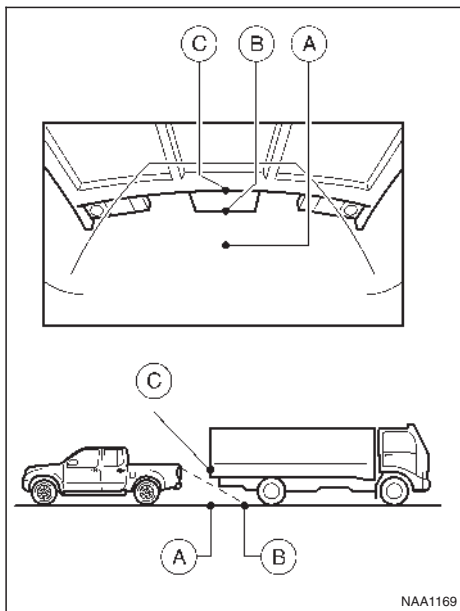

Moving closer to a projecting object

The position (C) is shown further than the position (B) in the display. However, the position (C) is actually at the same distance as the position (A). The vehicle may hit the object when moving toward the position (A) if the object projects over the actual moving course.

HOW TO ADJUST THE SCREEN VIEW

To adjust the display brightness of the 360° Camera, use the settings described in the separately provided Touchscreen Navigation owner's manual.

Do not adjust the settings while the vehicle is moving. Make sure the handbrake is firmly applied.

OPERATING TIPS

The screen displayed on the 360° Camera will automatically return to the previous screen 3 minutes after the <CAMERA> button has been pushed while the shift lever is in a position other than the R (Reverse) position.

When the view is switched, the display images on the screen may be displayed with some delay.

When the temperature is extremely high or low, the screen may not display objects clearly. This is not a malfunction.

When strong light shines directly on to the camera, objects may not be displayed clearly. This is not a malfunction.

The screen may flicker under fluorescent light. This is not a malfunction.

The colours of objects on the 360° Camera display may differ somewhat from the actual colour of objects. This is not a malfunction.

Objects on the monitor may not be clear and the colour of the object may differ in a dark environment. This is not a malfunction.

There may be differences in sharpness between each camera view of the bird's-eye view.

VENTS

If dirt, rain or snow accumulates on the camera, the 360° Camera may not display objects clearly. Clean the camera.

Do not use alcohol, benzine or thinner to clean the camera. This will cause discoloration. To clean the camera, wipe with a cloth that has been dampened with a diluted mild cleaning agent and then wipe with a dry cloth.



Do not damage the camera because the monitor screen may be adversely affected.

Do not use wax on the camera lens. Wipe off any wax with a clean cloth that has been dampened with a mild detergent diluted with water.

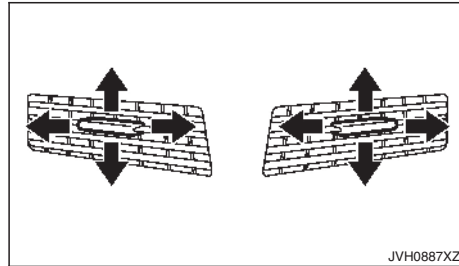
CENTRE VENTS



Adjust the air flow direction of the vents by moving the centre knob (up/down, left/right) until the desired position is achieved.

-  : This symbol indicates that the vents are closed. Moving the control to this direction will close the vents.
-  : This symbol indicates that the vents are open. Moving the control to this direction will open the vents.

SIDE VENTS

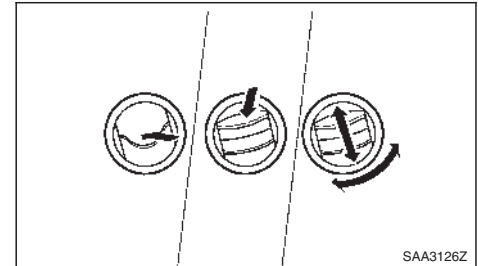

Adjust the air flow direction of the vents by opening, closing or rotating.



The side vents can be used for the side defogger.

HEATER AND AIR CONDITIONER

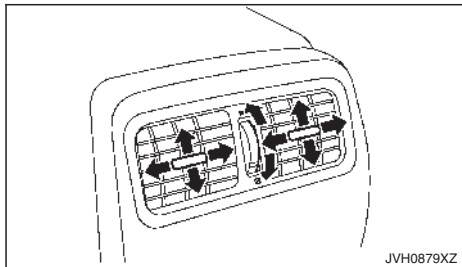
REAR VENTS (where fitted)



Open/close the vents by moving the control to either direction.

-  : This symbol indicates that the vents are closed. Moving the control to this direction will close the vents.
-  : This symbol indicates that the vents are open. Moving the control to this direction will open the vents.

Adjust the air flow direction of the vents by moving the centre knob (up/down, left/right) until the desired position is achieved.



WARNING

The heater and air conditioner operate only when the engine is running.

Never leave children or adults who would normally require the support of others alone in the vehicle. Pets should not be left alone either. They could unknowingly activate switches or controls, or move the vehicle, and inadvertently become involved in a serious accident and injure themselves. On hot, sunny days, temperatures in a closed vehicle could quickly become high enough to cause severe or possibly fatal injuries to people or animals.

Do not use the recirculation mode for long periods as it may cause the interior air to become stale and the windows to fog up.

Do not adjust the heating and air conditioning controls while driving so that full attention may be given to vehicle operation.

The heater and air conditioner operate when the engine is running. The air blower will operate even if the engine is turned off and the ignition switch is placed in the **ON** position.

NOTE

Condensation forms inside the air conditioning unit when the air conditioner (where fitted) is running, and is safely discharged underneath your vehicle.

Traces of water on the ground are therefore normal.

Odours from inside and outside the vehicle can build up in the air conditioner unit. Odour can enter the passenger compartment through the vents.

When parking, set the heater and air conditioner controls to turn off air recirculation to allow fresh air into the passenger compartment. This should help reduce odours inside the vehicle.

OPERATING TIPS (models with automatic air conditioner)

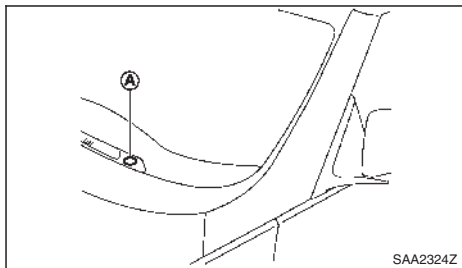

The sensors (A) and (B), located on the instrument panel, help maintain a constant temperature. Do not put anything on or around the sensors.

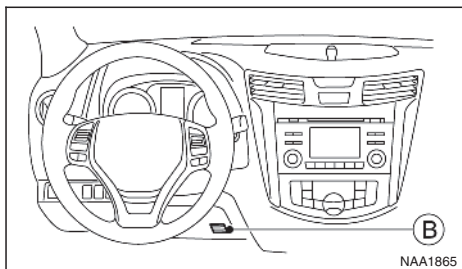

When the engine coolant temperature and outside air temperature are low, the air flow from the foot outlets may not operate. However, this is not a malfunction. After the coolant temperature warms up, the air flow from the foot outlets will operate normally.

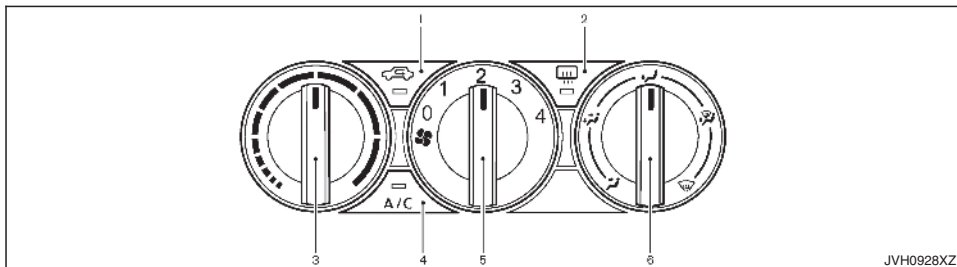

MANUAL AIR CONDITIONER AND HEATER (Type A)

1. Air recirculation button
2. Rear defogger button (See "Defogger switch (where fitted)" in the "2. Instruments and controls" section.) (where fitted)
3. Temperature control dial
4. **A/C** (air conditioner) button
5. Fan speed control dial
6. Air flow control dial

Controls

Turning system on/off:

To turn on the system, turn the fan speed control dial out of the <0> position. Turn the dial counter clockwise to the <0> position to turn off the system.

Fan speed control:

Turn the fan speed control dial clockwise to increase the fan speed.

Turn the fan speed control dial anticlockwise to decrease the fan speed.

Temperature control:

Turn the temperature control dial to set the desired temperature. Turn the dial between the middle and the right position to select the hot temperature. Turn the dial between the middle and the left position to select the cool temperature.

Air flow control:

This dial allows you to select the air flow outlets.

—	Air flows from centre and side vents.
—	Air flows from centre and side vents and foot outlets.
—	Air flows mainly from the foot outlets.
—	Air flows from the defogger and foot outlets.
—	Air flows mainly from the defogger outlets.

Outside air circulation:

Push the air recirculation button. (The indicator light will turn off.) The air flow is drawn from outside the vehicle.

Select the outside air circulation mode for normal heating or air conditioning operation.

Air recirculation:

Push the air recirculation button. (The indicator light will illuminate.)

The air flow is recirculated inside the vehicle.



A/C (Air Conditioner) operation:

Push the **A/C** button to turn on or off the air conditioner. When the air conditioner is on, the **A/C** indicator light on the button illuminates.

Heater operation



Heating:

This mode is used to direct heated air from the foot outlets.

1. Push the air recirculation  button for normal heating. (The indicator light will turn off.)
2. Turn the air flow control dial to the  position.
3. Turn the fan speed control  dial to the desired position.
4. Turn the temperature control dial to the desired position between the middle and the hot (right) position.



Ventilation:

This mode directs outside air from the side and centre vents.

1. Push the air recirculation  button. (The indicator light will turn off.)
2. Turn the air flow control dial to the  position.
3. Turn the fan speed control  dial to the desired position.
4. Turn the temperature control dial to the desired position.

Defrosting or defogging:

This mode directs the air to the defogger outlets to defrost/defog the windows.

1. Turn the air flow control dial to the  position.
2. Push the air recirculation  button. (The indicator light will turn off.)
3. Turn the fan speed control  dial to the desired position.



4. Turn the temperature control dial to the desired position between the middle and the hot (right) position.

To remove frost from the windscreen quickly, turn the temperature control dial to the maximum position and the fan speed control  dial to the maximum position.

If it is difficult to defog the windscreen, turn the **A/C** button on.



Bi-level heating:

This mode directs cool air from the side and centre vents and warm air from the foot outlets. When the temperature control dial is turned to the maximum hot or cool position, the air between the vents and the foot outlets is the same temperature.

1. Push the air recirculation  button. (The indicator light will turn off.)
2. Turn the air flow control dial to the  position.
3. Turn the fan speed control  dial to the desired position.
4. Turn the temperature control dial to the desired position.

Heating and defogging:

This mode heats the interior and defogs the windows.



1. Push the air recirculation  button. (The indicator light will turn off.)
2. Turn the air flow control dial to the  position.
3. Turn the fan speed control dial to the desired position.
4. Turn the temperature control dial to the maximum hot (right) position.

Air conditioner operation



The air conditioner system should be operated for approximately 10 minutes at least once a month. This helps prevent damage to the air conditioner system due to the lack of lubrication.

Cooling:

This mode is used to cool and dehumidify the air.



1. Push the air recirculation  button. (The indicator light will turn off.)
2. Turn the air flow control dial to the  position.
3. Turn the fan speed control dial to the desired position.
4. Push the **A/C** button on. (The **A/C** indicator light will illuminate.)
5. Turn the temperature control dial to the desired position between the middle and the cool (left) position.

A visible mist may be seen coming from the vents in hot, humid conditions as the air is cooled rapidly. This does not indicate a malfunction.

For quick cooling when the outside temperature is high, push the air recirculation  button. (The indicator light will turn on.) Be sure to return the air recirculation  button to turn off for normal cooling.



Dehumidified heating:

This mode is used to heat and dehumidify the air.

1. Push the air recirculation  button. (The indicator light will turn off.)
2. Turn the air flow control dial to the  position.
3. Turn the fan speed control  dial to the desired position.
4. Push the **A/C** button on. (The **A/C** indicator light will illuminate.)
5. Turn the temperature control dial to the desired position between the middle and the hot (right) position.



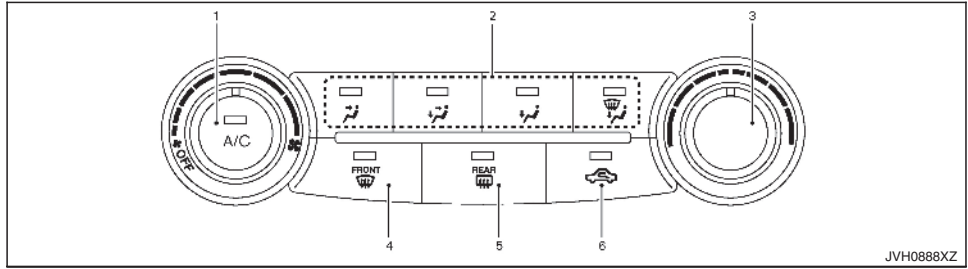

Dehumidified defogging:

This mode is used to defog the windows and dehumidify the air.

1. Push the air recirculation  button. (The indicator light will turn off.)
2. Turn the air flow control dial to the  position.
3. Turn the fan speed control  dial to the desired position.
4. Push the **A/C** button on. (The **A/C** indicator light will illuminate.)
5. Turn the temperature control dial to the desired position.



MANUAL AIR CONDITIONER AND HEATER (Type B)

1. **A/C** button/Fan speed control  dial
2. Air flow control buttons
3. Temperature control dial
4. Front defogger  button
5. Rear defogger  button (See "Defogger switch (where fitted)" in the "2. Instruments and controls" section.) (where fitted)
6. Air recirculation  button

Controls

Turning system on/off:

To turn on the system, turn the fan speed control  dial out of the **<OFF>** position. Turn the dial anticlockwise to the **<OFF>** position to turn off the system.



Fan speed control:

Turn the fan speed control  dial clockwise to increase the fan speed.

Turn the fan speed control  dial anticlockwise to decrease the fan speed.

Ventilation:

This mode directs outside air from the side and centre vents.





1. Push the air recirculation  button. (The indicator light will turn off.)
2. Push the  button. (The indicator light will turn on.)
3. Turn the fan speed control  dial to the desired position.
4. Turn the temperature control dial to the desired position.

Temperature control:

Turn the temperature control dial to set the desired temperature. Turn the dial between the middle and the right position to select the hot temperature. Turn the dial between the middle and the left position to select the cool temperature.

Air flow control:

Push one of the air flow control buttons to select the air flow outlets.

	—	Air flows mainly from centre and side vents.
	—	Air flows mainly from centre and side vents and foot outlets.
	—	Air flows mainly from the foot outlet and partly from the defogger.
	—	Air flows mainly from the defogger and foot outlets.

Outside air circulation:

Push the air recirculation  button. (The indicator light will turn off.) The air flow is drawn from outside the vehicle.

Select the outside air circulation mode for normal heating or air conditioning operation.

Air recirculation:

Push the air recirculation  button on. (The indicator light will illuminate.)

The air will recirculate inside the vehicle.



A/C (Air Conditioner) operation:

Push the A/C button to turn on or off the air conditioner. When the air conditioner is on, the A/C indicator light on the button illuminates.

Heater operation



Heating:

This mode is used to direct heated air from the foot outlets.

1. Push the air recirculation  button for normal heating. (The indicator light will turn off.)
2. Push the  button. (The indicator light will turn on.)
3. Turn the fan speed control  dial to the desired position.
4. Turn the temperature control dial to the desired position between the middle and the hot (right) position.

Defrosting or defogging:

This mode directs the air to the defogger outlets to defrost/defog the windows.



1. Turn the fan speed control  dial to the desired position.
2. Push the front defogger  button. (The indicator lights on the front defogger  button and the A/C button will turn on.) Then the air recirculation indicator light will turn off.
3. Turn the temperature control dial to the desired position between the middle and the hot (right) position.

To remove frost from the windscreen quickly, turn the temperature control dial to the maximum hot (right) position and the fan speed control  dial to the maximum position. For the best bi-

level heating performance, do not select the air recirculation mode. For the best defogging performance, do not select the air recirculation mode.



Bi-level heating:

This mode directs cool air from the side/centre vents and warm air from the foot outlets. (When the temperature control dial is turned to the maximum hot (right) or cool (left) position, the temperatures from the side/centre vents and the foot outlets will be the same.)

1. Push the air recirculation  button. (The indicator light will turn off.)
2. Push the  button. (The indicator light will turn on.)
3. Turn the fan speed control  dial to the desired position.
4. Turn the temperature control dial to the desired position.

Heating and defogging:

This mode heats the interior and defogs the windows.



1. Push the air recirculation  button. (The indicator light will turn off.)
2. Push the  button. (The indicator light will turn on.)
3. Turn the fan speed control  dial to the desired position.
4. Turn the temperature control dial to the maximum hot (right) position.

Air conditioner operation



The air conditioner system should be operated for approximately 10 minutes at least once a month. This helps prevent damage to the air conditioner system due to the lack of lubrication.

Cooling:

This mode is used to cool and dehumidify the air.



1. Push the air recirculation  button. (The indicator light will turn off.)
2. Push the  button. (The indicator light will turn on.)
3. Turn the fan speed control  dial to the desired position.
4. Push the **A/C** button. (The indicator light will turn on.)
5. Turn the temperature control dial to the desired position between the middle and the cool (left) position.

A visible mist may be seen coming from the vents in hot, humid conditions as the air is cooled rapidly. This does not indicate a malfunction.

For quick cooling when the outside temperature is high, push the air recirculation  button. (The indicator light will turn on.) Be sure to return the air recirculation  button to turn off for normal cooling.



Dehumidified heating:

This mode is used to heat and dehumidify the air.

1. Push the air recirculation  button. (The indicator light will turn off.)
2. Push the  button. (The indicator light will turn on.)
3. Turn the fan speed control  dial to the desired position.
4. Push the **A/C** button. (The indicator light will turn on.)
5. Turn the temperature control dial to the desired position between the middle and the hot (right) position.

Dehumidified defogging:

This mode is used to defog the windows and dehumidify the air.

1. Push the front defogger  button. (The indicator lights on the front defogger  button and the **A/C** button will turn on.) Then the air recirculation indicator light will turn off.
2. Turn the fan speed control  dial to the desired position.
3. Turn the temperature control dial to the desired position.

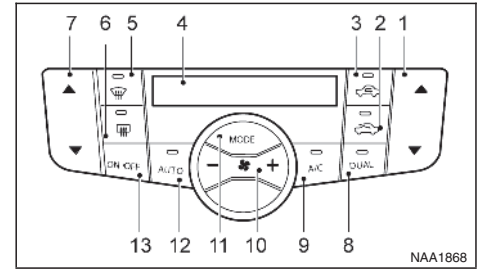



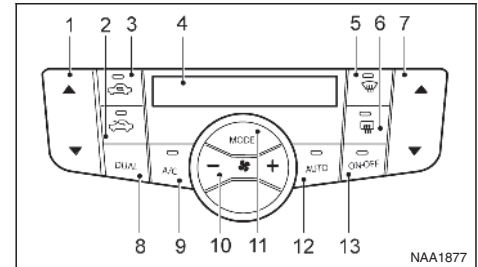

Left hand drive



Right hand drive

AUTOMATIC AIR CONDITIONER

1. Temperature control buttons
2. Outside air circulation  button
3. Air recirculation  button
4. Display screen
5. Front defogger  button



6. Rear defogger  button (See "Defogger switch (where fitted)" in the "2. Instruments and controls" section.)
7. Temperature control buttons
8. <DUAL> (zone control ON/OFF) button
9. **A/C** (Air Conditioner) button
10. Fan speed control  button
11. <MODE> button
12. <AUTO> button
13. <ON-OFF> button



Automatic operation (AUTO)

The <AUTO> mode may be used year-round as the system automatically controls the air conditioner to a constant temperature, air flow distribution and fan speed after the desired temperature is set manually.



To turn the heater and air conditioner on or off, push the <ON-OFF> button.

Cooling and dehumidified heating:

1. Push the <AUTO> button (the <AUTO> indicator light will illuminate).
2. If the **A/C** indicator light is not illuminated, push the **A/C** button (the **A/C** indicator light will illuminate).
3. Push the temperature control buttons ( and ) to set the desired temperature.



When the <DUAL> indicator light is not illuminated, pushing the <DUAL> button (the <DUAL> indicator light will illuminate) allows the user to independently change the driver and passenger side temperatures with the corresponding temperature control buttons ( and ).

To cancel the separate temperature setting, push the <DUAL> button (the <DUAL> indicator light will turn off) and the driver's side temperature setting will be applied to both the driver and passenger sides.



4. Push either the outside air circulation  button or the air recirculation  button (the button with an indicator light illuminated) for approximately 2 seconds to switch to the automatic air intake control mode (the indicator light will blink twice).

A visible mist may be seen coming from the vents in hot, humid conditions as the air is cooled rapidly. This does not indicate a malfunction.

Heating (A/C off):

1. Push the <AUTO> button (the <AUTO> indicator light will illuminate).
2. If the **A/C** indicator light is illuminated, push the **A/C** button (the **A/C** indicator light will turn off).
3. Push the temperature control buttons ( and ) to set the desired temperature.

When the <DUAL> indicator light is not illuminated, pushing the <DUAL> button (the <DUAL> indicator light will illuminate) allows the user to independently change the driver





and passenger side temperatures with the corresponding temperature control buttons ( and ).

To cancel the separate temperature setting, push the <DUAL> button (the <DUAL> indicator light will turn off) and the driver's side temperature setting will be applied to both the driver and passenger sides.

Do not set the temperature lower than the outside air temperature. Doing so may cause the temperature to not be controlled properly.

If the windows fog up, use dehumidified heating instead of the **A/C** off heating.

Dehumidified defrosting/defogging:

1. Push the front defogger  button (the  indicator light will illuminate).
2. Push the temperature control buttons ( and ) to set the desired temperature.

To quickly remove frost from the outside surface of the windscreen, set the temperature control and the fan speed to the maximum levels.

After the windscreen is cleared, push the <AUTO> button to return to the <AUTO> mode.

When the front defogger  button is pushed, the air conditioner will automatically turn on, sensing the outside air temperature to defog the windscreen. For the best defogging performance, do not select the air recirculation mode.

Do not set the temperature too low when the front defogger mode is on (the  indicator light is illuminated), because doing so may fog up the windscreen.

Manual operation





The manual mode can be used to control the heater and air conditioner to your desired settings.

Fan speed control:



Push the fan speed control  button (+ side or - side) to manually control the fan speed.



Air flow control:

Push the <MODE> button to select the desired mode:

 _	Air flows from the centre and side vents.
 _	Air flows from the centre and side vents and foot outlets.
 _	Air flows mainly from the foot outlets
 _	Air flows from the front defogger outlets and foot outlets.

Temperature control:

Push the temperature control buttons ( and ) to set the desired temperature.



When the <DUAL> indicator light is not illuminated, pushing the <DUAL> button (the <DUAL> indicator light will illuminate) allows the user to independently change the driver and passenger side temperatures with the corresponding temperature control buttons ( and ).

To cancel the separate temperature setting, push the <DUAL> button (the <DUAL> indicator light will turn off) and the driver's side temperature setting will be applied to both the driver and passenger sides.







Outside air circulation:

Push the outside air circulation button to draw the air flow from outside the vehicle. (The  indicator light will illuminate.)

Air recirculation:

Push the air recirculation  button to circulate the air flow inside the vehicle. (The  indicator light will illuminate.)

Automatic air intake control:

Push either the outside air circulation  or the air recirculation  button (the button with an indicator light illuminated) for approximately 2 seconds. The  or  indicator light will blink twice, and the air intake will then be controlled automatically. When the automatic control is set, the system automatically alternates between the outside air circulation  and the air recirculation  modes (the indicator light of the active mode will illuminate).

To turn system on/off

To turn off the heater and air conditioner, push the <ON-OFF> button.

SERVICING AIR CONDITIONER



WARNING

The air conditioner system contains refrigerant under high pressure. To avoid personal injury, any air conditioner service should be done only by an experienced technician with the proper equipment.

The air conditioner system in your vehicle is charged with a refrigerant designed with the environment in mind.



This refrigerant will not harm the earth's ozone layer. However, it may contribute in a small part to global warming.

Special charging equipment and lubricant are required when servicing your vehicle's air conditioner. Using improper refrigerants or lubricants will cause severe damage to the air conditioner system. (See "Recommended fluids/lubricants and capacities" in the "9. Technical information" section.)

An approved dealer or qualified workshop will be able to service your environmentally friendly air conditioner system.

Air conditioner filter

The air conditioner system is equipped with an air conditioner filter which collects and neutralises dirt, pollen, dust, etc. To make sure that the air conditioner heats, defogs and ventilates efficiently, replace the filter in accordance with the specified maintenance intervals listed in the separate maintenance booklet. To replace the filter, contact an approved dealer or qualified workshop.

The filter should be replaced if the air flow decreases significantly or if windows fog up easily when operating the heater or air conditioner.

AUDIO SYSTEM (where fitted)

AUDIO OPERATION PRECAUTIONS



WARNING

Do not adjust the audio system while driving so that full attention may be given to vehicle operation.

Radio

Radio reception is affected by station signal strength, distance from radio transmitter, buildings, bridges, mountains and other external influences. Intermittent changes in reception quality normally are caused by these external influences.

Using a mobile phone in or near the vehicle may influence radio reception quality.

Compact Disc (CD) player

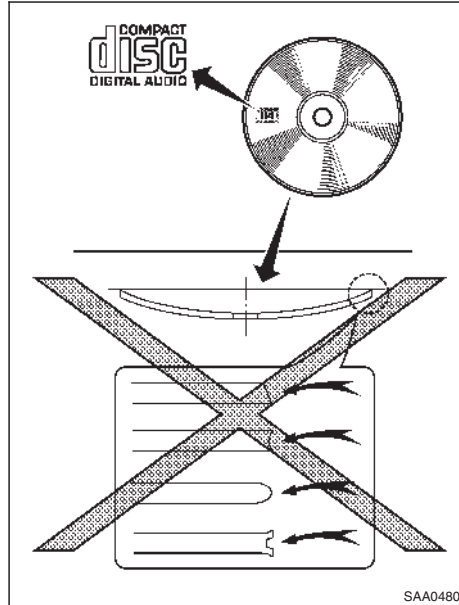

During cold weather or rainy days, the player may malfunction due to the humidity. If this occurs, remove the CD from CD player and dehumidify or ventilate the player completely.

The player may skip while driving on rough roads.

The CD player sometimes may not function when the passenger compartment temperature is extremely high. Lower the temperature before use.

Do not expose the CD to direct sunlight.

CDs that are of poor quality, or are dirty, scratched, covered with fingerprints, or that have pin holes may not work properly.

The following CDs may not work properly.

- Copy control compact discs (CCCD)
- Recordable compact discs (CD-R)
- Rewritable compact discs (CD-RW)

Do not use the following CDs as they may cause the CD player to malfunction.

- 8 cm (3.1 in) discs
- CDs that are not round
- CDs with a paper label
- CDs that are warped, scratched or have unusual edges.

This audio system can only play prerecorded CDs. It has no capabilities to record or burn CDs.

USB (Universal Serial Bus) Connection Port



WARNING

Do not connect, disconnect or operate the USB device while driving. Doing so can be a distraction. If distracted you could lose control of your vehicle and cause an accident or serious injury.

CAUTION

Do not force the USB device into the USB port. Inserting the USB device tilted or up-side-down into the port may damage the port. Make sure that the USB device is connected correctly into the USB port.

Do not grab the USB port cover (where fitted) when pulling the USB device out of the port. This could damage the port and the cover.

Do not leave the USB cable in a place where it can be pulled unintentionally. Pulling the cable may damage the port.

The vehicle is not equipped with a USB device. USB devices should be purchased separately as necessary.

This system cannot be used to format USB devices. To format a USB device, use a personal computer.

In some areas, the USB device for the front seats plays only sound without images for regulatory reasons, even when the vehicle is parked.

This system supports various USB memory devices, USB hard drives and iPod players. Some USB devices may not be supported by this system.

Partitioned USB devices may not play correctly.

Some characters used in other languages (Chinese, Japanese, etc.) may not appear properly in the display. Using English language characters with a USB device is recommended.

General notes for USB use:

Refer to your device manufacturer's owner information regarding the proper use and care of the device.

Notes for iPod use:

iPod is a trademark of Apple Inc., registered in the U.S. and other countries.

Improperly plugging in the iPod may cause a checkmark to be displayed on and off (flickering). Always make sure that the iPod is connected properly.

An iPod nano (1st Generation) may remain in fast forward or rewind mode if it is connected during a seek operation. In this case, please manually reset the iPod.

An iPod nano (2nd Generation) will continue to fast-forward or rewind if it is disconnected during a seek operation.

An incorrect song title may appear when the Play Mode is changed while using an iPod nano (2nd Generation).

Audiobooks may not play in the same order as they appear on an iPod.

Large video files cause slow responses in an iPod. The vehicle centre display may momentarily black out, but will soon recover.

If an iPod automatically selects large video files while in the shuffle mode, the vehicle centre display may momentarily black out, but will soon recover.

Bluetooth® audio player (where fitted)

Some Bluetooth® audio devices may not be used with this system. For detailed information about Bluetooth® audio devices that are available for use with this system, contact an approved dealer or qualified workshop.

Before using a Bluetooth® audio system, the initial registration process for the audio device is necessary.

Operation of the Bluetooth® audio system may vary depending on the audio device that is connected. Confirm the operation procedure before use.

The playback of Bluetooth® audio will be paused under the following conditions. The playback will be resumed after the following conditions are completed.

- while using a hands-free phone
- while checking a connection with a mobile phone

The in-vehicle antenna for Bluetooth® communication is built in the system. Do not place the Bluetooth® audio device in an area surrounded by metal, far away from the system or in a narrow space where the device closely contacts the body or the seat. Otherwise, sound degradation or connection interference may occur.

While a Bluetooth® audio device is connected through the Bluetooth® wireless connection, the battery power of the device may discharge quicker than usual.

This system is compatible with the Bluetooth® AV profile (A2DP and AVRCP).



Bluetooth® is a trademark owned by Bluetooth SIG, Inc., and licensed to Visteon Corporation and Robert Bosch GmbH.

Compact Disc (CD)/USB device with MP3/WMA/AAC (where fitted)

Terms:

MP3 — MP3 is short for Moving Pictures Experts Group Audio Layer 3. MP3 is the most well known compressed digital audio file format. This format allows for near “CD quality” sound, but at a fraction of the size of normal audio files. MP3 conversion of an audio track from CD can reduce the file size by approximately 10:1 ratio (Sampling: 44.1 kHz, Bit rate: 128 kbps) with virtually no perceptible loss in quality. MP3 compression removes the redundant and irrelevant parts of a sound signal that the human ear doesn’t hear.

WMA — Windows Media Audio (WMA) is a compressed audio format created by Microsoft as an alternative to MP3. The WMA codec offers greater file compression than the MP3 codec, enabling storage of more digital audio tracks in the same amount of space when compared to MP3s at the same level of quality.

AAC (where fitted) — Advanced Audio Coding (AAC) is a compressed audio format. AAC offers greater file compression than MP3 and enables music file creation and storage at the same quality as MP3.

Bit rate — Bit rate denotes the number of bits per second used by a digital music files. The size and quality of a compressed digital audio file is determined by the bit rate used when encoding the file.

Sampling frequency — Sampling frequency is the rate at which the samples of a signal are converted from analog to digital (A/D conversion) per second.

Multisession — Multisession is one of the methods for writing data to media. Writing data once to the media is called a single session, and writing more than once is called a multisession.

ID3/WMA Tag — The ID3/WMA tag is the part of the encoded MP3 or WMA file that contains information about the digital music file such as song title, artist, album title, encoding bit rate, track time duration, etc. ID3 tag information is displayed on the Album/Artist/Track title line on the display.

- * Windows® and Windows Media® are registered trademarks and/or trademarks of Microsoft Corporation in the United States of America and/or other countries.

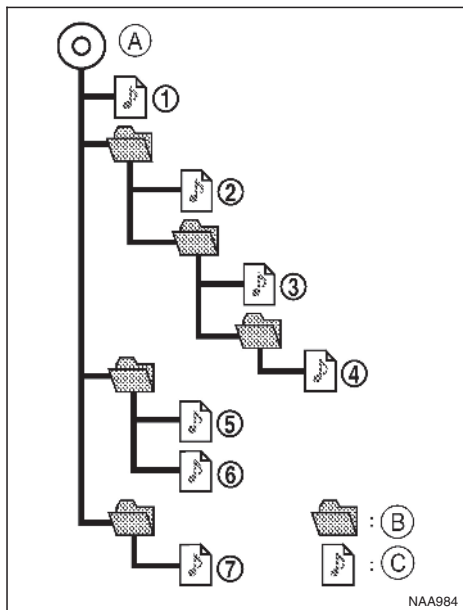

Playback order:

Music playback order of the CD with MP3/WMA/AAC (where fitted) is as illustrated above.

The folder names of folders not containing MP3/WMA files are not shown in the display.

If there is a file in the top level of the disc, FOLDER is displayed.

The playback order is the order in which the files were written by the writing software, so the files might not play in the desired order.

- (A) Root folder
- (B) Folder
- (C) MP3/WMA

ANTENNA

Roof antenna

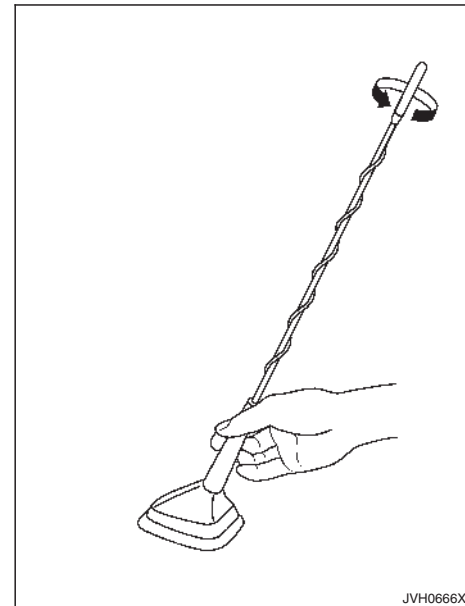

The antenna can be removed if necessary.

Hold the bottom of the antenna and remove by turning anticlockwise.

To install the antenna, turn the antenna clockwise and tighten.

CAUTION

To avoid damaging or deforming the antenna, be sure to remove the antenna under the following conditions.

- The vehicle enters an automatic car wash.
- The vehicle enters a garage with a low ceiling.
- The vehicle is covered with a car cover.

USB (Universal Serial Bus) connection port



WARNING

Do not connect, disconnect or operate the USB device while driving. Doing so can be a distraction. If distracted you could lose control of your vehicle and cause an accident or serious injury.

CAUTION

Do not force the USB device into the USB port. Inserting the USB device tilted or up-side-down into the port may damage the port. Make sure that the USB device is connected correctly into the USB port.

Do not grab the USB port cover (where fitted) when pulling the USB device out of the port. This could damage the port and the cover.

Do not leave the USB cable in a place where it can be pulled unintentionally. Pulling the cable may damage the port.

Refer to your device manufacturer's owner information regarding the proper use and care of the device.

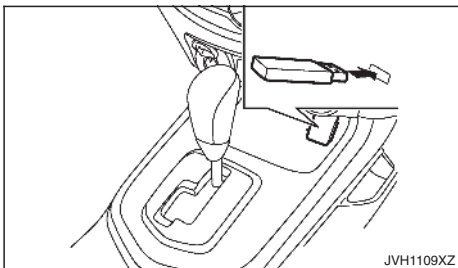

The USB port is located on the lower part of the instrument panel. Insert USB devices or iPod connectors into this port.

AUX (Auxiliary) INPUT JACK

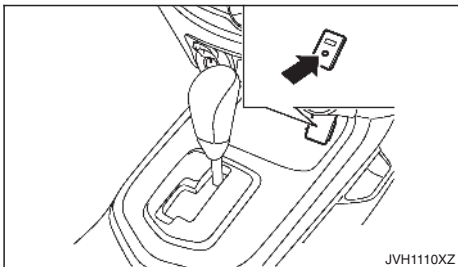

The AUX input jack is located on the lower part of the instrument panel. Compatible audio devices, such as some MP3 players, can be connected to the system through the AUX input jack.

Before connecting a device to a jack, turn off the power of the portable device.

With a compatible device connected to the jack, push the corresponding button (depends on the audio system) repeatedly until the display switches to the AUX mode.

RENAULT strongly recommends using a stereo mini plug cable when connecting your music device to the audio system. Music may not play properly when a monaural cable is used.

CD/USB MEMORY CARE AND CLEANING

CD

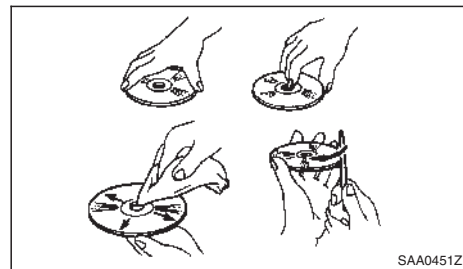

Handle a disc by its edges. Never touch the surface of the disc. Do not bend the disc.

Always place the discs in the storage case when they are not being used.

FM AM RADIO WITH COMPACT DISC (CD) PLAYER (Type A)

To clean a disc, wipe the surface from the centre to the outer edge using a clean, soft cloth. Do not wipe the disc using a circular motion.

Do not use a conventional record cleaner or alcohol intended for industrial use.

A new disc may be rough on the inner and outer edges. Remove the rough edges by rubbing the inner and outer edges with the side of a pen or pencil as illustrated.

USB memory

Do not place heavy objects on the USB memory. Do not store the USB memory in highly humid locations.

Do not expose the USB memory to direct sunlight.

Do not spill any liquids on the USB memory.

Refer to the USB memory Owner's Manual for details.

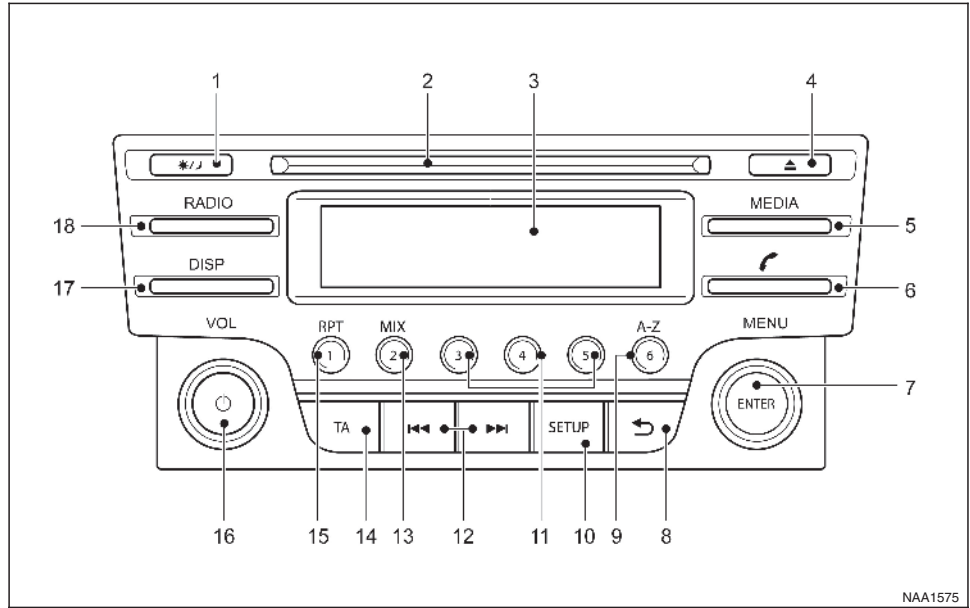

NAA1575

1. ☀/🌙 (Day/Night) button
(Display brightness (Day/Night mode) button)
Turn the MENU button to set the display brightness

The illumination brightness level is linked to the headlight switch. When the headlights are switched "ON" the brightness is dimmed automatically. Press the button to toggle illumination brightness levels between daytime setting and nighttime setting independent of headlamp status.
2. CD slot
3. Display
4. CD eject button
5. MEDIA button
Switch between the audio sources (CD, USB, AUX, BT Audio) (if connected)

6. Telephone button
7. Radio mode: TUNE dial
Audio unit mode: MENU dial
Confirmation (ENTER) button
8. Back button
9. Radio mode: Preset button
USB/MP3 CD/iPod or Phone mode: Quick search button
10. SETUP button
11. Radio mode: Preset buttons
12. Fast Forward (Cue)/Forward Track and Rewind/Previous Track buttons
13. Radio mode: Preset button
CD/iPod/USB/Bluetooth audio mode: MIX button
14. Traffic Announcement (TA) button
15. Radio mode: Preset button
CD/iPod/USB/Bluetooth audio mode: Repeat (RPT) button
16. Power ON-OFF button/Volume control (VOL) knob
17. DISP button (Display)
Provides on screen information when available (music tags, RDS, etc.)
18. RADIO button

AUDIO MAIN OPERATION

The audio unit operates when the ignition switch is in ACC or ON position.



Power ON/OFF button

Press the  button to switch on the audio unit. If the audio unit was switched off using the ignition switch, it can also be switched on with the ignition switch. The source that was playing immediately before the unit was switched off will resume playing and the volume will be set to the previous volume level.

The audio unit can be switched off by pressing , or by turning the ignition switch to the "OFF" or LOCK position.



Volume (VOL) level control

Turn the **<VOL>** dial clockwise or anticlockwise to adjust the volume level.

The audio unit is equipped with a speed control volume function, this means that the audio system automatically adjusts the volume level in relation to vehicle speed. For details, see "[Speed Volume] menu" later in this section.

RADIO OPERATION

When the  (power ON/OFF) button is pressed, the audio unit will switch on with the last received radio station, if the audio unit was previously switched off in radio mode.

The radio is able to receive multiple kinds of audio transmissions:

- FM

- DAB (Digital Audio Broadcasting) indicated as DR (where fitted)
- AM

Radio band select buttons

Press the **<RADIO>** button to change the audio transmission source as follows:

FM1 → FM2 → DR1 → DR2 → AM → FM1

When **<RADIO>** button is pressed, the radio will come on at the last received radio station. If audio is already playing using one of the other input sources (iPod, Bluetooth, CD, USB, AUX-in) pressing the **<RA-DIO>** button will switch off the playing source mode and the last received radio station will be selected.

Setting preset stations

Auto populating the [FM List]:

When the **<RADIO>** button is pressed for more than 1.5 seconds the six stations with the strongest signals are stored in the preset (1 to 6) buttons of the band. During the search, a notification message [Updating FM List] appears in the display and the sound is muted until the operation is complete. Once completed, the radio reverts to the previously selected radio station.



Manual tuning

When adjusting the broadcasting station frequency manually access the [FM List] and turn the **<MENU>** dial until the desired station is tuned in.

The frequency increases or decreases in steps of 100 kHz on the FM band, and 9 kHz on the AM band.



WARNING

The radio should not be tuned while driving in order for full attention to be given to the driving operation.



SEEK tuning buttons

FM mode:

Pressing the ►► or ◀◀ button starts the tuning mode. A short press of the button will increase or decrease the frequency a single step. Pressing the button longer will activate the seek mode. The radio tuner seeks from low to high or high to low frequencies and stops at the next broadcasting station. During seek mode, the audio output is muted. If no broadcasting station can be found within the complete band cycle, it will return to the initial frequency.

DR mode:

Press to ►► or ◀◀ select the next or previous station

Preset station buttons ①②③④⑤⑥

Pressing a preset button for less than 2 seconds will select the stored radio station.

Pressing a preset button for more than 2 seconds while in the [FM list] or radio main screen will cause the station currently being received to be stored against that preset button.

Twelve stations (if available) can be stored in the FM bands. (Six each for FM1 and FM2)

Twelve stations (if available) can be stored in the DR bands. (Six each for DR1 and DR2) (where fitted)

Six stations (if available) can be set for the AM band.

If the battery is disconnected, or if the fuse blows, the radio memory will be erased. In that case, reset the desired stations after battery connection or fuse replacement.

DAB and Radio Data System (RDS) operation (where fitted)

The RDS is a system through which encoded digital information is transmitted by FM radio stations in addition to the normal FM radio broadcasting. The RDS provides information services such as station name, traffic information, or news.

DAB (Digital Audio Broadcast)

NOTE

When in DR mode operation is similar to FM mode but may slightly differ.

In some countries or regions, some of these services may not be available.

Alternative Frequency (AF) mode:

The AF mode operates in the FM (radio) mode.

The AF mode operates in the FM (radio), AUX or CD mode (if FM was previously selected in the radio mode).

The AF function compares signal strengths and selects the station with the optimum reception conditions for the currently tuned-in station.

DAB and RDS functions

Programme Service (PS) function (station name display function):

- FM:
 - When an RDS station is tuned in with seek or manual tuning, the RDS data is received and the PS name is displayed.
- DR:
 - When a station is tuned in with seek or manual tuning, the data is received and the PS name is displayed.

TA Traffic announcement

This function operates in FM/DR (Radio) mode. This function will still operate in the background if any media source is selected (CD, USB or MEDIA mode).

Pressing the <TA> button selects the TA mode. The TA indicator is displayed while TA mode is on.

When <TA> is pressed again. The mode will be switched off and the TA indicator will disappear from the display.

Traffic announcement interrupt function:

When a traffic announcement is received, the announcement is tuned in and the display shows a notification message with the radio station name e.g. [TA: Radio 1].

Once the traffic announcement has finished, the unit returns to the source that was active before the traffic announcement started.

If **<TA>** is pressed during a traffic announcement, the traffic announcement interrupt mode is cancelled. The TA mode returns to the standby mode and the audio unit returns to the previous source.

SETUP BUTTON



To configure [Audio], [Clock], [Radio], and [Language] settings, perform the following procedure:

1. Press the **<SETUP>** button.
2. Turn the **<MENU>** dial clockwise or anticlockwise, the display will appear in the following order:

[Audio] ⇄ [Clock] ⇄ [Radio] ⇄ [Language]

After the desired levels have been set, press either the  (Back) button repeatedly, or the **<SETUP>** button.

Audio adjustments

1. Press the **<SETUP>** button to enter the setup menu screen then select [Audio].
2. Turn the **<MENU>** dial clockwise or anticlockwise, the display will appear in the following order:

[Sound] → [AUX in] → [Speed Volume] → [Bass Boost] → [Audio Default]

[Sound] menu:

Submenus in the sound menu:

- [Bass] Use this control to enhance or attenuate bass response sound. Turn the **<MENU>** dial clockwise or anticlockwise to adjust the bass settings then press **<ENTER>** to confirm.
- [Treble] Use this control to enhance or attenuate the treble. Turn the **<MENU>** dial clockwise or anticlockwise to adjust the treble settings then press **<ENTER>** to confirm.
- [Balance] Use this control to adjust the balance of the volume between the left and right speakers. Turn the **<MENU>** dial anticlockwise or clockwise to adjust the left/right balance then press **<ENTER>** to confirm.
- [Fade] Use this control to adjust the balance of the volume between the front and rear speakers. Turn the **<MENU>** dial anticlockwise or clockwise to adjust the front/rear balance then press **<ENTER>** to confirm.

[AUX in] menu:

Use this control to adjust the volume output from the auxiliary source. Turn the **<MENU>** dial anticlockwise or clockwise to select [Low], [Medium], or [High] mode then press **<ENTER>** to confirm.

[Speed Volume] menu:

This mode controls the volume output from the speakers automatically in relation to vehicle speed. When [Speed Volume] is displayed, turn the **<MENU>** dial clockwise or anticlockwise to adjust the volume level.

Adjusting the setting to 0 (zero) turns off the speed volume feature. Increasing the speed volume setting results in the audio volume increasing more rapidly with vehicle speed. Once chosen, press **<ENTER>** to save the setting.

[Bass Boost] menu:

Switch [Bass boost] [ON] or [OFF]

[Audio default] menu:

The audio unit has a saved preset settings as a factory default. Select [Yes] to change all settings back to the factory preset settings. Select [No] to exit the menu keeping the current settings.

Setting the clock

The clock menu screen set up screen will appear when selecting the [Clock] item from the set up menu.

[Set Time]:

Select [Set Time] then adjust the clock as follows:

1. The hour display will start flashing. Turn the **<MENU>** dial to adjust the hour.
2. Press the **<ENTER>** button. The minute display will start flashing.
3. Turn the **<MENU>** dial to adjust the minute.
4. Press **<ENTER>** to finish the clock adjustment.

[On/Off]:

Set the clock display between on or off when the audio unit is turned off.

If set in the [ON] position, the clock will be displayed when the audio unit is turned off either by pressing the **⏻** button or when the ignition switch is placed in the "OFF" position.

[Format]:

Set the clock display between 24-hour mode and 12-hour clock mode.

[Radio] menu

For activation or deactivation details, see "SETUP button" earlier in this section.

[TA]

Use this control to switch Traffic Announcements on or off when the unit starts.

Turn the **<MENU>** dial clockwise or anticlockwise to select then press **<ENTER>** to confirm.

[DR Inter-rupt...]

For models fitted with DAB (Digital Audio Broadcasting) functionality only.

Switch on or off specific listed Digital Interruptions. When selected the DAB radio stations will be interrupted if a specific message is available.

Turn the **<MENU>** dial clockwise or anticlockwise to adjust then press **<ENTER>** to select.

[Ref. FM List]

Manually update the FM station list

Press the **<ENTER>** to start the search of the stations. The text [Updating FM list...] appears. In a short period of time the stations are updated and the last station (if possible) starts playing.

Language settings

Select the appropriate language and press the **<ENTER>** button. Upon completion, the screen will automatically adapt the language setting.

[Chinese]

[Chinese Simplified]

[Deutsch]

[Español]

[Français]

[Korean]

[Italiano]

[Nederlands]

[Polski]

[Português]

[Türkçe]

[UK English]

[русский]

COMPACT DISC (CD) OPERATION

The CD player can play a music CD or an encoded MP3/WMA CD and while listening to those CD's music information tags (track and artist information) can be displayed (when CD encoded with text is being used).

Press the **<MEDIA>** button and the CD (if loaded) will start to play.

When **<MEDIA>** is pressed and the radio or another source mode is already operating, it will automatically turn off the playing source and the CD play mode will start.

CAUTION

Do not force the CD into the slot. This could damage the player.

Do not use 8 cm (3.1 in) discs.

CD insert (CD player)

Insert the CD disc into the slot with the label side facing up. The disc will be guided automatically into the slot and will start playing. After loading the disc, track information will be displayed.

NOTE

The CD player accepts normal audio CD or CD recorded with MP3/WMA files.

Inserting a CD recorded with MP3/WMA files, the audio unit will automatically detect and [MP3CD] will be indicated.

An error notification message will be displayed when inserting a wrong disc type (e.g. DVD), or the player cannot read the CD disc. Eject the disc and insert another disc.

MEDIA button

Load a CD disc. After a short loading period the CD starts playing.

If the disc was already loaded:

Press the <MEDIA> button (depending on other connected audio sources if necessary multiple times) to select CD. Playing starts from the track that was being played when the CD play mode was switched off.

Audio main operation



List view:

While the track is being played, either press the <ENTER> button or turn the <MENU> dial to display the available tracks in a listed view mode. To select a track from the list, or a track to start listening from, turn the <MENU> dial then press <ENTER>.

Press the  button to return to the song.







Fast Forward (Cue), Fast Reverse (Review) buttons:



When the  (Cue) or  (Review) button is pressed continuously, the track will be played at high speed. When the button is released, the track will be played at normal playing speed.



Track up/down buttons:

Pressing the  or  button once, the track will be skipped forward to the next track or backward to the beginning of the current played track. Press the  or  button more than once to skip through the tracks.

Folder browsing:

If the recorded media contains folders with music files, pressing the  or  button will play in sequence the tracks of each folder.

To select a preferred folder:

1. Press the <ENTER> button or turn the <MENU> dial and a list of tracks in the current folder is displayed.
2. Turn the <MENU> dial for the preferred folder.
3. Press <ENTER> to access the folder. Press <ENTER> again to start playing the first track or turn the <MENU> dial, and press <ENTER> to select another track.

If the current selected folder contains sub folders, press <ENTER>, a new screen with a list of sub folders will be displayed. Turn the <MENU> dial for the sub folder then press <ENTER> to select. Select the [Root] folder item when songs are recorded additionally in the root folder.

To return to the previous folder screen, press .



Repeat button:

Push the RPT  button and the current track will be played continuously.



MIX button:

Push the MIX  button and all the tracks in the current folder (MP3 CD/USB) or playlist (iPod) will be played in a random order.

When the entire folder/playlist has been played the system will start playing the next folder/playlist.



DISP button:

While a CD with recorded music information tags (CD-text/ID3-text tags) is being played, the title of the played track is displayed. If the title information is not provided then [Track] is displayed.

When the DISP  button is pressed repeatedly, further information about the track can be displayed along with the track title as follows:

CD:

Track time → Artist name → Album title → Track time

CD with MP3/WMA:

Track time → Artist name → Album title → Folder name → Track time

The track name is always displayed.

Track details:

A long press on the DISP  button will turn the display into a detailed overview and after a few seconds it returns to the main display, or press DISP  briefly.

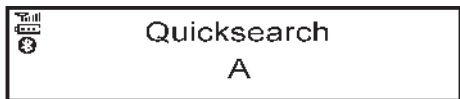

Quick search:

When a MP3 CD with recorded music information tags (ID3-text tags) is being played from list view mode, a quick search can be performed to find a track from the list.

Push the **<A-Z>**  button then turn the **<MENU>** dial for the first alphabetic/numerical letter of the track title then press **<ENTER>**. When found, a list of the available tracks will be displayed. When there is no match (the display shows [No match]) the next item will be shown. Select, and press **<ENTER>** to play the preferred track.



CD eject button

CD player:

Press the  (eject) button and the CD will be ejected.

Ejecting CD (with ignition switch in "OFF" or LOCK):

When the ignition switch is in the "OFF" or LOCK position it is possible to eject the currently played CD. However the audio unit will not be activated.

Press the  button and the CD will be ejected.

NOTE

When the CD is ejected and not removed within 8 seconds, it will automatically retract into the slot to protect it from damage.

If an error message appears in the display, press  to eject the faulty CD and insert another CD or check if the ejected CD is inserted upside down.

AUX (Auxiliary) SOCKET

Audio main operation

The AUX IN jack is located on the centre console. The AUX IN audio input jack accepts any standard analog audio input such as from a portable cassette tape/CD player, MP3 player or laptop computer. RENAULT strongly recommends using a stereo mini plug cable when connecting your music device to the audio system. Music may not play properly when a monaural cable is used.

Press the **<MEDIA>** button for the AUX mode.

Use the play mode of the device to play the audio.

USB (Universal Serial Bus) CONNECTION PORT (where fitted)

See "Audio system (where fitted)" earlier in this section for the location of the USB port. If the system has been turned off while the USB device was playing, pushing the PWR button will start the USB device.



WARNING

Do not connect, disconnect or operate the USB device while driving. Doing so can be a distraction. If distracted you could lose control of your vehicle and cause an accident or serious injury.

Connecting USB memory

Connect a USB memory stick or another USB device. The display will show the notification message [USB Detected Please Wait...] for a few seconds, while it is reading the data.

If the audio system has been turned off while the USB memory was playing, pressing  will start the USB device operation.

CAUTION

Do not force the USB device into the USB port. Inserting the USB device tilted or upside-down into the port may damage the port. Make sure that the USB device is connected correctly into the USB port.

Do not grab the USB port cover (where fitted) when pulling the USB device out of the port. This could damage the port and the cover.

Do not leave the USB cable in a place where it can be pulled unintentionally. Pulling the cable may damage the port.

Do not locate objects near the USB device to prevent the objects from leaning on the USB device and the port. Pressure from the objects may damage the USB device and the port.

The vehicle is not equipped with a USB device. USB devices should be purchased separately as necessary.

This system cannot be used to format USB devices. To format a USB device, use a personal computer.

In some areas, the USB device for the front seats plays only sound without images for regulatory reasons, even when the vehicle is parked.

This system supports various USB connection port devices, USB hard drives and iPod players. Some USB devices may not be supported by this system.

Partitioned USB devices may not play correctly.

Some characters used in other languages (Chinese, Japanese, etc.) may not appear properly in the display. Using English language characters with a USB device is recommended.

General notes for USB use:

Refer to your device manufacturer's owner information regarding the proper use and care of the device.

MEDIA button

To operate the USB device press <MEDIA> once or repeatedly until [USB] is available.

Audio main operation

The following operations are identical to the audio main operation of the Compact Disc (CD) operation. For details, see "Compact Disc (CD) operation" earlier in this section.

List view

Quick search



MIX (Random play)

RPT (Repeat track)

Folder browsing

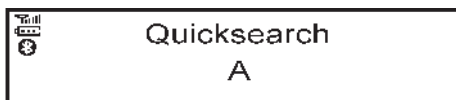

Quick search:

When a USB device with recorded music information tags (ID3-text tags) is being played from list view mode, a quick search can be performed to find a track from the list.

Push the <A-Z> ⑥ button then turn the <MENU> dial for the first alphabetic/numerical letter of the track title then press <ENTER>. When found, a list of the available tracks will be displayed. When there is no match (the display shows [No match]) the next item will be shown. Select, and press <ENTER> to play the preferred track.

DISP button ⑤

While a track with recorded music information tags (ID3-tags) is being played, the title of the played track is displayed. If the tags are not provided then a notification message is displayed.

When the **DISP** ⑤ button is pressed repeatedly, further information about the track can be displayed along with the track title as follows:

Track time → Artist name → Album title → Track time

Track details:

A long press on the **DISP** ⑤ button will turn the display into a detailed overview and after a few seconds it returns to the main display, or press **DISP** ⑤ briefly.

iPod PLAYER OPERATION (where fitted)

Connecting iPod

Open the console lid and connect the iPod cable to the USB connector. The battery of the iPod will be charged during the connection to the vehicle. The display will show the notification message [iPod <Name> Detected...] for a few seconds, while it is reading the data.

If the audio system has been turned off while the iPod was playing, pressing  will start the iPod operation. During the connection, the iPod can only be operated with the audio controls.

* iPod and iPhone are trademarks of Apple Inc., registered in the U.S. and other countries.



WARNING

Do not connect, disconnect or operate the USB device while driving. Doing so can be a distraction. If distracted you could lose control of your vehicle and cause an accident or serious injury.

CAUTION

Do not force the iPod cable into the USB port. Inserting the iPod cable tilted or upside-down into the port may damage the port. Make sure that the iPod cable is connected correctly into the USB port.

Do not locate objects near the iPod cable to prevent the objects from leaning on the iPod cable and the port. Pressure from the objects may damage the iPod cable and the port.

Refer to your device manufacturer's owners manual regarding the proper use and care of the device.

Compatibility:

NOTE

At the time of publication, this audio system was tested with the latest iPod players/iPhone available. Due to the frequent update of consumer devices like MP3 players, RENAULT cannot guarantee that all new iPod players/iPhone launched will be compatible with this audio system.

Some iPod operations may not be available with this system.

Make sure that the iPod/iPhone is updated with the latest firmware.

iPod Shuffle and iPod mini cannot be used with this system.

Full functionality of iPhone USB and Bluetooth Audio may not be available to the user if the same device is connected by USB and Bluetooth simultaneously.

MEDIA button

To operate the iPod press <MEDIA> once or repeatedly until [iPod <Name>] is shown.



Audio main operation

Interface:

The interface for iPod operation shown on the audio system display is similar to the iPod interface. Use the <MENU> dial and the <ENTER> button to play a track on the iPod.

The following items can be chosen from the menu list screen.

- [Playlists]
- [Artists]
- [Albums]
- [Tracks]
- [More...]
- [Composers]
- [Genre]
- [Podcasts]

For further information about each item, see the iPod owner's manual.

The following operations are identical to the audio main operation of the Compact Disc (CD) operation. For details, see "Compact Disc (CD) operation" earlier in this section.

List view



MIX (Random play)

RPT (Repeat track)

Folder browsing

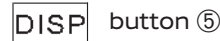

While a track with recorded music information tags (ID3-tags) is being played, the title of the played track is displayed. If the tags are not provided then a notification message is displayed.

When the **DISP** button is pressed repeatedly, further information about the track can be displayed along with the track title as follows:

Track time → Artist name → Album title → Track time

Track details:

A long press on the **DISP** button, the screen displays the song title, artist name, and album title. After a few seconds it returns to the main display or press **DISP** briefly.

BLUETOOTH® OPERATION

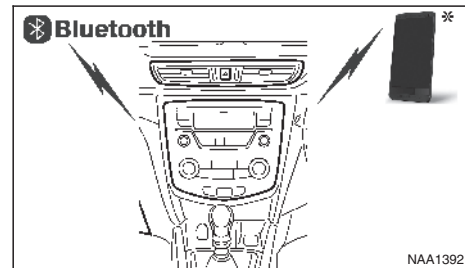

*: a device with bluetooth capabilities

Regulatory information



Bluetooth® is a trademark owned by Bluetooth SIG, Inc.

BLUETOOTH® settings

To pair a device, make sure the Bluetooth is switched on and use the [Scan device] key or the [Pair device] key. For details, see "[Scan devices]" later in this section.

Up to 5 different Bluetooth devices can be connected. However, only one device can be used at a time. If 5 different Bluetooth registered devices are registered, a new device can only replace one of the 5 existing paired devices. Use [Del. device] key to delete one of the existing paired devices. For details, see "[Pair device]" later in this section.

When successfully paired a notification message will be displayed, then the audio system display will return to the current audio source display. During connection the following status icons will be displayed (top left of the display): Signal strength (📶), Battery status* (🔋) and Bluetooth "ON" (📶).

*: If the low battery message comes on, the Bluetooth® device must be recharged soon.

The pairing procedure and operation may vary according to device type and compatibility. See the Bluetooth® owner's manual for further details.

NOTE

For device details, see your audio/mobile phone Owner's Manual.

For assistance with the Bluetooth® audio/mobile phone integration, please visit your local approved dealer or qualified workshop.

To set up the Bluetooth system with a device the following items are available:



[Scan devices]

Bluetooth devices can be paired with the system. A maximum of 5 Bluetooth devices can be registered.

[Pair device]

Bluetooth devices can be paired with the system. A maximum of 5 Bluetooth devices can be registered.

[Sel. device]

Paired Bluetooth devices are listed and can be selected for connection.

[Del. device]

A registered Bluetooth device can be deleted.

[Bluetooth]

If this setting is turned off, the connection between the Bluetooth devices and the in-vehicle Bluetooth module will be cancelled.

[Scan devices]:

- 1) Press the button. Select [Scan device]
The audio unit searches Bluetooth devices and shows all visible devices.

Make sure your Bluetooth device is visible at this time.

- 2) Select the device to be paired.
Use the <MENU> dial and press to select.

- 3) The pairing procedure may depend on the device to be connected:

- 1) Device without PIN code:

The Bluetooth connection will be automatically connected without any further input.

- 2) Device with PIN code:

Two different ways of pairing are possible depending on the device:

- Type A:

The message [To pair] [Enter Pin] 0000 will be displayed.

Confirm the PIN code on the device.

The Bluetooth connection will be made.

- Type B:

The message [Pairing request] [Confirm password] together with a 6 digit code will be displayed. The unique and identical code should be displayed on the device. If the code is identical confirm on the device.

The Bluetooth connection will be made.

[Pair device]:

Turn the audio unit Bluetooth® on. See [Bluetooth] description.

Use the audio unit to pair:

Press the button. Select the [Pair Device] key. The pairing procedure depends on the Bluetooth® device to be connected:

- 1) Device without PIN code:

The Bluetooth® connection will be automatically connected without any further input.

2) Device with PIN code:

Two different ways of pairing are possible depending on the device, for the correct procedure details, see "[Pair device]" earlier in this section.

Use the Bluetooth® audio/mobile phone device to pair:

- 1) Follow the instructions in the owner's manual for the Bluetooth® enabled device to search for the audio unit.
If the search mode finds the audio unit it will be shown on the device display.
- 2) Select the audio unit shown as [My Car].
- 3) Follow the instructions in the owner's manual for the Bluetooth® enabled device to establish a connection with the audio unit.
- 4) Enter the PIN code shown on the relevant device with the device's own keypad, and press the confirmation key on the device itself.
Refer to the relevant Bluetooth® device owner's manual for further details.

[Sel. device]:

The paired device list shows which Bluetooth® audio or mobile phone devices have been paired or registered with the Bluetooth® audio system. If the list contains devices then select the appropriate device to connect to the Bluetooth® audio system.

The following symbols (where fitted) indicate the capability of the registered device:

 : Mobile phone integration

 : Audio streaming (A2DP - Advanced Audio Distribution Profile)

[Del. device]:

A registered device can be removed from the Bluetooth audio system. Select a registered device then press <ENTER> to confirm to deletion.

[Bluetooth]:

If Bluetooth® has been switched off a notification message [ON/OFF] appears when you select [Bluetooth] from the phone menu (press ). To switch the Bluetooth® signal on, press <ENTER> and a follow up screen will appear. Then select [ON] and press <ENTER> to display the Bluetooth® settings menu screen.

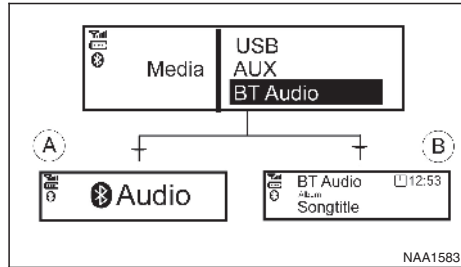

Bluetooth® audio streaming main operation

Turn the ignition switch to the ACC or ON position. If the audio system was turned off while the Bluetooth® audio was playing, pressing the <  > button will start the Bluetooth® audio streaming.

MEDIA button:



To operate the Bluetooth® audio streaming use the following method:

Press <MEDIA> repeatedly until [BT Audio] is shown.

The type of display, (A) or (B), shown on the audio system can vary depending on the Bluetooth® version of the device.







Fast Forward (Cue), Fast Reverse (Review) buttons:

When the  (Cue) or  (Review) button is pressed continuously, the track will be played at high speed. When the button is released, the track will be played at normal playing speed.



Track up/down buttons:

Pressing the  or  button once, the track will be skipped forward to the next track or backward to the beginning of the current played track. Press the  or  button more than once to skip through the tracks.



button

If the song contains music information tags (ID3-tags), the title of the played song will be displayed. If tags are not provided then the display will not show any messages.

When the **DISP** button is pressed repeatedly further information about the song can be displayed along with the song title.

A long press on **DISP** will turn the display into a detailed overview which after a few seconds returns to the main display; or press DISP briefly.

Bluetooth® mobile phone feature

This system offers a hands-free facility for your mobile telephone with Bluetooth® to enhance driving safety, and comfort. For details, see "Bluetooth® Hands-Free Phone System (without navigation system and colour display)" later in this section.

Specification chart

Supported media		CD-R, CD-ROM, CD-RW, USB 2.0 MSC	
CD Size		12 cm diameter. up to 1.9 mm thickness	
Supported file systems for CD		ISO9660 LEVEL1, ISO9660 LEVEL2, Romeo, Joliet * ISO9660 Level 3 (packet writing) is not supported. * Files saved using the Live File System Component (on a Windows Vista-based computer) are not supported.	
Supported file systems for USB		FAT-16, FAT-32	
Supported versions *1	MP3	Version	MPEG1, Layer 3
		Sampling frequency	32 KHz - 44.1 KHz - 48 kHz
		Bit rate	32, 40, 48, 56, 64, 80, 96, 112, 128, 144, 160, 192, 224, 256, 288, 320, Kbps, VBR *4
	WMA *3	Version	WMA7, WMA8, WMA9
		Sampling frequency	16 KHz, 22.05 KHz, 32 KHz, 44.1KHz, 48 kHz
		Bit rate	48, 64, 80, 96, 128, 160, 192, 256, 320 Kbps, VBR *4
	AAC	Version	MPEG-4, AAC
		Sampling frequency	8, 11.025, 16, 22.05, 32, 44.1, 48 kHz
		Bit rate	32, 48, 64, 80, 96, 128, 160, 192 Kbps, VBR *4
Tag information (Song title and Artist and Album name)	CD	CDDA	
	MP3	ID3 tag ver. 1.0, 1.1, 2.2, 2.4	
	WMA	WMA tag	
	AAC	AAC tag	
Tracks/Files support		CDDA — 99 tracks MP3/WMA/AAC in CD — 999 files USB — 30000 files	
Folders support		100 folders in CD 2500 folders in USB Depth — Till 8, Deeper folders shall be under 8, subject to the maximum.	
Playlists support in USB		M3U, WPL, PLS — 1000 playlists.	

Text character support	Adjustable character length, depending upon content of media.	File Name: Min 11 Characters (Max 30 Characters) ID3 TAG : Min 24 Characters. (Max 60 Characters) *5
Displayable character codes *2	Unicode, ISO8859-15(French), ISO8859-5(Russian Cyrillic), GB18030-2000(Chinese), BIG-5(Taiwanese), KSX1001-2002(Korean)	01:ASCII, 02: ISO-8859-1, ISO8859-15(French), ISO8859-5(Russian Cyrillic), 03: UNICODE(UTF-16 BOM Big Endian), 04: UNICODE (UTF-16 Ncn-BOM Big Endian), 05: UNICODE(UTF-8), 06:UNICODE(Non-UTF-16 BOM Little Endian), 07: SHIFT-JIS, GB18030-2000(Chinese), BIG-5(Taiwanese), KSX1001-2002(Korean)
Browsing		File/Folder browsing for CD/MP3, USB

*1 Files created with a combination of 48 kHz sampling frequency and 64 Kbps bit rate cannot be played.

*2 Available codes depend on what kind of media, versions and information are going to be displayed.

*3 Protected WMA files (DRM) cannot be played.

*4 When VBR files are played, the playback time may not be displayed correctly. WMA7 and WMA8 are not applied to VBR.

*5 Support 128 Bytes but it depends on display width and character type.

FM-AM RADIO WITH COMPACT DISC (CD) PLAYER (Type B)

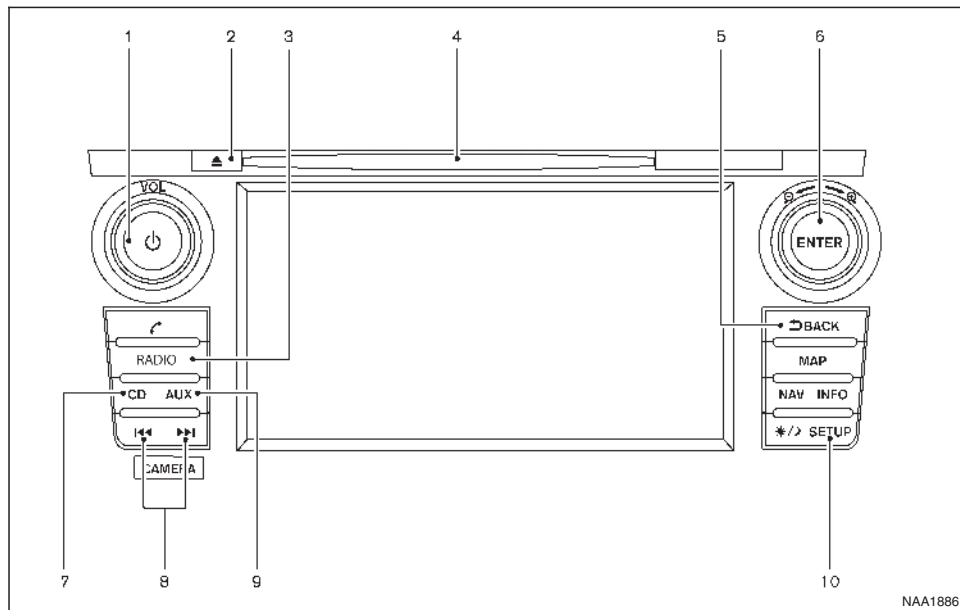

- 1 Power/VOL (volume) dial
- 2 Disc eject button
- 3 RADIO button
- 4 Disc insert slot
- 5 BACK button
- 6 ENTER/Scroll dial
- 7 CD button
- 8 Seek/Track buttons
- 9 AUX (auxiliary) button
10. SETUP button

AUDIO MAIN OPERATION

The audio system operates when the ignition switch is placed in the **ON** or **ACC** position.

 (power)/VOL (volume) dial

Push the <VOL> dial to turn the audio system on and off.

Turn the <VOL> dial to adjust the volume.

This vehicle may be equipped with the Speed Sensitive Volume (SSV) function for audio. When this function is turned on, the audio volume will be adjusted automatically as the vehicle speed changes. For operations to turn the SSV function on and off, see "How to use <SETUP> button" earlier in this section.

Audio settings

For the operations to adjust the audio settings, see "How to use <SETUP> button" earlier in this section.

Traffic Announcement

Touch [TA] on the audio screen to turn on or off the Traffic Information setting. When a traffic announcement is received, the Traffic Information will interrupt the music that was playing and informs the driver of the received traffic information.

Radio operation

The audio system operates when the ignition switch is placed in the **ON** or **ACC** position.

Radio band select button:

Push the <RADIO> button to change the band as follows:

AM → DAB → FM → AM

If another audio source is playing when the **<RADIO>** button is pushed, the audio source playing will automatically be turned off and the last radio station played will begin playing.

Radio tuning:

When in radio mode, the radio can be tuned using the touch screen. To bring up the visual tuner, touch the [Tune] key on the lower part of the screen. A screen appears with a bar running from low frequencies on the left to high frequencies on the right.

One of the following operations can be used for tuning.

- Touching the bar on the screen
- Touching [◀]/[▶] on the screen
- Turning the <ENTER>/Scroll dial

To return to the regular radio display screen, touch the [OK] key.

Station List:

When in FM or DAB (where fitted) mode, touch [FM List] or [DAB List] to display the station lists.



Seek/Track buttons:

When in radio mode, push the Seek/Track buttons to tune from low to high or high to low frequencies and to stop at the next broadcasting station.

Station memory keys:

Up to six stations can be stored for AM band, and up to twelve stations can be stored for each of the other bands.

1. Choose the radio band using the **<RADIO>** button.

2. Tune to the desired station using manual or seek tuning. Touch and hold any of the desired station memory keys until a beep sound is heard.

For FM and DAB (where fitted), touch the [7-12] key to display the 7 - 12 memory keys.

3. The channel indicator will then come on and the sound will resume. Programming is now complete.

DAB operation:

In the DAB mode, the following operation keys and information are available.

DAB List:

Touch to display the available station list.

TA:

Touch this key to turn on and off the TA (Traffic Announcement) mode. When turned on, received TA will interrupt the audio source that is playing.

Extra chan.:

The [Extra chan.] key will allow access to extra stations transmitted within the group of the currently selected station. If extra stations are not available within the group, the key will not operate.

Radio text:

Radio text is shown on the DAB main screen underneath the DAB station name. This displays radio programme and song information as determined by the DAB station.

EAS in EAS test (displayed on the screen as a PTY name) is an abbreviation of Emergency Alert System.

Occasionally, in areas of poor DAB signal strength, the full station name in the DAB List and DAB main screen might be distorted. In this situation it may still be possible to listen to the particular radio station, at a reduced level of sound quality, but this is not always possible. This may also be shown in the vehicle information display.

CD player operation

Loading disc:

Insert a CD into the slot with the label side facing up. The CD will be guided automatically into the slot and will start playing. If the radio is already playing, it will automatically turn off, and the CD will start playing.

CAUTION

Do not force the compact disc into the slot. This could damage the player.



CD button:

When the CD button is pushed with the system off and the CD loaded, the system will turn on and the CD will start to play.

When the CD button is pushed with a CD loaded while the radio playing, the radio will turn off and the CD will start to play.



Seek/Track button:

When the ▶▶ or ◀◀ button is pushed for more than 1.5 seconds while the CD is being played, the CD will play while fast forwarding or rewinding. When the button is released, the CD will return to normal play speed.

When the **▶▶** or **◀◀** button is pushed for less than 1.5 seconds while the CD is being played, the next track or the beginning of the current track on the CD will be played. Push the button several times to skip through the tracks on the CD. If the last track on a CD is skipped, the first track on the disc will play. If the last track in a folder of an MP3 CD is skipped, the first track of the next folder will play.

CD/MP3/WMA display mode:

While listening to a CD or an MP3/WMA CD, certain text may be displayed (when a CD encoded with text is being used). Depending on how the CD or MP3/WMA CD is encoded, the text is displayed listing the artist, album and song title. Operation keys are also displayed on the screen.

Mix:

Touching the [Mix] key while a CD or MP3 CD is playing will alternate the random play pattern as follows:

(CD)

(Normal) → Mix → (Normal)

(CD with compressed audio files)

(Normal) → Random Folder → Random All → (Normal)

Repeat:

Touching the [Repeat] key while a CD or MP3 CD is playing will alternate the repeat play pattern as follows:

(CD)

(Normal) → Repeat → (Normal)

(CD with compressed audio files)

(Normal) → Repeat Track → Repeat Folder → (Normal)

Browse:

Touch the [Browse] key to display the titles on the CD in list format. Touch the title of a song in the list to begin playing that song. If an MP3 CD is playing, touching the [Browse] key will also list the folders on the disc. Touch the [Folder Up] key to view the lists in the upper layer. Follow the procedure for selecting a song with the touch screen to choose a folder.



Disc eject button:

When the Disc eject button is pushed while a CD is loaded, the CD will be ejected.

If the CD is not removed within 10 seconds, the CD will be reloaded.

USB (Universal Serial Bus) Connection Port



WARNING

Do not connect, disconnect or operate the USB device while driving. Doing so can be a distraction. If distracted you could lose control of your vehicle and cause an accident or serious injury.

CAUTION

Do not force the USB device into the USB port. Inserting the USB device tilted or up-side-down into the port may damage the port. Make sure that the USB device is connected correctly into the USB port.

Do not grab the USB port cover (where fitted) when pulling the USB device out of the port. This could damage the port and the cover.

Do not leave the USB cable in a place where it can be pulled unintentionally. Pulling the cable may damage the port.

General notes for USB use:

Refer to your device manufacturer's owner information regarding the proper use and care of the device.

The audio system operates when the ignition switch is placed in the **ON** or **ACC** position.

The USB port is located on the lower part of the instrument panel. See "USB (Universal Serial Bus) connection port" earlier in this section. Connect a USB memory device into the connection port. The USB memory device will be activated automatically.

USB main operation:

If another audio source is playing and a USB memory device is inserted, push the AUX button until the screen on the display changes to the USB memory mode.

If the system has been turned off while the USB memory device was playing, push the Power/<VOL> dial to restart the USB memory device.

Touch the name of a song on the screen to begin playing that song.

USB screen operation:

While files on a USB memory device are playing, the play pattern can be altered so that songs are repeated or played randomly.

Mix:

Touching the [Mix] key on the screen while a USB memory device is playing will alternate the random play pattern as follows:

(Normal) → Random Folder → Random All → (Normal)

Repeat:

Touching the [Repeat] key on the screen while a USB memory device is playing will alternate the repeat play pattern as follows:

(Normal) → Repeat Track → Repeat Folder → (Normal)

Browse:

Touch [Browse] key to display USB interface. Select the songs you wish to play by touching the item on the screen.

**Seek/Track buttons:**

Push the Seek/Track (rewind) button while an audio file on the USB memory device is playing to return to the beginning of the current track. Push the button several times to skip backward several tracks.

Push the Seek/Track (fast forward) button while an audio file on the USB memory device is playing to advance one track. Push the button several times to skip forward several tracks. If the last track on the USB memory device is skipped, the first track of the next folder is played.

iPod player operation

Connecting iPod:

Connect the iPod to the USB connection port using the USB cable that came with your iPod.

The USB port is located on the lower part of the instrument panel. See “USB (Universal Serial Bus) connection port” earlier in this section.

If your iPod supports charging via a USB connection, its battery will be charged while connected to the vehicle with the ignition switch placed in the **ON** or **ACC** position.

Compatibility:

The following models are compatible:

iPod 5th Generation (firmware version 1.2.3 or later)

iPod Classic (firmware version 1.1.1 or later)

iPod Touch (firmware version 2.0.0 or later)*

iPod nano - 1st generation (firmware version 1.3.1 or later)

iPod nano - 2nd generation (firmware version 1.1.3 or later)

iPod nano - 3rd generation (firmware version 1.1.3 or later)

iPod nano - 4th generation (firmware version 1.0.4 or later)

iPod nano - 5th generation (firmware version 1.0.1 or later)

* Some features of this iPod may not be fully functional.

Make sure that your iPod firmware is updated to the version indicated above.

“Made for iPod”, “Made for iPhone”, and “Made for iPad” mean that an electronic accessory has been designed to connect specifically to iPod, iPhone, or iPad, respectively, and has been certified by the developer to meet Apple performance standards.

Apple is not responsible for the operation of this device or its compliance with safety and regulatory standards.

Please note that the use of this accessory with iPod, iPhone, or iPad may affect wireless performance.

iPad, iPhone, iPod, iPod classic, iPod nano, iPod shuffle, and iPod touch are trademarks of Apple Inc., registered in the U.S. and other countries. Lightning is a trademark of Apple Inc.

iPod main operation:

If the system has been turned off while the iPod was playing, pushing the Power/<VOL> dial will start the iPod.

If another audio source is playing and a iPod is connected, push the AUX button until the screen on the display changes to the iPod mode.

Refer to your device manufacturer’s owner information regarding the proper use and care of the device.

Interface operation:

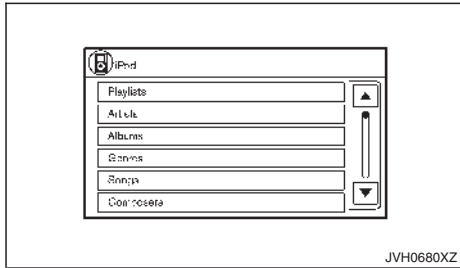

The interface for iPod operation shown on the vehicle's audio system display screen is similar to the iPod interface. Use the touch screen, BACK button or the <ENTER>/Scroll dial to navigate the menus on the screen.

When the iPod is playing, touch the [Menu] key to bring up the iPod interface.

Depending on the iPod model, the following items may be available on the menu list screen. For further information about each item, see the iPod Owner's Manual.

- Playlists
- Artists
- Albums
- Genres
- Songs
- Composers
- Audiobooks
- Podcasts

Scrolling menus:

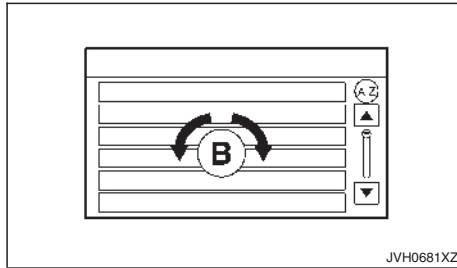

While navigating long lists of artists, albums or songs in the music menu, it is possible to scroll the list by the first character in the name. To activate character indexing, touch the [A-Z] key in the upper right corner of the screen. Turn the <ENTER>/Scroll dial to choose the number or letter to jump to in the list and then push the <ENTER>/Scroll dial.

If no character is selected after thirty seconds, the display returns to normal.

Random and repeat play mode:

While the iPod is playing, the play pattern can be altered so that songs are repeated or played randomly.

Mix:

Touching the [Mix] key on the screen while an iPod is playing will alternate the random play pattern as follows:

(Normal) → Shuffle Songs → (Normal)

Repeat:

Touching the [Repeat] key on the screen while an iPod is playing will alternate the repeat play pattern as follows:

(Normal) → Repeat Song → (Normal)



Seek/Track buttons:

Push the ►► or ◀◀ button to skip backward or forward one track.

Push and hold the ►► or ◀◀ button for 1.5 seconds while a track is playing to reverse or fast forward the track being played. The track plays at an increased speed while reversing or fast forwarding. When the button is released, the track returns to normal play speed.

Bluetooth® audio player operation

If you have a compatible Bluetooth® audio device that is capable of playing audio files, the device can be connected to the vehicle's audio system so that the audio files on the device play through the vehicle's speakers

Bluetooth® trademark:



Bluetooth® is a trademark owned by Bluetooth SIG, Inc. and licensed to Robert Bosch GmbH.

Connecting Bluetooth® audio:



To connect your Bluetooth® audio device to the vehicle, follow the procedure below:

1. Push the <SETUP> button.
2. Select the [Telephone & Bluetooth] key.
3. Select the [Pair New Device] key.
4. The system acknowledges the command and asks you to initiate connecting from the phone handset. The connecting procedure of the mobile phone varies according to each mobile phone model. See the Bluetooth® device Owner's Manual for details.

Bluetooth® audio player main operation:

To switch to the Bluetooth® audio mode, push the AUX button repeatedly until the Bluetooth® audio mode is displayed on the screen.

The controls for the Bluetooth® audio are displayed on the screen.

AUX device player operation

The AUX input jack is located on the lower part of the instrument panel. See "AUX (Auxiliary) input jack" earlier in this section. The AUX audio input jack accepts any standard analog audio input such as from a portable cassette tape/CD player, MP3 player or laptop computer.

RENAULT strongly recommends using a stereo mini plug cable when connecting your music device to the audio system. Music may not play properly when a monaural cable is used.

AUX button:

To switch to the AUX mode, push the AUX button until the AUX mode is selected while the ignition switch is placed in the **ON** or **ACC** position.

TOUCHSCREEN NAVIGATION (where fitted)

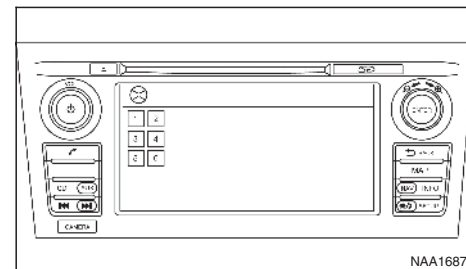

For details, see the separately provided Touchscreen Navigation Owner's Manual.

STEERING WHEEL SWITCH FOR AUDIO CONTROL (where fitted)

AUDIO CONTROL

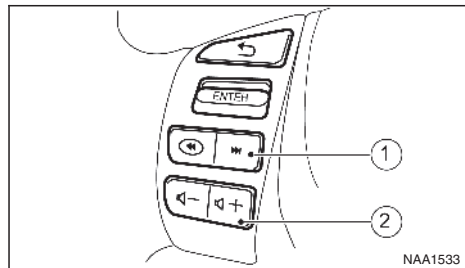

Type A

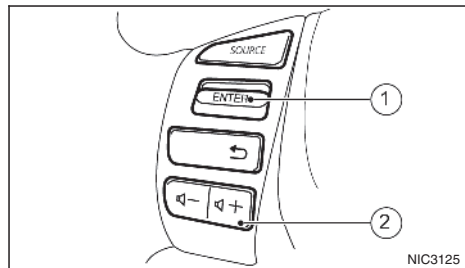



Type B

- ① Tuning buttons (Type A)/ Tuning  switch (Type B)
- ② Volume buttons



Tuning/track select switch

Push the switch to select a channel, or track.







Preset station change (radio mode)

Push the up/down scrolling button ( ,  or ) for less than 1.5 seconds to select one of the preset radio stations.

Seek tuning (radio mode) – where fitted

Push the up/down scrolling button ( ,  or ) for more than 1.5 seconds to seek for the next or previous radio station.

Track up/down (CD, iPod, USB memory or Bluetooth audio* mode) – *: where fitted

- Push the up/down scrolling button ( ,  or ) for less than 1.5 seconds to select the next track or to return to the beginning of the present track. Push (up/down) several times to skip through or skip back the tracks.
- Push the up/down scrolling button ( ,  or ) for more than 1.5 seconds to select the next folder or the previous folder.

Volume control buttons

Push the volume control button (+ or -) to increase or decrease the volume.

PHONE CONTROL BUTTONS

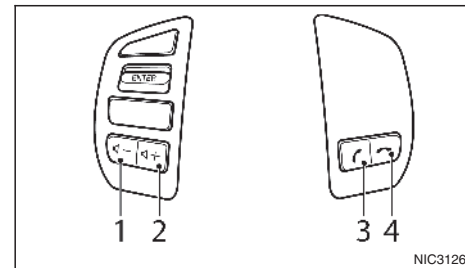



- ① Volume down button
- ② Volume up button
- ③ Phone accept button
- ④ Phone decline button

Steering wheel phone control buttons



The hands-free mode can be operated using the controls on the steering wheel.

Volume control buttons:

The volume control buttons allow you to adjust the volume of the speakers by pushing the  or  buttons ① and ②.

BLUETOOTH® HANDS-FREE PHONE SYSTEM (without navigation system and colour display)

Phone buttons:

The  or  buttons ③ and ④ allow you to:

Accept an incoming call by pressing the  button.

Reject an incoming call by pressing the  button during the incoming call.

End an active call by pushing the  button once.

Redial the last outgoing call by pressing the  button for more than 2 seconds.

BLUETOOTH® MOBILE PHONE FEATURE



WARNING

Whilst driving, using the mobile phone is extremely dangerous because it significantly impairs your concentration and diminishes your reaction capabilities to sudden changes on the road, and it may lead to a fatal accident. This applies to all phone call situations such as when receiving an incoming call, during a phone conversation, when calling through the phone book search, etc.

CAUTION

Certain country jurisdictions prohibit the use of the mobile phone in the car without hands-free support.

This chapter provides information about the hands-free phone system using a Bluetooth® connection.

Bluetooth® is a wireless radio communication standard. This system offers a hands-free facility for your mobile telephone to enhance driving comfort.

In order to use your mobile phone with the Bluetooth® of the audio system, the mobile phone must first be setup. For details, see "BLUETOOTH® settings" later in this section. Once it has been setup, the hands-free mode is automatically activated on the registered mobile phone (via Bluetooth®) when it comes into range.

A notification message appears on the audio display when the phone is connected, when an incoming call is being received, as well as when a call is initiated.

When a call is active, the audio system, microphone (located in the ceiling in front of the rear view mirror), and steering wheel switches enable hands-free communication.

If the audio system is in use at the time, the radio, CD, iPod, USB audio, Bluetooth audio or AUX source mode will be muted and will stay muted until the active call has ended.

The Bluetooth® system may not be able to connect with your mobile phone for the following reasons:

- The mobile phone is too far away from the vehicle.

- The Bluetooth® mode on your mobile phone has not been activated.

- Your mobile phone has not been paired with the Bluetooth® system of the audio unit.

- The mobile phone does not support Bluetooth® technology (BT Core v2.0).

NOTE

For models with Audio with Navigation system see the separately provided Owner's Manual.

For details, see your mobile phone's Owner's Manual.

For assistance with your mobile phone integration, please visit your local approved dealer.

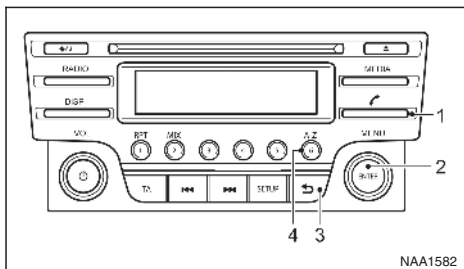

- ① Phone button
- ② **<MENU>** or **<ENTER>** button (rotate and push to select)
- ③ (Back) button
- ④ Phone book quick search button **A-Z**

BLUETOOTH® settings

Enter the phone setup menu via the (phone) button, select the [Bluetooth] key, and then check if the bluetooth is set to on (default setting is on, push the **<ENTER>** button if not).

To setup the Bluetooth system to pair (connect or register) your preferred mobile phone, follow the following procedure.

To pair a device, use the [Scan device] key or the [Pair device] key.

Up to 5 different Bluetooth devices can be connected. However, only one device can be used at a time. If 5 different Bluetooth registered devices are registered, a new device can only replace one of the 5 existing paired devices. Use [Del. device] key to delete one of the existing paired devices. For details, see "[Del. device]" later in this section.

When successfully paired a notification message will be displayed, then the audio system display will return to the current audio source display. During connection the following status icons will be displayed (top left of the display): Signal strength (), Battery status* () and Bluetooth "ON" ().

*: If the low battery message comes on, the Bluetooth® device must be recharged soon.

The pairing procedure and operation may vary according to device type and compatibility. See the Bluetooth® owner's manual for further details.

NOTE

For device details, see your audio/mobile phone Owner's Manual.

For assistance with the Bluetooth® audio/mobile phone integration, please visit your local approved dealer.

A maximum of 5 Bluetooth devices can be paired with the system.

To set up the Bluetooth system with a device the following items are available:



[Scan devices]

Shows all available visible Bluetooth devices and initializes Bluetooth connection from the audio unit.

[Pair device]

Initializes Bluetooth connection from the mobile device.

[Sel. device]

Paired Bluetooth devices are listed and can be selected for connection.



[Del. device]

A registered Bluetooth device can be deleted.

[Bluetooth]

If this setting is turned off, the connection between the Bluetooth devices and the in-vehicle Bluetooth module will be cancelled.

[Scan devices]:

- 1) Press the  button. Select [Scan device]
The audio unit searches bluetooth devices and shows all visible devices.
Pressing the  button cancels the search.
- 2) Select the device to be paired.
Use the **<MENU>** dial and press to select.
- 3) The pairing procedure depends on the device to be connected:
 - 1) Device without PIN code:
The Bluetooth connection will be automatically connected without any further input.
 - 2) Device with PIN code:
Two different ways of pairing are possible depending on the device:
 - Type A:
The message [To pair] [Enter Pin] 0000 and a count down timer will be displayed. Confirm the PIN code on the device.
The Bluetooth connection will be made.
If the count down timer reaches 0 the attempt to pair the devices will be cancelled.
 - Type B:
The message [Pairing request] [Confirm password] together with a 6 digit code will be displayed. The unique and identical code should be displayed on the device. If the code is identical confirm on the device.
The Bluetooth connection will be made.



[Pair device]:

- Turn the audio unit Bluetooth on. See [Bluetooth] description.
- Use the audio unit to pair:
Press the  button. Select the [Pair device] key. The Audio unit will wait for a connection request from the mobile device.
The pairing procedure depends on the Bluetooth device:
- 1) Device without PIN code:
The Bluetooth connection will be automatically connected without any further input.
 - 2) Device with PIN code:
Two different ways of pairing are possible depending on the device, see under [Scan device] for a description.
- Use the Bluetooth® audio/mobile phone device to pair:
- 1) Switch **ON** the Bluetooth® devices search mode on the mobile device.
If the search mode finds the audio unit it will be shown on the device display.
 - 2) Select the audio unit shown as [My Car].
 - 3) Enter the number code shown on the relevant device with the device's own keypad, and press the confirmation key on the device itself.
Refer to the relevant Bluetooth® device owner's manual for further details.

[Sel. device]:

The paired device list shows which Bluetooth® audio or mobile phone devices have been paired or registered with the Bluetooth® audio system. If the list contains devices then select the appropriate device to connect to the Bluetooth® audio system.

The following symbols (where fitted) indicate the capability of the registered device:

-  : Mobile phone integration
-  : Audio streaming (A2DP – Advanced Audio Distribution Profile)



[Del. device]:

A registered device can be removed from the Bluetooth audio system. Select a registered device then press **<ENTER>** to confirm the deletion.

[Bluetooth]:

If Bluetooth® has been switched off a notification message [ON/OFF] appears when you select [Bluetooth] from the phone menu (press ). To switch the Bluetooth® signal on, press **<ENTER>** and a follow up screen will appear. Then select [ON] and press **<ENTER>** to display the Bluetooth® settings menu screen.

HANDS-FREE TELEPHONE CONTROL

The hands-free mode can be operated using the telephone  button on the audio system, or the  and (where fitted) on the steering wheel.

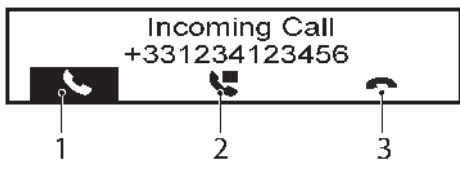

Receiving a call

When receiving an incoming call, the display will show the caller's phone number (or a notification message that the caller's phone number cannot be shown) and three operation icons.

1. Answering and during a call:

Answer the call by pressing <ENTER> (the  is highlighted).

By pressing <ENTER>, you can select the following options:

Ending the call by selecting  and press <ENTER>.

Put the call on hold by selecting  and press <ENTER>.

[]

Use this item (the transfer handset command) to transfer the call from the audio system to your mobile phone.

To transfer the call back to hands-free via the audio system select [].

[#123]

Use this item to enter numbers during a call. For example, if directed by an automated phone system to dial an extension number the system will send the tone associated with the selected number.

2. Put a call on hold:

Rotate the <MENU> dial until  is highlighted, press <ENTER>. The call is on hold. Pressing <ENTER> accepts the call, rotate the <MENU> dial clockwise and press <ENTER> to reject.

3. Rejecting a call:

Rotate the <MENU> dial until  is highlighted, press <ENTER>. The call is rejected.



Initiating a call

A call can be initiated using one of the following methods:

- Making a call from the phone book
- Manually dialling a phone number
- Redialling
- Using call history (Call List menu)

Dialled
Received
Missed

Making a call from the phone book:

Once the Bluetooth® connection has been made, between the registered mobile phone and the audio system, phone book data will be transferred automatically to the audio system. The transfer may take a while before completion.

NOTE



Phone book data will be erased when:

Switching to another registered mobile phone.

Mobile phone is disconnected.

The registered mobile phone is deleted from the audio system.

1. Press < >.
2. Turn the <MENU> dial and scroll down to [Phone Book] then press <ENTER>.
3. Scroll down through the list, select the appropriate contact name (highlighted), and press <ENTER>.
4. A following screen will show the number to be dialled. If correct, press <ENTER> again to dial the number.

If the contact has more numbers assigned for , , or , scroll, and select the appropriate number to dial.

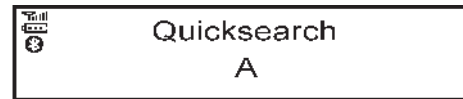

Alternatively, the quick search mode can be used as follows:

1. While in the phonebook screen press **<A-Z/&6>**.
2. Turn the **<MENU>** dial for the first alphabetic or numerical letter of the contact name. Once highlighted, press **<ENTER>** to select the letter.
3. The display will show the corresponding contact name(s). Where necessary, use the **<MENU>** dial again to scroll further for the appropriate contact name to call.
4. A following screen will show the number to be dialled. If correct, press **<ENTER>** again to dial the number.

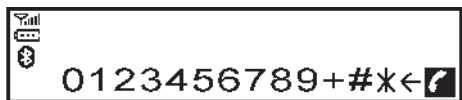

Manually dialling a phone number:



WARNING

Park the vehicle in a safe location, and apply the parking brake before making a call.

To dial a phone number manually use the audio system display (virtual keyboard pad) as follows:

1. Press , and turn the **<MENU>** dial to highlight [Dial Number].
2. Press **<ENTER>** to select [Dial Number].

3. Turn the **<MENU>** dial to scroll along, and select each number of the phone number. Once highlighted, press **<ENTER>** after each number selection.

To delete the last number entered scroll to the **[←]** (Backspace) symbol, and once highlighted press **<ENTER>**. The last number will be deleted. Pressing **<ENTER>** repeatedly will delete each subsequent number.

4. After entering the last number, scroll to the  symbol, and press **<ENTER>** to dial the number.

Redial:

To redial or call the last number dialled, press  for more than 2 seconds.



Using call history (Call List menu):

A number from the dialled, received, or missed call lists can also be used to make a call.

[Dialled]



Use the dialled call mode to make a call which is based on the list of outgoing (dialled) calls.

[Received]

Use the received call mode to make a call which is based on the list of received calls.

[Missed]

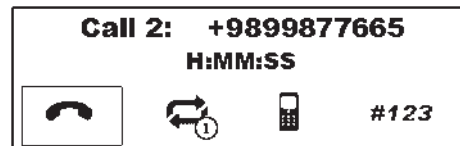

Use the missed call mode to make a call which is based on the list of missed calls.

1. Press , and select [Call List].
2. Turn the **<MENU>** dial to scroll to an item, and press **<ENTER>** to select it.
3. Scroll to the preferred phone number then press **<ENTER>**, or press  to dial the number.



Second incoming call

Whenever there is a second incoming call is shown in the display. By selecting the  icon the call is accepted and the current call is put on hold.

Selecting  by rotating **<MENU>** and pressing **<ENTER>** rejects the second incoming call. When this is done during the conversation it ends the call. Selecting the  key using the **<MENU>** dial and pressing **<ENTER>** switches between the phone conversations.

(For the other selections, see Making a call from the phone book earlier)



General settings

From the phone menu select [Settings]

Volume settings and manually downloading the phonebook can be done using this menu.

Menu operation:

Press **<ENTER>** to select, rotate the **<MENU>** dial to increase or decrease the volume.

Press **<ENTER>** to confirm.

Menu items:

[Volume]

- [Ring]
Set the phone ringing volume
- [Call]
Set the volume of the conversation during a call.

[Ringtone]

- [Car]
Choose the in car ringtone.
- [Phone]
Choose the phone ringtone.

[PB download]

Download the phonebook of the mobile device to the audio unit manually.

STEERING WHEEL SWITCHES (where fitted)

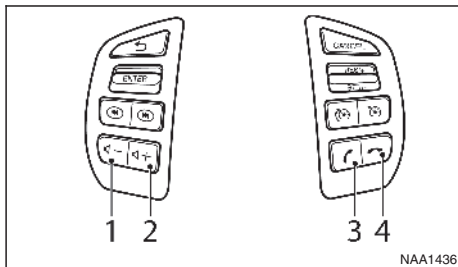

- ① Volume down button
- ② Volume up button
- ③ Phone button
- ④ Phone end/reject button

The hands-free mode can be operated using the steering wheel switches.

Volume down button

Press the volume down button to decrease the volume of the speakers.

Volume up button

Press the volume up button to increase the volume of the speakers.

Phone button

The phone  button allows you to:

Accept an incoming call by pressing once.

Redial the last outgoing call by pressing the button for more than 2 seconds.

Phone END button

Reject an incoming call by pressing  during an incoming call.

End an active call by pressing  once.

BLUETOOTH® HANDS-FREE PHONE SYSTEM (with navigation system)



WARNING

Use a phone after stopping your vehicle in a safe location. If you have to use a phone while driving, exercise extreme caution at all times so full attention may be given to vehicle operation.

If you are unable to devote full attention to vehicle operation while talking on the phone, pull off the road to a safe location and stop your vehicle.

CAUTION

To avoid discharging the vehicle battery, use a phone after starting the engine.

Your vehicle is equipped with the Bluetooth® Hands-Free Phone System. If you have a compatible Bluetooth® enabled mobile phone, you can set up the wireless connection between your mobile phone and the in-vehicle phone module. With Bluetooth® wireless technology, you can make or receive a hands-free telephone call with your mobile phone in the vehicle.

Once your mobile phone is connected to the in-vehicle phone module, no other phone connecting procedure is required. Your phone is automatically reconnected with the in-vehicle phone module when the ignition switch is placed in the ON position with the connected mobile phone turned on and carried in the vehicle.

You can register up to 5 different Bluetooth® mobile phones to the in-vehicle phone module. However, you can talk on only one mobile phone at a time.

Before using the Bluetooth® Hands-Free Phone System, refer to the following notes.

Set up the wireless connection between a mobile phone and the in-vehicle phone module before using the Bluetooth® Hands-Free Phone System.

Some Bluetooth® enabled mobile phones may not be recognised by the in-vehicle phone module.

You will not be able to use a hands-free phone under the following conditions:

- Your vehicle is outside of the mobile service area.
- Your vehicle is in an area where it is difficult to receive mobile signal; such as in a tunnel, in an underground parking garage, near a tall building or in a mountainous area.
- Your mobile phone is locked to prevent it from being dialled.

When the radio wave condition is not ideal or ambient sound is too loud, it may be difficult to hear the other person's voice during a call.

Immediately after the ignition switch is placed in the ON position, it may be impossible to receive a call for a short period of time.

Do not place the mobile phone in an area surrounded by metal or far away from the in-vehicle phone module to prevent tone quality degradation and wireless connection disruption.

While a mobile phone is connected through the Bluetooth® wireless connection, the battery power of the mobile phone may discharge quicker than usual. The Bluetooth® Hands-Free Phone System cannot charge mobile phones.

Some mobile phones or other devices may cause interference or a buzzing noise to come from the audio system speakers. Storing the device in a different location may reduce or eliminate the noise.

Refer to the mobile phone owner's manual regarding the telephone charges, mobile phone antenna and body, etc.

The signal strength display on the monitor will not coincide with the signal strength display of some mobile phones.

REGULATORY INFORMATION

Bluetooth® trademark



Bluetooth® is a trademark owned by Bluetooth SIG, Inc. and licensed to Robert Bosch GmbH.

EU RED Directive 2014/53/EU

Hereby, Robert Bosch Car Multimedia GmbH declares that the radio equipment type LCN2K70A00/LCN2K70A10 is in compliance with Directive 2014/53/EU. The full text of the EU declaration of conformity is available at the following internet address: <http://cert.bosch-carmultimedia.net>

Any change of the radio equipment or usage with other accessories, components or software as specified will make a re-assessment according compliance to the legal approval necessary.

Frequency Band	Radiated Power (EIRP)	Hints/Restriction
2400 MHz - 2480 MHz	Bluetooth <10 mW	Internal not accessible by user

CONTROL BUTTONS AND MICROPHONE

Steering wheel switch:

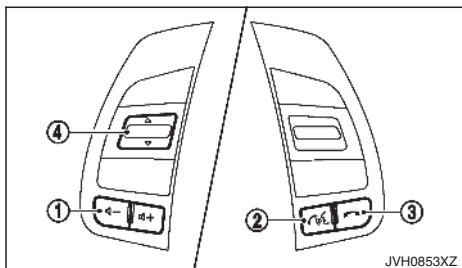

1. Volume control +/- - switch
2. Phone send button
3. Phone end button
4. Tuning switch

Control panel:

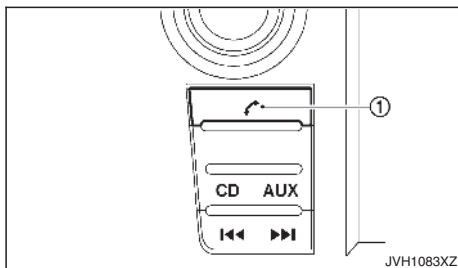

1. Phone button

Microphone:

Microphone is located near the map lights.

PAIRING PROCEDURE

NOTE

The connecting procedure must be performed when the vehicle is stationary. If the vehicle starts moving during the procedure, the procedure will be cancelled.

1. Push the <SETUP> button on the control panel.
2. Touch the [Telephone & Bluetooth] key.
3. Touch the [Pair New Device] key.
If no device has been paired yet all other options will be unavailable.
4. Initiate the pairing process from the handset. The system will display the message asking if PIN is displayed on your Bluetooth® device.

1. If the PIN is displayed on your Bluetooth® device, select [Yes] to complete the pairing process.
2. If the PIN is not displayed on your Bluetooth® device, select [No] and complete the pairing process according to the instructions in the Bluetooth® device's Owner's Manual.

For more information, see the Bluetooth® device's Owner's Manual.

PHONEBOOK

To access the vehicle phonebook:

1. Push the button on the control panel.
2. Select the "Contacts" key.
3. Choose the desired entry from the displayed list.
4. The number of the entry will be displayed on the screen. Touch the number to initiate dialling.

NOTE

To scroll quickly through the list, touch the "A-Z" key in the upper right corner of the screen. Turn the ENTER/Scroll dial to choose a letter or number and then push the ENTER/Scroll dial. The list will move to the first entry that begins with that number or letter.

MAKING A CALL

To make a call, follow the procedure below:

1. Push the  on the control panel. The "Phone" screen will appear on the display.
2. Select one of the following options to make a call:

"Contacts": Select the name from an entry stored in the vehicle phonebook.

"Call Lists": Select the name from the incoming, outgoing or missed.

"Redial": Dial the last outgoing call from the vehicle.

: Input the phone number manually using a keypad displayed on the screen. For information on how to use the touch screen, see "How to use touch screen display" in this section.

RECEIVING A CALL

When a call is placed to the connected phone, the display will change to phone mode.

To accept the incoming call, take one of the following actions.

Push the  button on the steering wheel.

Touch the "" icon on the screen.

To reject the incoming call, take one of the following actions.

Push the  button on the steering wheel.

Touch the red phone "" icon on the screen.

DURING A CALL

While a call is active, the following options are available on the screen:

"Handset"

Select this option to switch control of the phone call over to the handset.



"Mute Mic."

Select this option to mute the microphone. Select again to reactivate the microphone.

"" icon

Select to end the phone call.

ENDING A CALL

To end a phone call, select the [] icon on the screen or push the <> button on the steering wheel.

BLUETOOTH® SETTINGS

To access the Bluetooth® settings screen:

1. Push the <SETUP> button.
2. Touch the [Telephone & Bluetooth] key.

Available setting items:

[Telephone Setup]

See "Telephone setup" later in this section for details.

[Pair New Device]

Select to pair a new Bluetooth® device to the Bluetooth® Hands-Free Phone System.

[Select Paired Device]

Select to choose a Bluetooth® device from a list of those devices paired to the Bluetooth® Hands-Free Phone System.

[Delete Paired Device]

Select to delete a Bluetooth® device from a list of those devices connected/paired to the Bluetooth® Hands-Free Phone System.

[Bluetooth]

Select to toggle Bluetooth® **ON** or **OFF**.

TELEPHONE SETUP

To access the phone settings screen:

1. Push the <SETUP> button.
2. Touch the [Telephone & Bluetooth] key.
3. Touch the [Telephone Setup] key.

Available setting items:

[Sort Phonebook By]*

Select [First Name] or [Last Name] to choose how phonebook entries are alphabetically displayed on the screen.

[Phonebook]*

Select [Phone] to use the handset's phonebook. Select [SIM] to use the phonebook on the SIM card. Select [Both] to use both sources.

[Download Phonebook Now]

Select to download the phonebook to the vehicle from the chosen source.

[Phone Notifications for]

Select [Driver] to have phone notifications shown in the vehicle information display. Select [Both] to have phone notifications shown in both the vehicle information display and the display.

*: These items are only available after the phone-book has been downloaded.

NOTE

5 Starting and driving

Running-in schedule	5-2	Starting engine (models without Remote Control Key system)	5-12
Before starting engine	5-2	Starting engine (models with Remote Control Key system)	5-13
Precautions when starting and driving	5-2	Driving the vehicle	5-13
Exhaust gas (carbon monoxide)	5-3	Driving with Automatic Transmission (AT)	5-13
AdBlue® Selective Catalytic Reduction (SCR) system (where fitted for diesel engine model)	5-3	Driving with Manual Transmission (MT)	5-16
Diesel Particulate Filter (DPF) (where fitted)	5-5	Stop/Start System (where fitted)	5-17
Automatic regeneration	5-6	Stop/Start System display	5-18
On-road and off-road driving precautions	5-6	Stop/Start OFF switch	5-20
Driving safety precautions	5-6	Four-Wheel Drive (4WD) (where fitted)	5-20
Turbocharger system	5-8	Part time 4WD system	5-21
Care when driving	5-8	4WD mode switch operation	5-24
Engine cold start period	5-8	4WD mode indicator	5-24
Loading luggage	5-8	4WD warning	5-25
Driving in wet conditions	5-8	Tyre recommendation for 4WD	5-25
Driving in winter conditions	5-8	Rear differential locking system (where fitted)	5-26
Ignition switch (models without Remote Control Key system)	5-8	Electronic Stability Programme (ESP) system (where fitted)	5-27
Manual Transmission (MT)	5-8	Electronic Stability Programme (ESP) OFF switch	5-28
Automatic Transmission (AT)	5-9	Active Emergency Braking system (where fitted)	5-29
Key positions	5-9	System operation	5-29
Steering lock	5-9	Hill descent control system (where fitted)	5-31
Push-button ignition switch (models with Remote Control Key system)	5-10	Hill descent control switch	5-32
Precautions on push-button ignition switch operation	5-10	Hill start assist system (where fitted)	5-32
Remote Control Key system	5-10	Cruise control (where fitted)	5-33
Automatic Transmission (AT)	5-10	Precautions on cruise control	5-33
Steering lock	5-11	Cruise control operations	5-34
Ignition switch positions	5-11	Speed limiter (where fitted)	5-35
Remote Control Key battery discharge	5-12	Speed limiter operations	5-36
		ECO drive report	5-37

Parking.....	5-38
Parking sensor (sonar) system (where fitted)	5-39
Parking sensor (sonar) system OFF switch.....	5-40
Parking sensor (sonar) system settings.....	5-40
Trailer towing	5-41
Operating precautions	5-41
Tyre pressure.....	5-41
Safety chains.....	5-41
Trailer brakes.....	5-41
Trailer detection (where fitted).....	5-41
Vehicle security	5-42

Power steering system.....	5-42
Brake system.....	5-42
Brake precautions.....	5-42
Anti-lock Braking System (ABS)	5-43
Cold weather driving.....	5-44
Battery	5-44
Engine coolant.....	5-44
Tyre equipment.....	5-44
Special winter equipment.....	5-45
Parking brake.....	5-45
Corrosion protection	5-45

RUNNING-IN SCHEDULE

During the first 1,600 km (1,000 miles), follow these recommendations to obtain maximum engine performance and ensure the future reliability and economy of your new vehicle. Failure to follow these recommendations may result in shortened engine life and reduced engine performance.

Do not drive at a constant speed, either fast or slow, for long periods of time.

Do not run the engine over 4,000 rpm.

Do not accelerate at full throttle in any gear.

Do not start quickly.

Do not brake hard as much as possible.

Do not tow a trailer for at least the first 800 km (500 miles).

BEFORE STARTING ENGINE



WARNING

The driving characteristics of your vehicle will change remarkably by any additional load and its distribution, as well as by adding optional equipment (trailer coupling, roof rail, etc.). Your driving style and speed must be adjusted according to the circumstances. Especially when carrying heavy loads, your speed must be reduced adequately.

Make sure the area around the vehicle is clear.

Check fluid levels such as engine oil, coolant, brake (and clutch) fluid, window washer fluid as frequently as possible, at least whenever you refuel.

Visually inspect tyres for their appearance and condition. Measure and check the tyre pressure for proper inflation.

Check that all windows and lights are clean.

Adjust the seat and head restraint positions.

Adjust the inside and outside rearview mirror positions.

Fasten your seat belt and ask all passengers to do the same.

Check that all doors are closed.

Check the operation of the warning lights when the ignition switch is placed in the "ON" position.

Maintenance items in the "8. Maintenance and do-it-yourself" section should be checked periodically.

PRECAUTIONS WHEN STARTING AND DRIVING



WARNING

Never leave children or adults who would normally require the support of others alone in your vehicle. Pets should not be left alone either. They could unknowingly activate switches or controls, or move the vehicle, and inadvertently become involved in a serious accident and injure themselves. On hot, sunny days, temperatures in a closed vehicle could quickly become high enough to cause severe or possibly fatal illness to people or animals.

Properly secure all cargo to help prevent it from sliding or shifting. Do not place cargo higher than the seatbacks. In a sudden stop or collision, unsecured cargo could cause personal injury.

NOTE

During the first few months after purchasing a new vehicle, if you smell strong odours of Volatile Organic Compounds (VOCs) inside the vehicle, ventilate the passenger compartment thoroughly. Open all the windows before entering or while in the vehicle. In addition, when the temperature in the passenger compartment rises, or when the vehicle is parked in direct sunlight for a period of time, turn off the air recirculation mode of the air conditioner and/or open the windows to allow sufficient fresh air into the passenger compartment.

EXHAUST GAS (carbon monoxide)



WARNING

Do not breathe exhaust gas; it contains colourless and odourless carbon monoxide. Carbon monoxide is dangerous. It can cause unconsciousness or death.

If you suspect that exhaust fumes are entering the vehicle, drive with all windows fully open, and have the vehicle inspected immediately.

Do not run the engine in closed spaces such as a garage.

Do not park the vehicle with the engine running for an extended period of time.

If electrical wiring or other cable connections must pass to a trailer through the seal of the body, follow the manufacturer's recommendations to prevent carbon monoxide entry into the vehicle.

If a special body or other equipment is added for recreational or other usage, follow the manufacturer's recommendation to prevent carbon monoxide entry into the vehicle. (Some recreational vehicle appliances such as stoves, refrigerators, heaters, etc. may also generate carbon monoxide.)

The exhaust system and body should be inspected by a qualified mechanic whenever:

- Your vehicle is raised while being serviced.
- You suspect that exhaust fumes are entering into the passenger compartment.

- You notice a change in the sound of the exhaust system.
- You have had an accident involving damage to the exhaust system, underbody, or rear of the vehicle.

AdBlue® SELECTIVE CATALYTIC REDUCTION (SCR) SYSTEM (where fitted for diesel engine model)

AdBlue® or Diesel Exhaust Fluid (DEF), is a non-toxic solution of 32.5% urea in de-ionized water. This fluid is sprayed into the exhaust system of diesel vehicles to cause a chemical reaction that breaks down potentially dangerous NOx (nitrogen oxides) emissions into harmless nitrogen and water. This system is called Selective Catalytic Reduction (SCR). AdBlue® fluid is not a fuel additive and is never mixed with diesel fuel. It is always stored in a separate tank on the vehicle.

AdBlue® will begin to freeze below -11°C (12°F). If you often drive in areas where the temperature is below -11°C (12°F), the AdBlue® tank should always be filled with AdBlue® at the beginning of the cold season to ensure enough defrosting capacity with heating.

AdBlue® warning display

If the AdBlue® level in the tank is low or there is a malfunction in the AdBlue® SCR system, a warning message will appear in the vehicle information display.

Refill AdBlue®:

For information on refilling the AdBlue® tank see "AdBlue® filler lid and cap" in the "3. Pre-driving checks and adjustments" section and "AdBlue® tank

(where fitted for diesel engine model)" in the "8. Maintenance and do-it-yourself" section.

Condition A



This warning appears when the AdBlue® level in the tank is getting low. The message will be displayed each time the engine starts when there is estimated to be between 2400 and 1000 km (1491 and 621 miles) left before the AdBlue® tank is empty. The message can be cleared from the display until the next time the engine is started.

Refill the AdBlue® tank as soon as possible.

Condition B

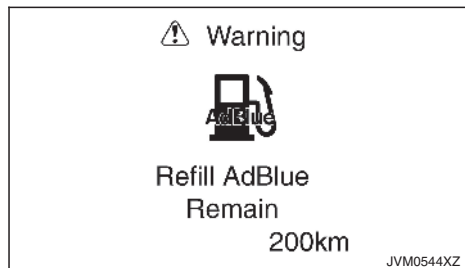

This warning provides you with an estimation of the distance (0 to 1000 km (0 to 621 miles)) that can be driven before the AdBlue® tank level is empty. This message will be displayed continuously; it cannot be cleared from the display.

Condition C



This warning appears when the AdBlue® tank is almost empty.

If this warning appears while the engine is stopped, the engine cannot be started. Contact an approved dealer or qualified workshop.

If this warning appears while the engine is running, the vehicle can still be driven to the nearest approved dealer or qualified workshop.

If the ignition switch is turned off while this warning appears, the engine can be restarted within 3 minutes. Stop the vehicle in a safe place and contact an approved dealer or qualified workshop.

Refill the AdBlue® tank as soon as possible.

After the AdBlue® tank is refilled, place the ignition switch in the **ON** position and check that the warning has turned off. Place the ignition switch in the **OFF** position once and then start the engine.

Check AdBlue®:

When the [Check AdBlue] warning appears, the Malfunction Indicator Light (MIL) may also illuminate depending on conditions.

Condition A

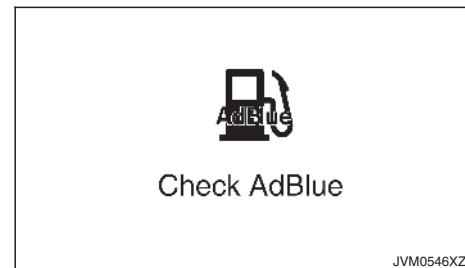

This warning appears if there is a malfunction in the AdBlue® SCR system.

Have the system checked by an approved dealer or qualified workshop as soon as possible.

Condition B

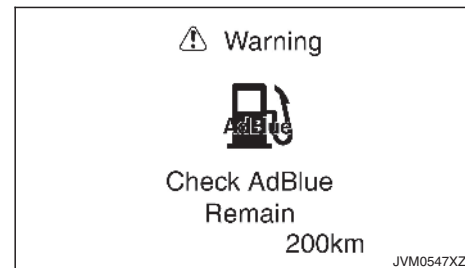

This warning provides you with an estimation of the distance (0 to 1000 km (0 to 621 miles)) that can be driven before inspecting and/or repairing the AdBlue® SCR system.

DIESEL PARTICULATE FILTER (DPF) (where fitted)

Condition C



If this warning appears while the engine is stopped, the engine cannot be started. Contact an approved dealer or qualified workshop.

If this warning appears while the engine is running, the vehicle can still be driven to the nearest approved dealer or qualified workshop.

If the ignition switch is turned off while this warning appears, the engine can be restarted within 3 minutes. Stop the vehicle in a safe place and contact an approved dealer or qualified workshop.

Have the AdBlue® SCR system inspected and/or repaired by an approved dealer or qualified workshop as soon as possible.



WARNING

Be careful not to burn yourself with exhaust gases.

Do not park the vehicle over flammable materials such as dry grass, waste paper or rags, as they may burn easily.

CAUTION

To maintain maximum Diesel Particulate Filter (DPF) performance, follow these precautions:

Use low-sulphur fuel.

Use an engine oil specified by RENAULT. (Refer to the maintenance service booklet for your vehicle.) If an engine oil not a specified by RENAULT is used, it could cause DPF malfunction or reduced fuel efficiency.

Do not modify the DPF, muffler or exhaust pipe. Otherwise it could affect the DPF performance and cause a malfunction.

Do not kick or hit the DPF. The DPF has a built-in catalyst system in the muffler. Such an impact could cause DPF damage.

The Diesel Particulate Filter (DPF) reduces the amount of materials that affect the environment by collecting particulate matter included in exhaust gases. Normally, particulate matter accumulated in the DPF is automatically burned and converted to harmless substances during driving. However, particulate matter collected in the DPF cannot be burned under the following conditions:

When vehicle speed remains below 15 km/h (10 MPH) for a long period of time.

When the engine is frequently stopped and re-started within 10 minutes.

When the vehicle is frequently used for short journeys of 10 minutes or less.

When the engine is frequently stopped before it has warmed up.

In these cases, it becomes difficult to burn particulate matter that has accumulated in the DPF automatically. As a result, the DPF warning light in the meter will illuminate and the indicator light on the DPF regeneration switch will blink. This is not a malfunction.

If the DPF warning light comes on, perform the DPF regeneration process.

CAUTION

If the vehicle continues to be driven with the DPF warning light illuminated and without doing the regeneration process, the fail-safe will limit the engine revolutions and/or torque. In this case, the engine oil must be replaced and the process of service regeneration must be carried out by an approved dealer or qualified workshop.

The service regeneration is not covered by the warranty.

ON-ROAD AND OFF-ROAD DRIVING PRECAUTIONS

AUTOMATIC REGENERATION

If the DPF warning light comes on, it indicates that particulate matter has accumulated in the DPF to the specified limit. Particulate matter collected in the DPF cannot be burned under low speed driving conditions.

As soon as safely possible, drive the vehicle at a high speed (more than approximately 80 km/h (50 MPH)) until the DPF warning light turns off. Always conform to local regulations.

When the accumulated particulate matter has been completely burned, the DPF warning light will turn off.

Pick-up vehicles have a significantly higher roll-over rate than other types of vehicles.

They have higher ground clearance than passenger cars to make them capable of performing in a wide variety of on-pavement and off-road applications. This gives them a higher centre of gravity than ordinary cars. An advantage of higher ground clearance is a better view of the road, allowing you to anticipate problems. However, they are not designed for cornering at the same speeds as conventional passenger cars any more than low-slung sports cars are designed to perform satisfactorily under off-road conditions. If at all possible, avoid sharp turns or abrupt manoeuvres, particularly at high speeds. As with other vehicles of this type, failure to operate this vehicle correctly may result in loss of control or vehicle rollover.

For information about driving using Four-Wheel Drive (4WD) (where fitted), see "Four-Wheel Drive (4WD) (where fitted)" later in this section.

DRIVING SAFETY PRECAUTIONS

Please observe the following precautions:



WARNING

Drive carefully when off the road and avoid dangerous areas. Every person who drives or rides in this vehicle should be seated with their seat belt fastened. This will keep you and your passengers in position when driving over rough terrain.

Do not drive across steep slopes. Instead drive either straight up or straight down the slopes.

Off-road vehicles can tip over sideways much more easily than they can forward or backward.

Many hills are too steep for any vehicle. If you drive up them, you may stall. If you drive down them, you may not be able to control your speed. If you drive across them, you may roll over.

Do not shift ranges while driving on downhill grades as this could cause loss of control of the vehicle.

Stay alert when driving to the top of a hill. At the top there could be a drop-off or other hazard that could cause an accident.

If your engine stalls or you cannot make it to the top of a steep hill, never attempt to turn around. Your vehicle could tip or roll over. Always back straight down in R (Reverse) range. Never back down in N (Neutral) or with the clutch pedal depressed (MT model) using only the brake, as this could cause loss of control.

Heavy braking going down a hill could cause your brakes to overheat and fade, resulting in loss of control and an accident. Apply brakes lightly and use a low range to control your speed.

Unsecured cargo can be thrown around when driving over rough terrain. Properly secure all cargo so it will not be thrown forward and cause injury to you or your passengers.

To avoid raising the centre of gravity excessively, do not exceed the rated capacity of the roof rail (where fitted) and evenly distribute the load. Secure heavy loads in the cargo area as far forward and as low as possible. Do not equip the vehicle with tyres larger than specified in this manual. This could cause your vehicle to roll over.

Do not grip the inside or spokes of the steering wheel when driving off-road. The steering wheel could move suddenly and injure your hands. Instead drive with your fingers and thumbs on the outside of the rim.

Before operating the vehicle, ensure that the driver and all passengers have their seat belts fastened.

Always drive with the floor mats in place as the floor may become hot.

Lower your speed when encountering strong crosswinds. With a higher centre of gravity, your vehicle is more affected by strong side winds. Slower speeds ensure better vehicle control.

Do not drive beyond the performance capability of the tyres, even with 4WD engaged.

Do not attempt to raise two wheels off the ground and shift the transmission to any drive or reverse position with the engine running. Doing so may result in drivetrain damage or unexpected vehicle movement which could result in serious vehicle damage or personal injury.

Do not attempt to test a 4WD equipped vehicle on a 2-wheel dynamometer or similar equipment even if the other two wheels are raised off the ground. Make sure you inform test facility personnel that your vehicle is equipped with 4WD before it is placed on a dynamometer. Using the wrong test equipment may result in drivetrain damage or unexpected vehicle movement which could result in serious vehicle damage or personal injury.

When a wheel is off the ground due to an unlevel surface, do not spin the wheel excessively.

Accelerating quickly, sharp steering manoeuvres or sudden braking may cause loss of control.

If at all possible, avoid sharp turning manoeuvres, particularly at high speeds. Your vehicle has a higher centre of gravity than a conventional passenger car. The vehicle is not designed for cornering at the same speeds as conventional passenger cars. Failure to operate this vehicle correctly could result in loss of control and/or a rollover accident.

Always use tyres of the same type, size, brand, construction (bias, bias-belted or radial), and tread pattern on all four wheels. Install tyre chains on the rear wheels when driving on slippery roads and drive carefully.

Be sure to check the brakes immediately after driving in mud or water. See "Brake system" later in this section for wet brakes.

Avoid parking your vehicle on steep hills. If you get out of the vehicle and it rolls forward, backward or sideways, you could be injured.

Whenever you drive off-road through sand, mud or water as deep as the wheel hub, more frequent maintenance may be required. See the maintenance information in a separate maintenance booklet.

Rinse the underside of the vehicle with fresh water after driving through mud or sand. Remove any brush or sticks that are trapped.

TURBOCHARGER SYSTEM

The turbocharger system uses engine oil for lubrication and cooling of its rotating components. The turbocharger turbine turns at extremely high speeds and it can reach an extremely high temperature. It is essential to maintain a flow of clean oil through the turbocharger system. A sudden interruption to the oil supply may cause a malfunction in the turbocharger.

To ensure prolonged life and performance of the turbocharger, it is essential to comply with the following maintenance procedure:

CAUTION

Change the engine oil of the turbo-charged diesel engine as prescribed. See the separately provided maintenance booklet for additional information.

Use only the recommended engine oil. For details, refer to the maintenance service booklet for your vehicle.

If the engine has been operating at high rpm for an extended period of time, let it idle for a few minutes prior to shutdown.

Do not accelerate the engine to high rpm immediately after starting it.

When starting the engine at ambient temperatures below -5°C (23°F), an engine protection mode may be activated. During this time, the engine output is reduced. The engine protection mode is switched off automatically after a maximum of 3 minutes (provided the accelerator pedal is released completely).

CARE WHEN DRIVING

Driving your vehicle to fit the circumstances is essential for your safety and comfort. As a driver, you should be the one who knows best how to drive in the given circumstances.

ENGINE COLD START PERIOD

Due to the higher engine speeds, when the engine is cold, extra caution must be exercised when selecting a gear during the engine warm-up period after starting the engine.

LOADING LUGGAGE

Loads and their distribution and the attachment of equipment (roof baggage carriers, etc.) will considerably change the driving characteristics of the vehicle. Your driving style and speed must be adjusted according to the circumstances.

DRIVING IN WET CONDITIONS

Avoid accelerating or stopping suddenly.

Avoid sharp turning or lane changing suddenly.

Avoid following too close to the vehicle in front.

When water covers the road surface with water puddles, small water streams, etc., reduce speed to prevent hydroplaning which can cause skidding and loss of control. Worn tyres will increase this risk.

DRIVING IN WINTER CONDITIONS

Drive cautiously.

Avoid accelerating or stopping suddenly.

Avoid sharp turning or lane changing suddenly.

Avoid sudden steering.

Avoid following too close to the vehicle in front.

IGNITION SWITCH (models without Remote Control Key system)



WARNING

Never remove the key or turn the ignition switch to the <LOCK> position while driving. The steering wheel will lock. This will cause the driver to lose control of the vehicle and could result in serious vehicle damage or personal injury.

MANUAL TRANSMISSION (MT)

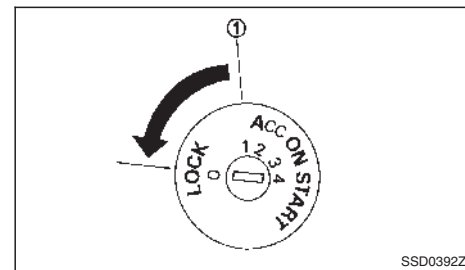

The switch includes an anti-theft steering lock device.

The ignition key can only be removed when the switch is in the <LOCK> normal parking position (0).

There is an "OFF" position ① in between <LOCK> and <ACC>, although it does not show on the lock cylinder.

To lock the steering wheel, remove the key. To unlock the steering wheel, insert the key and turn it gently while rotating the steering wheel slightly right and left.

AUTOMATIC TRANSMISSION (AT)

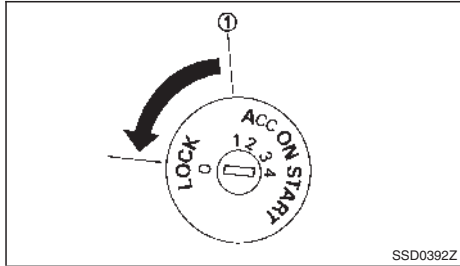

There is an "OFF" position ① between the <LOCK> and <ACC> positions, although it is not marked on the ignition switch.

The ignition lock is designed so that the ignition switch cannot be turned to the <LOCK> position until the shift lever is moved to the P (Park) position. When moving the ignition switch to the <LOCK> position, to remove the key from the ignition switch, make sure the shift lever is in the P (Park) position.

When the ignition switch cannot be turned to the <LOCK> position:

1. Move the shift lever to the P (Park) position.
2. Turn the ignition switch slightly in the <ON> direction.
3. Place the ignition switch in the <LOCK> position.
4. Remove the key.

If the ignition switch is turned to the <LOCK> position, the shift lever cannot be moved from the P

(Park) position. The shift lever can be moved if the ignition switch is in the <ON> position with the foot-brake pedal depressed.

KEY POSITIONS

LOCK (Normal parking position) (0):

The ignition key can only be removed at this position.

OFF (1):

The engine can be turned off without locking the steering wheel.

ACC (Accessories) (2):

This position activates electrical accessories such as the radio when the engine is not running.

ON (Normal operating position) (3):

This position turns on the ignition system and electrical accessories.

START (4):

This position starts the engine. As soon as the engine has started, release the key immediately. It will automatically return to the <ON> position.

STEERING LOCK

Locking the steering wheel

- 1) Place the ignition switch in the <LOCK> position.
- 2) Remove the key from the ignition switch.
- 3) Turn the steering wheel 1/6 of a turn clockwise from the straight up position.

Unlocking the steering wheel

- 1) Insert the key into the ignition switch.

- 2) Gently turn the ignition switch while rotating the steering wheel left and right.

PUSH-BUTTON IGNITION SWITCH (models with Remote Control Key system)

PRECAUTIONS ON PUSH-BUTTON IGNITION SWITCH OPERATION



WARNING

Do not operate the push-button ignition switch while driving the vehicle except in an emergency. (The engine will stop when the ignition switch is pushed 3 consecutive times or the ignition switch is pushed and held for more than 2 seconds.) The steering wheel may lock and could cause the driver to lose control of the vehicle. This could result in serious vehicle damage or personal injury.

REMOTE CONTROL KEY SYSTEM

The Remote Control Key system can operate the ignition switch without taking the key out from your pocket or bag. The operating environment and/or conditions may affect the Remote Control Key system operation.

Some indicators and warnings for operation are displayed in the vehicle information display and/or in the meter. (See "Warning lights, indicator lights and audible reminders" in the "2. Instruments and controls" section and "Vehicle information display" in the "2. Instruments and controls" section.)

CAUTION

Be sure to carry the Remote Control Key with you when operating the vehicle.

Never leave the Remote Control Key inside the vehicle when you leave the vehicle.

If the vehicle battery is discharged, the ignition switch cannot be switched from the "LOCK" position, and if the steering lock is engaged, the steering wheel cannot be moved. Charge the battery as soon as possible. (See "Remote Control Key battery replacement" in the "8. Maintenance and do-it-yourself" section.)

Operating range

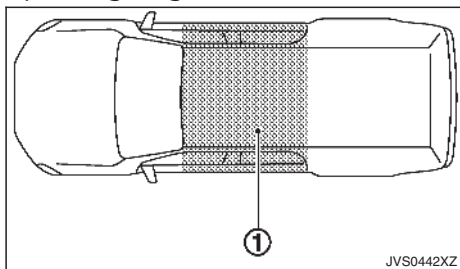

The Remote Control Key can only be used for starting the engine when the Remote Control Key is within the specified operating range ① as illustrated.

When the Remote Control Key battery is almost discharged or strong radio waves are present near the operating location, the Remote Control Key system's operating range becomes narrower and may not function properly.

If the Remote Control Key is within the operating range, it is possible for anyone, even someone who does not carry the Remote Control Key, to push the ignition switch to start the engine.

The cargo bed area is not included in the operating range of the engine start function.

If the Remote Control Key is placed on the instrument panel, inside the glove box, door pocket or the corner of the interior compartment, the Remote Control Key may not function.

If the Remote Control Key is placed near the door or window outside the vehicle, the Remote Control Key may function.

AUTOMATIC TRANSMISSION (AT)

The ignition lock is designed so that the ignition switch cannot be switched to the "LOCK" position until the shift lever is moved to the P (Park) position. When pushing the ignition switch to the "OFF" position, make sure the shift lever is in the P (Park) position.

When the ignition switch cannot be switched to the "LOCK" position:

1. [Shift to Park] warning appears on the vehicle information display and a chime sounds.
2. Move the shift lever to the P (Park) position.
3. If the ignition switch is in the "ACC" position, [PUSH] warning appears on the vehicle information display.
4. Push the ignition switch. The ignition switch is switched to the "OFF" position.
5. Open the door. The ignition switch turns to the "LOCK" position.

For warnings and indicators on the vehicle information display, see "Indicators for operation" in the "2. Instruments and controls" section.

If the ignition switch is switched to the "LOCK" position, the shift lever cannot be moved from the P (Park) position. The shift lever can be moved if the ignition switch is in the "ON" position with the foot-brake pedal depressed.

STEERING LOCK

The ignition switch is equipped with an anti-theft steering lock device.

To lock steering wheel

1. Place the ignition switch in the "OFF" position where the ignition switch position indicator will not illuminate.
2. Open or close the door. The ignition switch turns to the "LOCK" position.
3. Turn the steering wheel 1/6 of a turn to the right or left from the straight up position.

To unlock steering wheel

Push the ignition switch, and the steering wheel will be automatically unlocked.

CAUTION

If the battery of the vehicle is discharged, the push-button ignition switch cannot be switched from the "LOCK" position.

If the steering lock release malfunction indicator (where fitted) appears in the vehicle information display, push the ignition switch again while rotating the steering wheel slightly to the right and left. (See "Vehicle information display" in the "2. Instruments and controls" section.)

IGNITION SWITCH POSITIONS



WARNING

Never place the ignition switch in the "OFF" position while driving. The steering wheel may lock and cause the driver to lose control of the vehicle, resulting in serious vehicle damage or personal injury.

CAUTION

Do not leave the vehicle for extended periods of time when the ignition switch is in the "ON" position and the engine is not running. This can discharge the battery.

Use electrical accessories with the engine running to avoid discharging the vehicle battery. If you must use accessories while the engine is not running, do not use them for extended periods of time and do not use multiple electrical accessories at the same time.

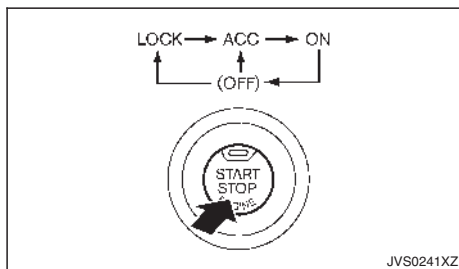

When the ignition switch is pushed without depressing the brake pedal (automatic transmission model) or the clutch pedal (manual transmission model), the ignition switch position will change as follows:

Push once to change to "ACC".

Push two times to change to "ON".

Push three times to change to "OFF".

Push four times to return to "ACC".

Open or close any door to return to "LOCK" from the "OFF" position.

LOCK position

The ignition switch and steering lock can only be locked at this position.

The ignition switch will be unlocked when it is pushed to the "ACC" position while carrying the Remote Control Key.

ACC position

The electrical accessory power activates at this position without the engine turned on.

ON position

The ignition system and the electrical accessory power activate at this position without the engine turned on.

OFF position

The engine is turned off with the steering wheel unlocked.

REMOTE CONTROL KEY BATTERY DISCHARGE

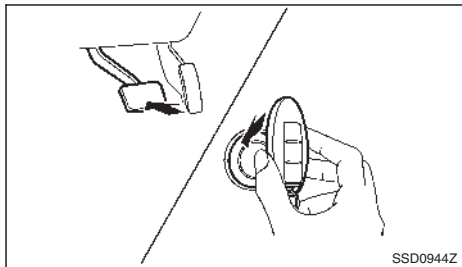

If the battery of the Remote Control Key is discharged, or environmental conditions interfere with the Remote Control Key operation, start the engine according to the following procedure:

1. **Automatic Transmission (AT) model:**

Move the shift lever to the P (Park) position.

Manual Transmission (MT) model:

Move the shift lever to the N (Neutral) position.

2. Firmly depress the brake pedal.
3. Touch the ignition switch with the Remote Control Key as illustrated. (A chime will sound.)
4. Push the ignition switch while depressing the brake pedal (AT model) or the clutch pedal (MT model) within 10 seconds after the chime sounds. The engine will start.

After step 3 is performed, when the ignition switch is pushed without depressing the brake pedal (AT model) or the clutch pedal (MT model), the ignition switch position will change to "ACC".

NOTE

When the ignition switch is pushed to the "ACC" or "ON" position or the engine is started by the above procedures, the Key Battery low warning appears on the vehicle information display even if the Remote Control Key is inside the vehicle. This is not a malfunction. To turn off the warning, touch the ignition switch with the Remote Control Key again.

If the Key Battery low warning appears on the vehicle information display, replace the battery as soon as possible. (See "Remote Control Key battery replacement" in the "8. Maintenance and do-it-yourself" section.)

STARTING ENGINE (models without Remote Control Key system)

1. Apply the parking brake.
2. Depress the footbrake pedal.
3. **Automatic Transmission (AT) model:**

Move the shift lever to the P (Park) or the N (Neutral) position.

The starter is designed to operate only when the shift lever is in the proper position.

Manual Transmission (MT) model:

Move the shift lever to the N (Neutral) position and depress the clutch pedal to the floor while starting the engine.

4. Crank the engine with your foot off the accelerator pedal by placing the ignition switch in the <START> position.

Place the ignition switch in the <ON> position and wait until the glow plug indicator light  turns off.

5. Immediately release the ignition switch when the engine starts. If the engine starts, but fails to run, repeat the above procedures.
6. Allow the engine to idle for at least 30 seconds after starting the engine to warm-up. Drive at moderate speeds for a short distance first, especially in cold weather.

CAUTION

Do not leave the vehicle unattended while the engine is warming up.

STARTING ENGINE (models with Remote Control Key system)

1. Apply the parking brake.
2. **Automatic Transmission (AT) model:**
Move the shift lever to the P (Park) or the N (Neutral) position.
The starter is designed to operate only when the shift lever is in the proper position.
Manual Transmission (MT) model:
Move the shift lever to the N (Neutral) position.
The Remote Control Key must be carried when operating the ignition switch.
3. Place the ignition switch in the "ON" position. Depress the brake pedal (AT model) or the clutch pedal (MT model) and push the ignition switch to start the engine.
For diesel engine models: Wait until the glow plug indicator light  goes out.
To start the engine immediately, push and release the ignition switch while depressing the brake pedal or clutch pedal with the ignition switch in any position.
4. Immediately release the ignition switch when the engine starts. If the engine starts, but fails to run, repeat the above procedures.
5. Allow the engine to idle for at least 30 seconds after starting the engine to warm-up. Drive at moderate speeds for a short distance first, especially in cold weather.

CAUTION

Do not leave the vehicle unattended while the engine is warming up.

6. To stop the engine, move the shift lever to the P (Park) (AT model) or N (Neutral) (MT model) position, apply the parking brake, and place the ignition switch in the "OFF" position.

DRIVING THE VEHICLE

DRIVING WITH AUTOMATIC TRANSMISSION (AT)

The Automatic Transmission (AT) in your vehicle is electronically controlled to produce maximum power and smooth operation.

The recommended operating procedures for this transmission are shown on the following pages. Follow these procedures for maximum vehicle performance and driving enjoyment.



WARNING

Do not downshift abruptly on slippery roads. This may cause a loss of control.

CAUTION

The cold engine idle speed is high, so use caution when shifting into a forward or reverse gear before the engine has warmed up.

Avoid revving up the engine while the vehicle is stopped. This could cause unexpected vehicle movement.

Never shift to either the P (Park) or R (Reverse) position while the vehicle is moving forward and P (Park) or D (Drive) position while the vehicle is reversing. This could cause an accident or damage the transmission.

Except in an emergency, do not shift to the N (Neutral) position while driving. Coasting with the transmission in the N (Neutral) position may cause serious damage to the transmission.

Start the engine in either the P (Park) or N (Neutral) position. The engine will not start in any other gear position. If it does, have your vehicle checked by an approved dealer or qualified workshop.

Shift into the P (Park) position and apply the parking brake when at a standstill for longer than a short waiting period.

Keep the engine at idling speed while shifting from the N (Neutral) position to any driving position.

To avoid possible damage to your vehicle; when stopping the vehicle on an uphill grade, do not hold the vehicle by depressing the accelerator pedal. The footbrake should be used for this purpose.

Starting vehicle

1. After starting the engine, fully depress the footbrake pedal before attempting to move the shift lever out of the P (Park) position.
2. Keep the footbrake pedal depressed and move the shift lever into a driving position.
3. Release the parking brake, the footbrake pedal, and then gradually start the vehicle in motion.

The AT is designed so the footbrake pedal **MUST** be depressed before shifting from the P (Park) position to any driving position while the ignition switch is in the "ON" position.

The shift lever cannot be moved out of the P (Park) position and into any of the other gear positions if the ignition switch is placed in the "LOCK", "OFF" or "ACC" position.

CAUTION

DEPRESS THE FOOTBRAKE PEDAL - Shifting the shift lever to D (Drive), R (Reverse), or manual shift mode without depressing the footbrake pedal causes the vehicle to move slowly when the engine is running. Make sure the footbrake pedal is depressed fully and the vehicle is stopped before shifting the shift lever.

MAKE SURE OF THE SHIFT LEVER POSITION - Make sure the shift lever is in the desired position. D (Drive) and manual shift mode are used to move forward and R (Reverse) to reverse. Depress the accelerator pedal to start the vehicle and merge with traffic (avoid abrupt starting and spinning the wheels).

WARM UP THE ENGINE - Due to the higher idle speeds when the engine is cold, extra caution must be exercised when shifting the shift lever into the driving position immediately after starting the engine.

PARKING THE VEHICLE - Depress the footbrake pedal and, once the vehicle stops, move the shift lever into the P (Park) position, pull the parking brake lever and release the footbrake pedal.

Shifting

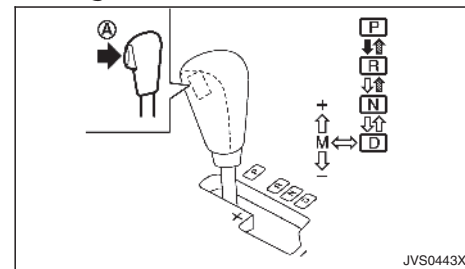

	Push the button A while depressing the footbrake pedal
	Push the button A
	Just move the shift lever

WARNING

Apply the parking brake if the shift lever is in any position while the engine is not running. Failure to do so could cause the vehicle to move unexpectedly or roll away and result in serious personal injury or property damage.

If the shift lever cannot be moved from the P (Park) position while the engine is running and the footbrake pedal is depressed, the stop lights may not work. Malfunctioning stop lights could cause an accident injuring yourself and others.

After starting the engine, fully depress the footbrake pedal, push the shift lever button and move the shift lever out of the P (Park) position.

If the ignition switch is placed in the "OFF" or "ACC" position for any reason while the shift lever is in any positions other than the P (Park) position, the ignition switch cannot be placed in the "LOCK" position.

If the ignition switch cannot be placed in the "LOCK" position, perform the following steps:

1. Apply the parking brake.
2. Place the ignition switch in the "ON" position while depressing the footbrake pedal.
3. Move the shift lever to the P (Park) position.
4. Place the ignition switch in the "LOCK" position.

P (Park):

Use this position when the vehicle is parked or when starting the engine. **Make sure that the vehicle is completely stopped and move the shift lever into the P (Park) position.** Apply the parking brake. When parking on a hill, first depress the footbrake pedal, apply the parking brake, and then move the shift lever into the P (Park) position.

R (Reverse):

Use this position to reverse. Make sure that the vehicle is completely stopped before selecting the R (Reverse) position.

N (Neutral):

Neither the forward nor reverse gear is engaged. The engine can be started in this position. You may shift to the N (Neutral) position and restart a stalled engine while the vehicle is moving.

D (Drive):

Use this position for all normal forward driving.

Manual shift mode

When the shift lever is shifted to the manual shift gate and moved up or down while driving, the transmission enters the manual shift mode. Shift range can be selected manually.

When shifting up, move the shift lever to the + (up) side. The transmission shifts to the higher range.

When shifting down, move the shift lever to the - (down) side. The transmission shifts to the lower range.

When cancelling the manual shift mode, return the shift lever to the "D" (Drive) position. The transmission returns to the normal driving mode.

In the manual shift mode, the shift range is displayed in the vehicle information display between the speedometer and tachometer.

Shift ranges up or down one by one as follows:

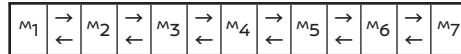

M₇ (7th):

Use this position for all normal forward driving at highway speeds.

M₆ (6th) and M₅ (5th):

Use these positions when driving up long slopes, or for engine braking when driving down long slopes.

M₄ (4th), M₃ (3rd) and M₂ (2nd):

Use these positions for hill climbing or engine braking on downhill grades.

M₁ (1st):

Use this position when climbing steep hills slowly or driving slowly through deep snow, or for maximum engine braking on steep downhill grades.

Remember not to drive at high speeds for extended periods of time in lower than 7th gear. This reduces fuel economy.

Moving the shift lever to the same side twice will shift the ranges in succession. However, if this motion is rapidly done, the second shifting may not be completed properly.

In the manual shift mode, the transmission may not shift to the selected gear or may automatically shift to the other gear. This helps maintain driving performance and reduces the chance of vehicle damage or loss of control.

When the transmission does not shift to the selected gear, the Automatic Transmission (AT) position indicator light (in the vehicle information display) will blink and the buzzer will sound.

In the manual shift mode, the transmission automatically shifts down to 1st gear before the vehicle comes to a stop. When accelerating again, it is necessary to shift up to the desired range.

Accelerator downshift - in D (Drive) position

For passing or climbing hills, depress the accelerator pedal to the floor. This shifts the transmission down into a lower gear, depending on the vehicle speed.

Shift lock release

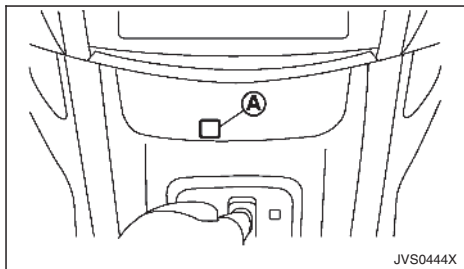

If the battery is discharged, the shift lever may not be moved from the P (Park) position even with the brake pedal depressed.

To release the shift lock, perform the following procedure:

1. Place the ignition switch in the "OFF" or "LOCK" position.
2. Apply the parking brake.
3. Remove the shift lock cap (A) and push down the shift lock release button.
4. Push and hold the shift lever button and move the shift lever to the N (Neutral) position while holding down the shift lock release button (A).

Place the ignition switch in the "ON" position to release the steering wheel lock.

The vehicle may be moved, by pushing, to the desired location.

If the shift lever cannot be moved out of the P (Park) position, have an approved dealer or qualified workshop check the AT system as soon as possible.

Fail-safe

When the fail-safe operation occurs, the AT will be locked in any of the forward gears depending on conditions.

If the vehicle is driven under extreme conditions, such as excessive wheel spinning and subsequent hard braking, the fail-safe system may be activated. This will occur even if all electrical circuits are functioning properly. In this case, place the ignition switch in the "OFF" position and wait for 3 seconds. Then place the ignition switch back in the "ON" position. The vehicle should return to its normal operating condition. If it does not return to its normal operating condition, have an approved dealer or qualified workshop check the transmission and repair it if necessary.

DRIVING WITH MANUAL TRANSMISSION (MT)



WARNING

Do not downshift abruptly on slippery roads. This may cause a loss of control.

Do not over-rev the engine when shifting to a lower gear. This may cause a loss of vehicle control or engine damage.

CAUTION

Do not rest your foot on the clutch pedal while driving. This may damage the clutch system.

Fully depress the clutch pedal before shifting to help prevent transmission damage.

Stop the vehicle completely before shifting into the R (Reverse) position.

When the vehicle is stopped for a period of time, for example, waiting at stoplights, shift to the N (Neutral) position and release the clutch pedal with the footbrake pedal depressed.

Starting vehicle

1. After starting the engine, depress the clutch pedal to the floor and move the shift lever to the 1 (1st), 2 (2nd) or R (Reverse) position. RENAULT recommends to start the vehicle in 2nd gear on level, flat ground and in the unladen condition.
2. Slowly depress the accelerator pedal, releasing the clutch pedal and parking brake at the same time.

Shifting gear

To change gears, or when upshifting or downshifting, fully depress the clutch pedal, shift into the appropriate gear, then slowly and smoothly release the clutch pedal.

Start the vehicle in the 1 (1st) or 2 (2nd) position and shift to the 3 (3rd), 4 (4th), 5 (5th) and 6 (6th) gear in sequence according to the vehicle speed.

If it is difficult to move the shift lever into the R (Reverse) or 1 (1st) position, shift to the N (Neutral) position, and then release the clutch pedal once. Fully depress the clutch pedal again and shift into R or 1.

STOP/START SYSTEM (where fitted)

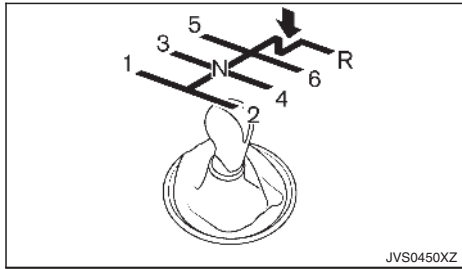

To reverse, depress the shift lever and then move it to the R (Reverse) position after the vehicle has completely stopped.

The Stop/Start System is designed to prevent unnecessary fuel consumption, exhaust emissions, and noise during a journey:

When you stop the vehicle with the shift lever in N (Neutral) and clutch pedal released, the engine is turned off automatically.

When you push the clutch pedal, the engine is automatically turned on.

CAUTION

At the end of the journey the engine must be stopped and ignition turned off. Lock the vehicle as normal. Turning the ignition switch OFF will shut down all electrical systems. Failure to do this may result in a flat battery.

NOTE

For model with Stop/Start System, use the special battery that is enhanced in regard to the charge-discharge capacity and life performance. Avoid using a non-special battery for the Stop/Start System, as this may cause early deterioration of the battery or a malfunction of the Stop/Start System. For the battery, it is recommended to use Genuine RENAULT parts. For more information, contact an approved dealer or qualified workshop.

NOTE

The Stop/Start System will not activate under the following conditions:

When the engine is kept idling without any driving after the engine is turned on.

When the engine coolant temperature is low.

When the battery capacity is low.

When the battery temperature is low.

When the vehicle is moved.

When the vacuum in the brake servo decreases.

When the engine bonnet is opened with the engine running.

When the engine is turned on with the engine bonnet open.

When the driver's seat belt is not fastened.

When the driver's door is open.

When the Stop/Start System indicator blinks at a low speed.

When the fan speed control is in any position other than OFF (0) while the air flow control is in the front defogger position.

When the front defogger switch is on.

When the temperature inside the vehicle is too high or low. (When the Auto air conditioning system is off, the Stop/Start System will operate.)

When the fan speed of the air conditioner is set to the maximum speed.

When the Stop/Start OFF switch is turned on.

When the power consumption is large.

When the vehicle is travelling at altitudes higher than 2000 m (6562 ft) (MT model).

For Manual Transmission (MT) models

When the shift lever is in any position except the N (Neutral) position.

When the clutch pedal is depressed.

When the Remote Control Key is not in the vehicle.

When the steering wheel is turning or turned more than 45 degrees.

NOTE

The engine will not restart even if the clutch pedal is pressed while the Stop/Start System is activated under the following condition:

When the engine bonnet is opened.

When the driver seat belt is unfastened and the driver's door is opened.

When the shift lever is not in the N (Neutral) position.

NOTE

It may take some time until the Stop/Start System activates under the following conditions:

When the battery is discharged.

When the outside temperature is low or high.

When the battery is replaced or the battery terminal is disconnected for extended periods and then reconnected.

NOTE

When the Stop/Start System indicator illuminates, the engine starts running automatically under at least one of the following conditions:

The battery voltage becomes low (due to electrical load from other vehicle systems like headlights, heaters, etc., or auxiliary devices connected to the 12 volt socket inside the vehicle).

The vehicle speed is above about 2 km/h (1 MPH).

The front defogger is operated.

When the temperature inside the vehicle is too high or low. (When the air conditioner is off, the Stop/Start System will operate.)

When the front defogger is turned on. (The engine may not start depending on the outside temperature.)

When the battery capacity is low.

When the power consumption is high.

When the clutch pedal is depressed.

CAUTION

Only engage gear when the clutch pedal is fully depressed.

NOTE

The following conditions will prevent the Stop/Start System from automatically restarting the engine. Starting the engine with the ignition switch operation is then necessary:

The driver's seat belt is unfastened, and driver's door is open.

The bonnet is open.

Use this system while waiting at stoplight, etc. When the vehicle is stopped for long periods of time, turn off the engine.

When the engine is stopped by the Stop/Start System, heating, cooling and dehumidifying functions will be deactivated. To avoid the air conditioning functions from being deactivated, turn off the Idling Stop mode by pressing the Stop/Start OFF switch.

STOP/START SYSTEM DISPLAY

Engine stop

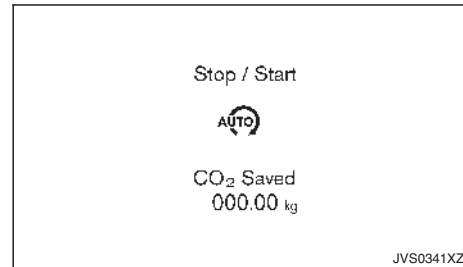

When the engine is stopped the information is displayed for a few seconds.

Stop/Start System ON or OFF

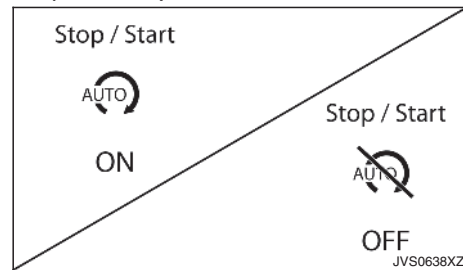

If the Stop/Start System is activated or deactivated using the Stop/Start System OFF switch, the message is shown.

CO2 or fuel saved and engine stop time

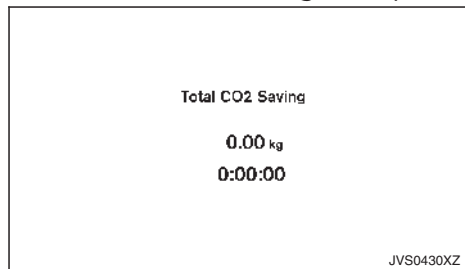

The CO2 or fuel saved and the engine stop time mode shows the following items:

The CO2 saved shows the estimated quantity of CO2 exhaust emissions that were prevented by the Stop/Start System every time the engine is automatically stopped.

The engine stop time shows the time that the engine has been stopped for by the Stop/Start System.

For more information, see "Stop/Start System (where fitted)" earlier in this section.

Auto start deactivation



If the engine stops when the Stop/Start System is activated, and will not start automatically, the message is shown.

Key LOCK warning

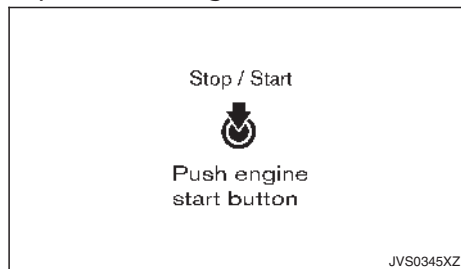

The information is displayed and a buzzer sounded to remind the driver to turn the ignition switch OFF to avoid a flat battery.

The message can only be cleared by turning or pushing the ignition switch OFF (or restarting the engine).

System fault

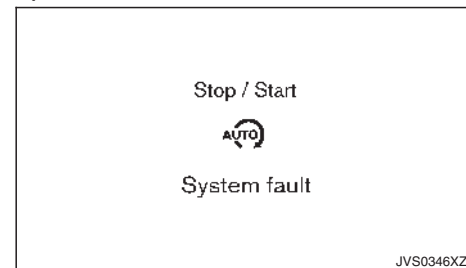

This message is displayed when the Stop/Start System is malfunctioning.

Have the system checked by an approved dealer or qualified workshop.

FOUR-WHEEL DRIVE (4WD) (where fitted)

STOP/START OFF SWITCH

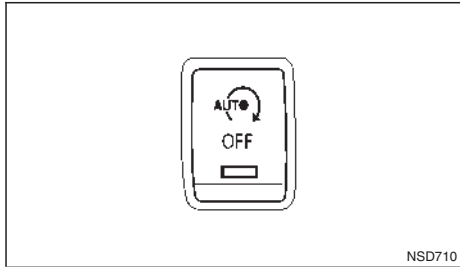

The system can be temporarily deactivated by pressing the Stop/Start OFF switch. Pressing the switch again or restarting the engine by using the ignition switch will reactivate the Stop/Start System.

When the Stop/Start System is deactivated while the engine is running, the engine is prevented from automatically stopping.

When the Stop/Start System is deactivated after the engine has been automatically stopped by the Stop/Start System, the engine will immediately restart if suitable conditions are present. The engine will then be prevented from automatically stopping during the same journey.

Whenever the Stop/Start System is deactivated the indicator light ① on the Stop/Start OFF switch illuminates. In this condition the Stop/Start System cannot prevent unnecessary fuel consumption, exhaust emissions, or noise during your journey.

If the Stop/Start System is malfunctioning, the indicator light ① on the Stop/Start OFF switch illuminates.

NOTE

The Stop/Start System ON or OFF messages displayed for a few seconds in the vehicle information display when the Stop/Start OFF switch is pressed. See "Stop/Start System display" earlier in this section.



WARNING

Do not attempt to raise two wheels off the ground and shift the transmission to any drive or reverse position with the engine running. Doing so may result in drivetrain damage or unexpected vehicle movement which could result in serious vehicle damage or personal injury.

Do not attempt to test a 4WD equipped vehicle on a 2-wheel dynamometer or similar equipment even if the other two wheels are raised off the ground. Make sure you inform test facility personnel that your vehicle is equipped with 4WD before it is placed on a dynamometer. Using the wrong test equipment may result in drivetrain damage or unexpected vehicle movement which could result in serious vehicle damage or personal injury.

CAUTION

Do not drive the vehicle in the <4H> or <4LO> position on dry hard surface roads. Driving on dry, hard surfaces in <4H> or <4LO> may cause unnecessary noise, tyre wear and increased fuel consumption.

If the Four-Wheel Drive (4WD) warning light turns on when driving on dry hard surface roads:

- in the <4H> position, shift the 4WD mode switch to <2WD>.

- in the <4LO> position, stop the vehicle and shift the transmission lever to the N (Neutral) position with the brake pedal depressed and shift the 4WD mode switch to <2WD>.

If the 4WD warning light is still on after the above operation, have your vehicle checked by an approved dealer or qualified workshop as soon as possible.

The transfer case may be damaged if you continue driving with the 4WD warning light blinking.

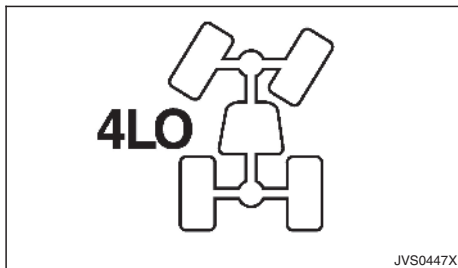

4WD mode indicator



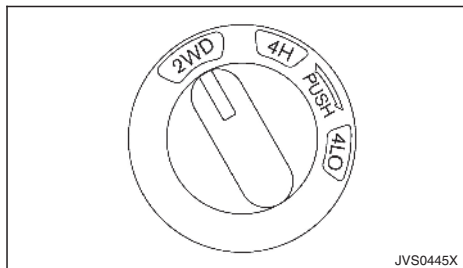

See "On-road and off-road driving precautions" earlier in this section for other precautions.

PART TIME 4WD SYSTEM

The part time 4WD system provides three drive modes: <2WD>, <4H> and <4LO>. The desired drive mode can be selected using the 4WD mode switch according to the driving conditions.



4WD mode switch

4WD mode switch	Wheels driven	Indicator		Use conditions	Operation of 4WD mode switch (See "4WD mode switch operation" later in this section.)
		4WD mode	<4LO>		
<2WD>	Rear wheels		-	For driving on dry, paved roads.	Shifting between the <2WD> and <4H> drive modes can be done while driving. The indicator will change when the drive mode is changed.
<4H>	Four wheels		-	For driving on rough, sandy or snow-covered roads.	
<4LO>	Neutral		Blinking	The 4LO indicator blinks when shifting between <4H> and <4LO>.	Shifting between the <4H> and <4LO> drive modes: Stop the vehicle, depress the, clutch pedal (MT models) and the, brake pedal and shift the shift lever to the N (Neutral) position. Depress and turn the 4WD mode switch. The 4WD mode switch will not shift between <4H> and <4LO> if the transmission is not in the N (Neutral) position or the vehicle is moving. Wait for the 4LO indicator to stop blinking and stay on or off before shifting your transmission into gear or releasing the clutch pedal (MT models).
	Four wheels		Stay on*	For use when maximum power and traction are required at low speeds (for example, on steep grades or rocky, sandy, muddy roads).	

*: When the <4LO> position is selected, the ESP system is disabled and the ESP off indicator light illuminates. See "Warning lights, indicator lights and audible reminders" in the "2. Instruments and controls" section.



WARNING

AT model: If the 4WD mode indicator is "OFF" or the ATP warning light is "ON", this indicates that the automatic transmission P (Park) position will not function and could result in the vehicle moving unexpectedly, causing serious personal injury or property damage. Always set the parking brake.

CAUTION

To avoid vehicle damage:

Do not operate the 4WD mode switch when cornering, reversing or if the rear wheels are spinning freely. The vehicle must be moving straight ahead.

Do not move the shift lever (AT model) or release the clutch pedal (MT model) when the 4LO indicator is blinking. Failure to do this may cause the gears to grind and damage the powertrain.

MT model: Do not accelerate rapidly from a stopped position when the 4LO indicator is blinking. Drive straight ahead at a low speed until the 4LO indicator is lit. The 4LO indicator blinks when shifting between <4LO> and <4H>.

If the 4WD warning light comes on, perform the following procedure:

- 1) Turn off the engine.
- 2) Start the engine.
- 3) Check if the 4WD warning light comes on.

If the 4WD warning light is still on after following the above procedure, have the system checked and serviced immediately by an approved dealer or qualified workshop.

The transfer case 4WD mode switch is used to select either Two-Wheel Drive (2WD) or Four-Wheel Drive (4WD) depending on the driving conditions. Turn the 4WD mode switch to select a drive mode (<2WD>, <4H> or <4LO>).

To change into or out of 4LO mode:

1. The vehicle MUST BE standing still.
2. Depress the clutch pedal (MT model) and the brake pedal and move the shift lever to N (Neutral) (MT model) or to the P (Park) position (AT model).
3. Depress and turn the 4WD mode switch to change into or out of <4LO>.



WARNING

When parking, apply the parking brake before stopping the engine and make sure that the 4WD mode indicator is on and that the ATP warning light or ATP warning message is off, otherwise, the vehicle could unexpectedly move even if the automatic transmission is in the P (Park) position.

The 4LO indicator must stop blinking and remain on or turn off before shifting the transmission into gear. The vehicle may move unexpectedly if the shift lever is shifted from the N (Neutral) position to any other gear while the 4LO indicator is blinking.

CAUTION

Never turn the 4WD mode switch between <4LO> and <4H> while driving.

The <4H> drive mode provides greater power and traction. Avoid excessive speed as it will cause increased fuel consumption and higher oil temperatures, and could damage power train components. Speeds over 100 km/h (60 MPH) in <4H> are not recommended.

The <4LO> drive mode provides maximum power and traction. Avoid raising vehicle speed excessively. The maximum speed is approximately 50 km/h (30 MPH).

The 4WD mode switch can be turned between <2WD> and <4H> while driving straight ahead. Do not turn the 4WD mode switch while making a turn or reversing.

Do not turn the 4WD mode switch between <2WD> and <4H> while driving on steep downhill grades. Use the engine brake and low transmission gears for engine braking.

Do not turn the 4WD mode switch between <2WD> and <4H> with the rear wheels spinning.

Do not drive the vehicle in <4H> or <4LO> mode on dry, hard surfaced roads. This may cause unnecessary noise and tyre wear. RENAULT recommends driving in 2WD under these conditions.

It is not possible to shift the 4WD transfer case between <4H> and <4LO> at low ambient temperatures when the engine is cold. Doing so may cause the 4LO indicator to blink. Wait until the 4WD transfer case has reached operational temperature (after driving for a while) before using the 4WD mode switch to change between <4H> and <4LO>.

When driving on rough roads

Set the 4WD mode switch to <4H> or <4LO>.

Drive carefully and according to the road surface conditions.

If the vehicle gets stuck

Place stones or wooden blocks under the tyres to free the vehicle.

Set the 4WD mode switch to <4H> or <4LO>.

If it is difficult to free the vehicle, drive the vehicle forwards and backwards to increase the momentum. If the vehicle is stuck deep in mud, tyre chains may be effective.

CAUTION

Do not spin the wheels excessively. The wheels will sink deep into the mud and it will be difficult to free the vehicle from the mud.

Avoid shifting gears with the engine running at high speeds as this may cause a malfunction.

4WD MODE SWITCH OPERATION

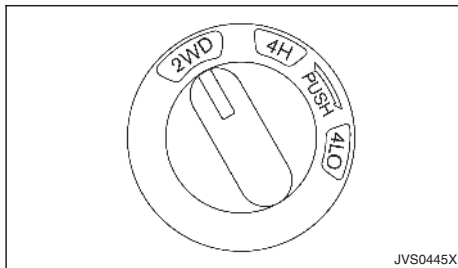

Set the 4WD mode switch to <2WD>, <4H> or <4LO>, depending on driving conditions.

You may feel a slight vehicle movement if the 4WD mode switch is operated while making a turn, accelerating or decelerating, or if the ignition switch is placed in the "OFF" position while the 4WD mode switch is set to <4H> or <4LO>. This is normal.

CAUTION

The 4WD mode switch can be turned between <2WD> and <4H> while driving straight ahead. Do not turn the 4WD mode switch while making a turn or reversing.

Do not operate the 4WD mode switch while driving on steep downhill grades. Use the engine brake by setting a low transmission gear.

Do not operate the 4WD mode switch with the rear wheels spinning.

Before turning the 4WD mode switch to <4H> from <2WD>, make sure that the vehicle speed is less than 100 km/h (60 MPH). Failure to do so can damage the 4WD system.

Never turn the 4WD mode switch between <4LO> and <4H> while driving.

4WD MODE INDICATOR

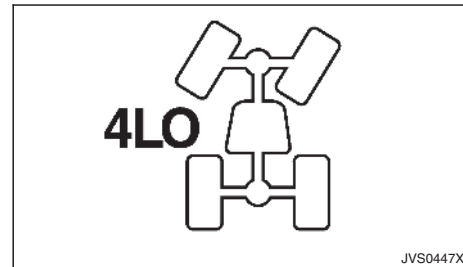

The 4WD mode indicator is displayed in the vehicle information display.



While the engine is running, the 4WD mode indicator will illuminate the position selected by the 4WD mode switch.

The 4WD mode indicator may blink while shifting from one drive mode to the other. When the shifting is completed, the 4WD mode indicator will come on. If the indicator does not come on immediately, make sure the area around the vehicle is safe, and drive the vehicle straight, accelerate or decelerate or move the vehicle in reverse, then shift the 4WD mode switch.

If the 4WD warning light comes on or 4WD Error warning (where fitted) appears, the 4WD mode indicator turns off.

4WD WARNING

Warning light

Warning light		Comes on or blinks when:
	Illuminates	There is a malfunction in the 4WD system
	Blinks	The difference in wheel rotation is large

If the 4WD warning light comes on, the 4WD mode indicator turns off.

A large difference between the diameters of front and rear wheels will make the 4WD warning light blink. Change the 4WD mode switch to <2WD> and do not drive fast.

CAUTION

If the 4WD warning light comes on or blinks during operation for a while, have your vehicle checked by an approved dealer or qualified workshop as soon as possible.

Shifting between <4H> and <4LO> is not recommended when the 4WD warning light turns on.

When the 4WD warning light comes on, the 2WD mode may be engaged even if the 4WD mode switch is in <4H>. Be especially careful when driving. If corresponding parts are malfunctioning, the 4WD mode will not be engaged even if the 4WD mode switch is shifted.

Do not drive the vehicle in the <4H> or <4LO> position on dry hard surface roads. Driving on dry, hard surfaces in <4H> or <4LO> may cause unnecessary noise, tyre wear and increased fuel consumption.

If the Four-Wheel Drive (4WD) warning light turns on when driving on dry hard surface roads:

- in the <4H> position, shift the 4WD mode switch to <2WD>.
- in the <4LO> position, stop the vehicle and shift the transmission lever to the N (Neutral) position with the brake pedal depressed and shift the 4WD mode switch to <2WD>.

If the 4WD warning light is still on after the above operation, have your vehicle checked by an approved dealer or qualified workshop as soon as possible.

The transfer case may be damaged if you continue driving with the warning light blinking.

Warning indicator

If any malfunction occurs in the Four-Wheel Drive (4WD) system while the engine is running, a warning message appears in the vehicle information display.

If the [4WD system fault] warning appears, there may be a malfunction in the 4WD system. Reduce vehicle speed and have your vehicle checked by an approved dealer or qualified workshop as soon as possible.

CAUTION

Do not operate the engine on a free roller when any of the wheels raised.

If the [4WD system fault] warning appears while driving, there may be a malfunction in the 4WD system. Reduce the vehicle speed and have your vehicle checked by an approved dealer or qualified workshop as soon as possible. Be especially careful when driving.

The power train may be damaged if you continue driving with the [4WD system fault] warning on.

TYRE RECOMMENDATION FOR 4WD

CAUTION

Always use tyres of the same size, brand, construction (bias, bias-belted or radial), and tread pattern on all four wheels. Failure to do so may result in a circumference difference between tyres on the front and rear axles, which will cause excessive tyre wear and may damage the transmission, transfer case and differential gears.

ONLY use spare tyres specified for the Four-Wheel Drive (4WD) models.

REAR DIFFERENTIAL LOCKING SYSTEM (where fitted)

If excessive tyre wear is found, it is recommended that all four tyres be replaced with tyres of the same size, brand, construction and tread pattern. The tyre pressure and wheel alignment should also be checked and corrected as necessary. Contact an approved dealer or qualified workshop.

Snow tyres

If you install snow tyres, they must also be of the same size, brand, construction and tread pattern on all four wheels.

Tyre inflation pressure

Periodically check the pressures of all tyres, including the spare, with a gauge while at a service station. If necessary, adjust to the specified pressure. Tyre pressures are shown on the tyre placard affixed to the driver's side centre pillar or rear access door.

Tyre rotation

RENAULT recommends that tyres should be rotated every 5,000 km (3,000 miles).

Snow chains

Snow chains must be installed only on the rear wheels and not on the front wheels.

Do not drive with snow chains on paved roads that are clear of snow. Driving with chains in such conditions can cause damage to the various mechanisms of the vehicle due to overstress. When driving on clear paved roads, be sure to change to Two-Wheel Drive (2WD) mode.

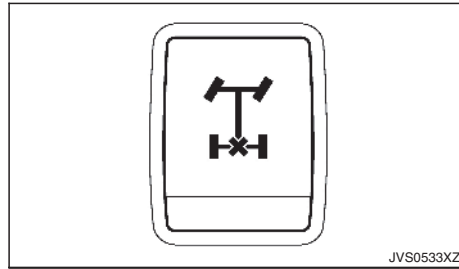

The rear differential lock is designed to transmit engine power to the left and right rear wheels equally.

If your vehicle is stuck in sand, snow, mud, etc. or one wheel is off the ground and the differential lock is not on, engine power is transmitted to the wheel with least resistance causing it to spin, leaving insufficient traction on the other wheel. The rear differential lock allows the left and right wheels to rotate as a unit, enabling your vehicle to free itself.

To lock the rear differential gear:

- 1) Stop the vehicle completely.
- 2) Turn the 4WD mode switch to the 4LO position. For operation of the 4WD mode switch, see "Four-Wheel Drive (4WD) (where fitted)" earlier in this section.
- 3) Push the differential lock mode switch to the ON position. The differential lock indicator light  will blink in the meter and then remains on while the differential gear is completely locked.

After using the rear differential lock, or when resuming normal driving, push the differential lock mode switch to the OFF position. The differential lock indicator light will turn off after the differential lock is released.

NOTE

The rear differential lock-up device operates only when the engine is running.

In 4H mode, the rear differential lock-up device does not operate when the differential lock mode switch is turned to the "ON" position. (The differential lock indicator light will flash.)



WARNING

Use the rear differential lock only in an emergency when it is not possible to free a stuck vehicle even using the 4LO position.

When the differential lock is in operation, turning the vehicle becomes hard and, especially at high speeds, is dangerous.

While differential lock is on, the Anti-lock Braking System (ABS) warning light and the Electronic Stability Programme (ESP) off indicator light illuminate. This indicates that anti-lock function may not fully operate.

Do not operate the differential lock when the vehicle is turning or when one side wheel is rotating. Otherwise the power train system parts could be damaged.

ELECTRONIC STABILITY PROGRAMME (ESP) SYSTEM (where fitted)

Avoid quick starts while the differential lock is in operation. Otherwise the power train system parts could be damaged.

Observe the above precautions. Otherwise, loss of normal steering control may result.





WARNING

The Electronic Stability Programme (ESP) system is designed to help the driver maintain stability but does not prevent accidents due to abrupt steering operation at high speeds or by careless or dangerous driving techniques. Reduce vehicle speed and be especially careful when driving and cornering on slippery surfaces and always drive carefully.

Do not modify the vehicle's suspension. If suspension parts such as shock absorbers, struts, springs, stabiliser bars, bushings and wheels are not recommended by RENAULT for your vehicle or are extremely deteriorated, the ESP system may not operate properly. This could adversely affect vehicle handling performance, and the ESP warning light  may illuminate.

If brake related parts such as brake pads, rotors and callipers are not RENAULT-recommended or are extremely deteriorated, the ESP system may not operate properly and the ESP warning light  may illuminate.

If engine control related parts are not RENAULT recommended or are extremely deteriorated, the ESP warning light  may illuminate.

When driving on extremely inclined surfaces such as higher banked corners, the ESP system may not operate properly and the ESP warning light  may illuminate. Do not drive on these types of roads.

When driving on an unstable surface such as a turntable, ferry, elevator or ramp, the ESP warning light  may illuminate. This is not a malfunction. Restart the engine after driving onto a stable surface.

If wheels or tyres other than the RENAULT recommended ones are used, the ESP system may not operate properly and the ESP warning light  may illuminate.

The ESP system is not a substitute for winter tyres or tyre chains on a snow covered road.

The Electronic Stability Programme (ESP) system uses various sensors to monitor driver inputs and vehicle motion. Under certain driving conditions, the ESP system performs the following functions:

Controls brake pressure to reduce wheel slip on one slipping drive wheel so power is transferred to a non slipping drive wheel on the same axle.

Controls brake pressure and engine output to reduce drive wheel slip based on vehicle speed (traction control function).

Controls brake pressure at individual wheels and engine output to help the driver maintain control of the vehicle in the following conditions:

- understeer (vehicle tends to not follow the steered path despite increased steering input)
- oversteer (vehicle tends to spin due to certain road or driving conditions).

The ESP system can help the driver to maintain control of the vehicle, but it cannot prevent loss of vehicle control in all driving situations.



When the ESP system operates, the ESP warning light  in the instrument panel flashes so note the following:

The road may be slippery or the system may determine some action is required to help the vehicle on the steered path.

You may feel a pulsation in the brake pedal and hear a noise or vibration from under the bonnet. This is normal and indicates that the ESP system is working properly.

Adjust your speed and driving to the road conditions.

If a malfunction occurs in the system, the ESP warning light  illuminates in the instrument panel. The ESP system automatically turns off.

The ESP OFF switch is used to turn off the ESP system. The ESP off indicator light  illuminates to indicate the ESP system is off. When the ESP OFF switch is used to turn off the system, the ESP system still operates to prevent one drive wheel from slipping by transferring power to a non slipping drive wheel. The ESP warning light  flashes if this occurs. All other ESP functions are off and the ESP warning light  will not flash. The ESP system is automatically reset to on when the ignition switch is placed in the **OFF** position then back to the **ON** position.

When the <4LO> position is selected with the Four-Wheel Drive (4WD) mode switch, the ESP system is disabled and the ESP OFF indicator light illuminates.

See "Warning lights, indicator lights and audible reminders" in the "2. Instruments and controls" section and "Four-Wheel Drive (4WD) (where fitted)" earlier in this section.

The computer has a built-in diagnostic feature that tests the system each time you start the engine and move the vehicle forward or in reverse at a slow speed. When the self-test occurs, you may hear a "clunk" noise and/or feel a pulsation in the brake pedal. This is normal and is not an indication of a malfunction.

ELECTRONIC STABILITY PROGRAMME (ESP) OFF SWITCH

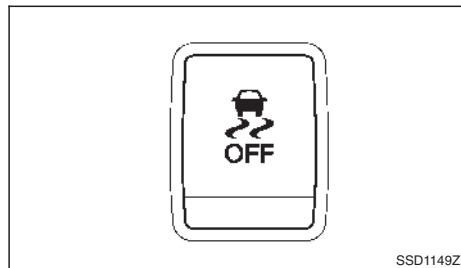

The vehicle should be driven with the Electronic Stability Programme (ESP) system ON for most driving conditions.

When the vehicle is stuck in mud or snow, the ESP system reduces the engine output to reduce wheel spin. The engine speed will be reduced even if the accelerator is depressed to the floor. If maximum engine power is needed to free a stuck vehicle, turn the ESP system off.

To turn off the Electronic Stability Programme (ESP) system, push the ESP OFF switch. The ESP off indicator light  will illuminate.

Push the ESP OFF switch again or restart the engine to turn on the Electronic Stability Programme (ESP) system.

ACTIVE EMERGENCY BRAKING SYSTEM (where fitted)

The Active Emergency Braking system can assist the driver when there is a risk of a forward collision with the vehicle ahead in the travelling lane.

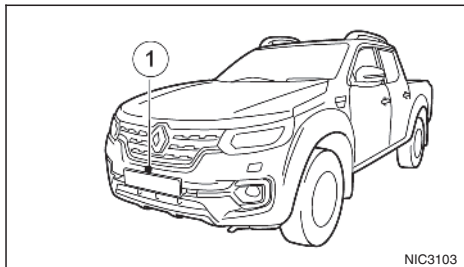

The Active Emergency Braking system uses a radar sensor ① located at the front of the vehicle to measure the distance to the vehicle ahead in the travelling lane.



WARNING

The Active Emergency Braking system is a supplemental aid to the driver. It is not a replacement for the driver's attention to traffic conditions or responsibility to drive safely. It cannot prevent accidents due to carelessness or dangerous driving techniques.

The Active Emergency Braking system does not function in all driving, traffic, weather and road conditions.

SYSTEM OPERATION



The Active Emergency Braking system will function when your vehicle is driven at speeds above approximately 5 km/h (3 MPH).

If a risk of a forward collision is detected, the Active Emergency Braking system will provide the first warning to the driver by flashing the forward collision warning light (orange) and providing an audible warning.

If the driver applies the brakes quickly and forcefully after the warning, and the Active Emergency Braking system detects that there is still the possibility of a forward collision, the system will automatically increase the braking force.

If the driver does not take action, the Active Emergency Braking system issues the second visual warning (red) and audible warning. If the driver releases the accelerator pedal, then the system applies partial braking

If the risk of a collision becomes imminent, the Active Emergency Braking system applies harder braking automatically.

Warning	Visual	Audible
First		Chime
Second		High pitched chime

Overview of warnings

NOTE

The vehicle's brake lights come on when braking is performed by the Active Emergency Braking system.

Depending on vehicle speed and distance to the vehicle ahead, as well as driving and roadway conditions, the system may help the driver avoid a forward collision or may help mitigate the consequences if a collision should one be unavoidable.

If the driver is handling the steering wheel, accelerating or braking, the Active Emergency Braking system will function later or will not function.

The automatic braking will cease under the following conditions:

When the steering wheel is turned as far as necessary to avoid a collision.

When the accelerator pedal is depressed.

When there is no longer a vehicle detected ahead.

If the Active Emergency Braking system has stopped the vehicle, the vehicle will remain at a standstill for approximately 2 seconds before the brakes are released.



WARNING

The radar sensor does not detect the following objects:

- Pedestrians, animals or obstacles in the roadway
- Oncoming vehicles
- Crossing vehicles

The radar sensor has some performance limitations. If a stationary vehicle is in the vehicle's path, the Active Emergency Braking system will not function when the vehicle is driven at speeds over approximately 70 km/h (44 MPH).

The radar sensor may not detect a vehicle ahead in the following conditions:

- Dirt, ice, snow or other material covering the radar sensor.
- Interference by other radar sources.
- Snow or road spray from travelling vehicles.
- If the vehicle ahead is narrow (e.g. motorcycle).
- When driving on a steep downhill slope or roads with sharp curves.
- When towing a trailer.

In some road or traffic conditions, the Active Emergency Braking system may unexpectedly apply partial braking. When acceleration is necessary, continue to depress the accelerator pedal to override the system.

Braking distances increase on slippery surfaces.

Excessive noise will interfere with the warning chime sound, and the chime may not be heard.

The system is designed to automatically check the sensor's functionality, within certain limitations. The system may not detect some forms of obstruction of the sensor area of the front bumper such as ice, snow, stickers, for example. In these cases, the system may not be able to warn the driver properly. Be sure that you check, clean and clear the sensor area of the front bumper regularly

Turning the Active Emergency Braking system ON/OFF

Perform the following steps to turn the Active Emergency Braking system ON or OFF.

Models with colour display:

1. Using the ▲ or ▼ switches and the <ENTER> button on the left side of the steering wheel, select the Settings menu in the vehicle information display. (See "Vehicle information display" in the "2. Instruments and controls" section)
2. Using the ▲ or ▼ switches and the <ENTER> button, navigate to the [Driver Assistance] menu, followed by the [Driving Aids] menu.
3. In the [Driving Aids] menu, highlight the [Emergency Brake] item and use the <ENTER> button to toggle between ON (enabled) or OFF (disabled).

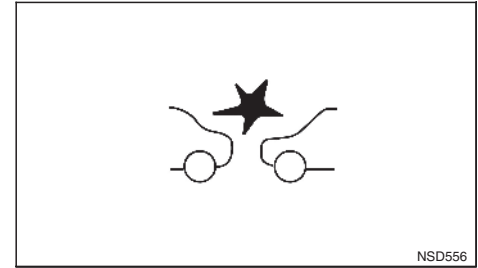

When the Active Emergency Braking system is turned off, the Active Emergency Braking system warning light (orange) will illuminate.

NOTE

Disabling the ESP system with the Electronic Stability Programme (ESP) OFF switch causes the Active Emergency Braking system to become unavailable regardless of settings selected in the Vehicle Information Display.

HILL DESCENT CONTROL SYSTEM (where fitted)

System temporarily unavailable

Condition A:

When the radar picks up interference from another radar source, making it impossible to detect a vehicle ahead, the Active Emergency Braking system is automatically turned off. The Active Emergency Braking system warning light (orange) will illuminate.

Action to take:

When the above conditions no longer exist, the Active Emergency Braking system will resume automatically.

Condition B:

When the sensor area of the front bumper is covered with dirt or obstructed, making it impossible to detect a vehicle ahead, the Active Emergency Braking system is automatically turned off. The Active Emergency Braking system warning light (orange) will illuminate and the "front radar obstruction" warning message will appear in the vehicle information display.

Action to take:

If the warning light (orange) comes on, park the vehicle in a safe location and turn the engine off. Check to see if the sensor area of the front bumper is blocked. If the sensor area of the front bumper is blocked, remove the blocking material. Restart the engine. If the warning light continues to illuminate, have the Active Emergency Braking system checked by an approved dealer or qualified workshop.

System malfunction

If the Active Emergency Braking system malfunctions, it will be turned off automatically, a chime will sound, the Active Emergency Braking system warning light (orange) will illuminate and the warning message [Malfunction] will appear in the vehicle information display.

Action to take:

If the warning light (orange) comes on, park the vehicle in a safe location, turn the engine off and restart the engine. If the warning light continues to illuminate, have the Active Emergency Braking system checked by an approved dealer or qualified workshop.



WARNING

Never rely solely on the hill descent control system to control vehicle speed when driving on steep downhill grades. Always drive carefully when using the hill descent control system and decelerate the vehicle speed by depressing the brake pedal if necessary. Be especially careful when driving on frozen, muddy or extremely steep downhill roads. Failure to control vehicle speed may result in a loss of control of the vehicle and possible serious injury or death.

The hill descent control system may not control the vehicle speed on a hill under all load or road conditions. Always be prepared to depress the brake pedal to control vehicle speed. Failure to do so may result in a collision or serious personal injury.

When the hill descent control system is activated, it automatically applies smooth brakes to control speed on a steep and slippery descent or off the road without brake or accelerator operation. The hill descent control system helps maintain vehicle speed when driving under 25 km/h (16 MPH) on a steep descent that engine braking alone in the <4H> or <4LO> mode cannot control the speed.

HILL START ASSIST SYSTEM (where fitted)

NOTE

When the hill descent control system operates continuously for a long time, the temperature of the Electronic Stability Programme (ESP) system actuator may increase and the hill descent control system may be temporarily disabled. The hill descent control system on indicator light will turn off. The hill descent control system will resume operating automatically and the indicator light will illuminate again when the temperature of the ESP system actuator is reduced. If the indicator light does not illuminate, turn off the system.

HILL DESCENT CONTROL SWITCH



When additional braking is required on steep downhill roads, activate the hill descent control system by pushing the hill descent control switch on.

When the hill descent control system is activated, the hill descent control system on indicator light will illuminate. (See "Warning lights, indicator lights and audible reminders" in the "2. Instruments and

controls" section.) Also, the stop/tail lights illuminate while the hill descent control system is applying the brakes to control the vehicle speed.

To activate the hill descent control system, satisfy all of the following conditions:

Shift the transmission to the forward (only 1st gear for MT model) or reverse gear.

Shift the 4WD mode switch to the <4H> or <4LO> position and drive the vehicle at a speed under 25 km/h (16 MPH).

See "Warning lights, indicator lights and audible reminders" in the "2. Instruments and controls" section.

Push the hill descent control switch to the "ON" position.

If the accelerator or brake pedal is depressed while the hill descent control system is on, the system will stop operating temporarily. As soon as the accelerator or brake pedal is released, the hill descent control system begins to function again if the hill descent control operating conditions are fulfilled.

The hill descent control system on indicator light blinks if the hill descent control switch is on and all conditions for system activation are not met, or if the system becomes disengaged for any reason.

To turn off the hill descent control system, push the hill descent control switch to the "OFF" position.



WARNING

Never rely solely on the hill start assist system to prevent the vehicle from moving backward on a hill. Always drive carefully and attentively. Depress the brake pedal when the vehicle is stopped on a steep hill. Be especially careful when stopped on a hill on frozen or muddy roads. Failure to prevent the vehicle from rolling backwards may result in a loss of control of the vehicle and possible serious injury or death.

The hill start assist system is not designed to hold the vehicle at a standstill on a hill. Depress the brake pedal when the vehicle is stopped on a steep hill. Failure to do so may cause the vehicle to roll backwards and may result in a collision or serious personal injury.

The hill start assist system may not prevent the vehicle from rolling backwards on a hill under all load or road conditions. Always be prepared to depress the brake pedal to prevent the vehicle from rolling backwards. Failure to do so may result in a collision or serious personal injury.

The hill start assist system automatically keeps the brakes applied to help prevent the vehicle from rolling backwards in the time it takes the driver to release the brake pedal and apply the accelerator when the vehicle is stopped on a hill.

CRUISE CONTROL (where fitted)

The hill start assist system will operate automatically under the following conditions:

The transmission is shifted to a forward or reverse gear.

The vehicle is stopped completely on a hill by applying the brake.

The maximum holding time is 2 seconds. After 2 seconds the vehicle will begin to roll back and the hill start assist system will stop operating completely.

The hill start assist system will not operate when the transmission is shifted to the N (Neutral) or P (Park) position or on a flat and level road.

When the Electronic Stability Programme (ESP) warning light illuminates in the meter, the hill start assist system will not operate. (See "Electronic Stability Programme (ESP) system (where fitted)" earlier in this section.)

The cruise control system allows driving at constant speeds without keeping your foot on the accelerator pedal.



WARNING

The cruise control system ONLY maintains a constant vehicle speed, it does not replace the driver.

Always observe the posted speed limits and do not set the speed over them.

Do not use the cruise control when driving under the following conditions. Doing so could cause a loss of vehicle control and result in an accident.

- **When it is not possible to keep the vehicle at a constant speed**
- **When driving in heavy traffic**
- **When driving in traffic that varies speed**
- **When driving in windy areas**
- **When driving on winding or hilly roads**
- **When driving on slippery (rain, snow, ice, etc.) roads**

CAUTION

On manual Transmission (MT) model, do not shift to the N (Neutral) position without depressing the clutch pedal when the cruise control is operated. Should this occur, depress the clutch pedal and turn the cruise control MAIN switch off immediately. Failure to do so may cause engine damage.

When the cruise control system is on the speed limiter cannot be operated.

The cruise control system operation switches are located on the steering wheel (right side).

The cruise control system operating condition is shown in the vehicle information display.

PRECAUTIONS ON CRUISE CONTROL

If the cruise control system malfunctions, it will cancel automatically. The **CRUISE** or **SET** (where fitted) indicator in the vehicle information display will then blink to warn the driver.

If the **CRUISE** or **SET** indicator blinks, turn the cruise control MAIN switch off and have the system checked by an approved dealer or qualified workshop.

The **CRUISE** or **SET** indicator may blink when the cruise control MAIN switch is turned ON while pushing the <RES/+>, <SET/->, or <CANCEL> switch. To properly set the cruise control system, perform the following procedures.

CRUISE CONTROL OPERATIONS

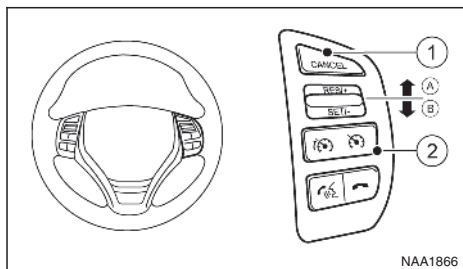

Models with speed limiter (where fitted)

- ① <CANCEL> switch
- A <RES/+> (Resume) switch
- B <SET/—> switch
- ② Cruise control main ON/OFF switch
- ③ Speed limiter main ON/OFF switch
(For details, see "Speed limiter (where fitted)"
later in this section) (where fitted)

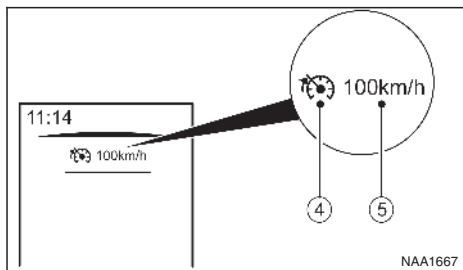

- ④ Cruise control symbol
- ⑤ Set speed value

The cruise control allows driving at speeds above 40 km/h (25 MPH) without keeping your foot on the accelerator pedal.

The cruise control will automatically be cancelled if the vehicle speed slows to less than approximately 33 km/h (21 MPH).

Moving the shift lever to the N (Neutral) position (Automatic Transmission models) or depressing the clutch pedal (Manual Transmission models) will cancel the cruise control.

Turning the cruise control system on

Push the cruise control main switch ②. The cruise control symbol ④ appears together with the last set speed value (or — —) ⑤ in the top of the vehicle information display.

Setting a cruising speed

1. Accelerate to the desired speed.
2. Push the <SET/—> switch B and release it.
3. The cruise control symbol ④ appears together with the set speed value (desired cruising speed) ⑤ in the top of the vehicle information display.
4. Take your foot off the accelerator pedal.

The vehicle will maintain the set speed.

If the vehicle speed is less than the minimum set speed, it will not be possible to set the cruise control system.

Resuming at preset speed:

Push and release the <RES/+> switch A.

The vehicle will resume the last set cruising speed when the vehicle speed is over 40 km/h (25 MPH).

Changing a cruising speed

Use any one of the following methods to change the cruising speed.

Resetting to lower speed:

Use any one of the following methods to reset to a lower speed.

Slow the vehicle as normal using the footbrake pedal.

When the vehicle reaches the desired cruising speed, push and release the <SET/—> switch B downwards.

The new set speed value will be displayed in the top of the vehicle information display.

Push and hold the <SET/—> switch B to decrease the set speed in steps of 5 km/h (3 MPH). When the vehicle information display reaches the desired speed, release the <SET/—> switch for the setting to take effect.

Quickly push and release the <SET/—> switch B. This will reduce the vehicle speed by about 1 km/h (1 MPH).

The new set speed value will be displayed in the top of the vehicle information display.

Resetting to higher speed:

Use any one of the following methods to reset to a higher speed.

Depress the accelerator pedal. When the vehicle reaches the desired speed, push and release the <SET/→> switch .

Push and hold the <RES/+> switch  to increase the set speed in steps of 5 km/h (3 MPH).

When the vehicle information display reaches the desired speed, release the <RES/+> switch for the setting to take effect.

Quickly push and release the <RES/+> switch . This will increase the vehicle speed by about 1 km/h (1 MPH).

The new set speed value will be displayed in the top of the vehicle information display.

Resuming at preset speed:

Push and release the <RES/+> switch .

The vehicle will resume the last set cruising speed when the vehicle speed is over 40 km/h (25 MPH).

Passing another vehicle

Depress the accelerator pedal to accelerate. After releasing the accelerator pedal, the vehicle will return to the previously set speed.

The set speed value  will flash until the vehicle returns to the previously set speed.

Cancelling cruising speed

Use any one of the following methods to cancel the set speed.

Push the <CANCEL> switch .

Tap the footbrake pedal.

Push the cruise control MAIN switch . The indicator  will turn off.

The speed limiter allows you to set the desired vehicle speed limit. While the speed limiter is activated, you can perform normal braking and acceleration, but the vehicle will not exceed the set speed.

When the vehicle reaches the set speed limit or if the set speed limit is lower than the actual vehicle speed, the accelerator pedal will not work until the vehicle speed drops below the set speed limit.

When the actual vehicle speed exceeds the set speed, an audible warning will be heard a short time after the set speed is exceeded and driver intervention is not detected.

When the speed limiter is on the cruise control system cannot be operated.



WARNING

The speed limiter will not automatically brake the vehicle to the set speed limit.

Always observe posted speed limits. Do not set the speed above them.

Always confirm the setting status of the speed limiter in the vehicle information display.

When the speed limiter is set, avoid hard acceleration to reach the set limit to ensure that the system can limit the speed of the vehicle correctly.

When additional floor mats are used, be sure that they are correctly secured and that they cannot interfere with the accelerator pedal. Mats not adapted to the vehicle may prevent proper operation of the speed limiter.

The speed limiter operation switches are located on the steering wheel (right hand side).

The speed limiter operating condition is shown on the top of vehicle information display. For details, see "Vehicle information display" in the "2. Instruments and controls" section.

SPEED LIMITER OPERATIONS

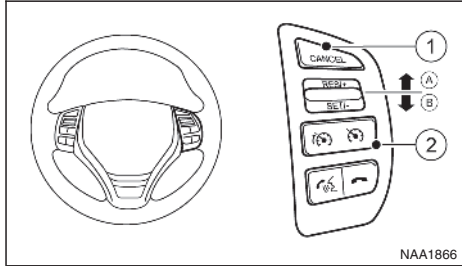

- ① <CANCEL> switch
- Ⓐ <RES/+> (Resume) switch
- Ⓑ <SET/-> (Set) switch
- ② Speed limiter main "ON/OFF" switch
- ③ Cruise control main "ON/OFF" switch. (For details, see "Cruise control (where fitted)" earlier in this section)

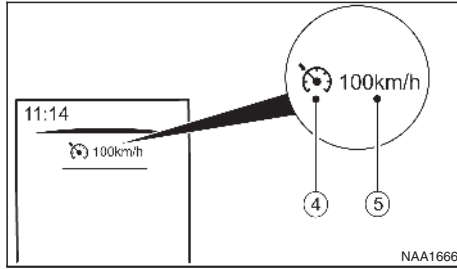

- ④ Speed limiter symbol
- ⑤ Set speed value

Turning the speed limiter on

The speed limiter can be switched on after engine start or when driving.

Push the speed limiter main "ON/OFF" switch ③.

Setting speed limit

Push the <SET/-> switch Ⓑ (downwards).

Depending on the model:

The speed limit will be set at the current speed.

When driving less than 30 km/h (20 MPH), the speed limiter will be set to the minimum possible set speed of 30 km/h (20 MPH).

Set the speed limiter while driving over 30 km/h (20 MPH).

When the speed limit is set, the speed limiter symbol ④ and the set speed value ⑤ will illuminate in the vehicle information display. The limiter symbol will turn green.

Changing a speed limit

Use either of the following operations to change an active speed limit:

Push and release the <RES/+> (Resume) switch Ⓐ upwards or <SET/-> switch Ⓑ downwards. Each time you do this, the set speed will increase or decrease by 1 km/h (1 MPH).

Push and hold the <RES/+> (Resume) switch Ⓐ upwards or <SET/-> switch Ⓑ downwards. The set speed will increase or decrease to the next multiple of 5 km/h (5 MPH) and then in steps of 5 km/h (5 MPH).

The new set speed limit value ⑤ will be displayed in the vehicle information display.

When the actual vehicle speed exceeds the set speed, an audible warning will be heard a short time after the set speed is exceeded and driver intervention is not detected.

Cancelling a speed limit

To cancel a set speed limit, push the <CANCEL> switch ①. The speed limiter symbol ④ and the set speed value ⑤ in the vehicle information display will be turned off.

It is also possible to override the speed limiter by fully depressing the accelerator pedal beyond the resistance point.



WARNING

The vehicle may accelerate when the speed limiter cancels.

When additional floor mats are used, be sure that they are correctly secured and that they cannot interfere with the accelerator pedal. Mats not adapted to the vehicle may prevent proper operation of the speed limiter.

Fully depress the accelerator pedal beyond the resistance point. The speed limiter will be suspended to allow driving above the set speed. The set speed value ⑤ will flash and an audible warning will sound. The speed limiter will automatically resume when the vehicle speed drops below the set speed limit.

Resuming a previous set speed

If a set speed limit has been cancelled, the set speed will be stored in the speed limiter memory.

This speed limit can be reactivated by pressing the <RES/+> (Resume) switch ① upwards.

If the current vehicle speed is higher than the previous set speed, the accelerator pedal will not work and the set speed value ⑤ will flash until the vehicle speed drops below the set speed limit.

When the actual vehicle speed exceeds the set speed, an audible warning will be heard a short time after the set speed is exceeded and driver intervention is not detected.

Turning the speed limiter off

The speed limiter system will be turned off when one of the following operations is performed:

Push the speed limiter main "ON/OFF" switch ③. The speed limiter symbol ④ and the set speed value ⑤ in the vehicle information display will be turned off.

Push the cruise control main "ON/OFF" switch ②. The speed limiter information in the vehicle information will be replaced with the cruise control information. For details see "Cruise control (where fitted)" earlier in this section.

When the vehicle is stopped and the ignition is turned to the off position.

Turning off the speed limiter will erase the set speed limit memory.

Speed limiter malfunction

If the speed limiter malfunctions, the speed limiter symbol ④ in the vehicle information display will flash.

Turn the speed limiter off by pushing the speed limiter main "ON/OFF" switch ③ and have the system checked by an approved dealer or qualified workshop.

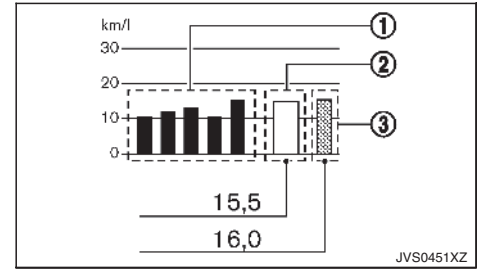

When the ignition switch is in the **OFF** position, ECO management display appears.

- ① Previous 5 times (History)
- ② Current fuel economy
- ③ Best fuel economy

The result of ECO evaluation is displayed 30 seconds after the ignition switch is placed in the on position and the vehicle is driven at least 500 meters (1/3 miles).

- ①: The average fuel economy for the previous 5 times will be displayed.
- ②: The average fuel economy since the last reset will be displayed.
- ③: The best fuel economy of the past history will be displayed.

The ECO drive report can be set to be **ON** or **OFF**. See "[ECO Drive Report] (where fitted)" in the "2. Instruments and controls" section.

PARKING



WARNING

Do not stop or park the vehicle over flammable materials such as dry grass, waste paper or rags. They may ignite and cause a fire.

Safe parking procedures require that both the parking brake be applied and the shift lever be placed into the P (Park) position for Automatic Transmission (AT) model or in an appropriate gear for Manual Transmission (MT) model. Failure to do so could cause the vehicle to move unexpectedly or roll away and result in an accident.

When parking the vehicle, make sure the shift lever is moved to the P (Park) position. The shift lever cannot be moved out of the P (Park) position without depressing the footbrake pedal (AT model).

Never leave the engine running while the vehicle is unattended.

To help avoid risk of injury or death through unintended operation of the vehicle and/or its systems, do not leave children, people who require the assistance of others or pets unattended in your vehicle. Additionally, the temperature inside a closed vehicle on a warm day can quickly become high enough to cause a significant risk of injury or death to people and pets.

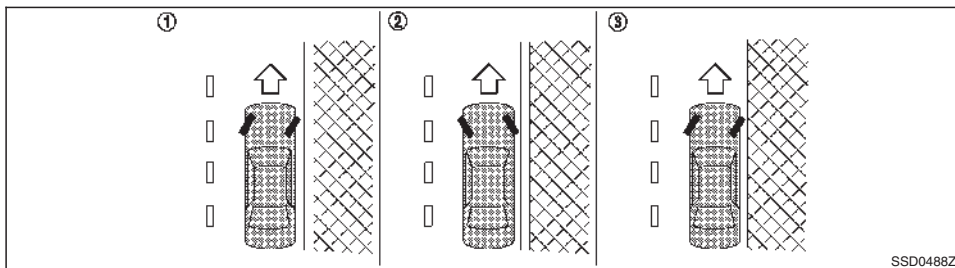

Left-Hand Drive (LHD) model

SSD0488Z

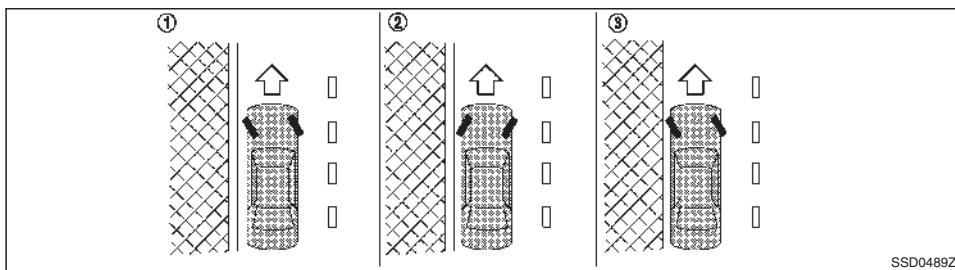

Right-Hand Drive (RHD) model

SSD0489Z

1. Firmly apply the parking brake.

2. Automatic Transmission (AT) model: Move the shift lever to the P (Park) position.

Manual Transmission (MT) model: Move the shift lever to the R (Reverse) position. When parking on an uphill grade, move the shift lever to the 1 (1st) position.

3. To help prevent the vehicle from moving into traffic when parked on an incline, it is a good practice to turn the wheels as illustrated.

PARKING SENSOR (SONAR) SYSTEM (where fitted)

HEADED DOWNHILL WITH KERB ①

Turn the wheels into the kerb and move the vehicle forward until the kerb side wheel gently touches the kerb. Then apply the parking brake.

HEADED UPHILL WITH KERB ②

Turn the wheels away from the kerb and allow the vehicle to move back until the kerb side wheel gently touches the kerb. Then apply the parking brake.

HEADED UPHILL OR DOWNHILL, WITHOUT KERB ③

Turn the wheels toward the side of the road so the vehicle will move away from the centre of the road if the vehicle moves. Then apply the parking brake.

4. Model with Remote Control Key:

Place the ignition switch in the "OFF" position.

Model without Remote Control Key:

Place the ignition switch in the "LOCK" position and remove the key.

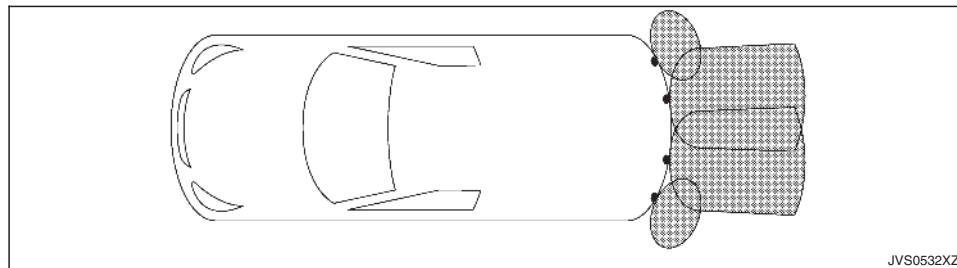

JVS0532XZ

The parking sensor (sonar) system sounds a tone to inform the driver of obstacles near the bumper.

When the "Display" key is ON, the sensor view will automatically appear in the vehicle information display.



WARNING

The parking sensor (sonar) system is a convenience but it is not a substitute for proper parking. The driver is always responsible for safety during parking and other manoeuvres. Always look around and check that it is safe to do so before parking.

Read and understand the limitations of the parking sensor (sonar) system as contained in this section. The colours of the corner sensor indicator and the distance guide lines in the rear view indicate different distances to the object. Inclement weather or ultrasonic sources such as an automatic car wash, a truck's compressed-air brakes, or a pneu-

matic drill may affect the function of the system; this may include reduced performance or a false activation.

This function is designed as an aid to the driver in detecting large stationary objects to help avoid damaging the vehicle. The system is not designed to prevent contact with small or moving objects. Always move slowly.

The system will not detect small objects below the bumper, and may not detect objects close to the bumper or on the ground.

The system may not detect the following objects.

- Fluffy objects such as snow, cloth, cotton, glass-wool, etc.
- Thin objects such as rope, wire, chain, etc.
- Wedge-shaped objects

If your vehicle sustains damage to the bumper fascia, leaving it misaligned or bent, the sensing zone may be altered causing inaccurate measurement of obstacles or false alarms.

CAUTION

Keep the interior of the vehicle as quiet as possible to hear the tone clearly.

Keep the sensors (located on the bumper fascia) free from snow, ice, and large accumulations of dirt. Do not clean the sensors with sharp objects. If the sensors are covered, the accuracy of the sensor function will be diminished.

The system informs with visual and audible signals of rear obstacles when the shift lever is in the R (Reverse) position.

The system is deactivated at speeds above 10 km/h (6 MPH). It is reactivated at lower speeds.

The intermittent tone will stop after 3 seconds when an obstacle is detected only by a corner sensor and the distance does not change. The tone will stop when the obstacle moves away from the vehicle.

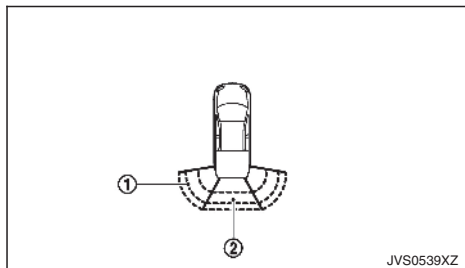

When the corner of the vehicle moves closer to an object, the corner sensor indicators ① appears.

When the centre of the vehicle moves close to an object, the centre sensor indicator ② appears.

When the object is detected, the indicator (green) appears and the tone sounds intermittently. When the vehicle moves closer to the object, the colour of the indicator turns yellow. When the vehicle is very close to the object, the indicator turns red, and the tone sounds continuously.

PARKING SENSOR (SONAR) SYSTEM OFF SWITCH

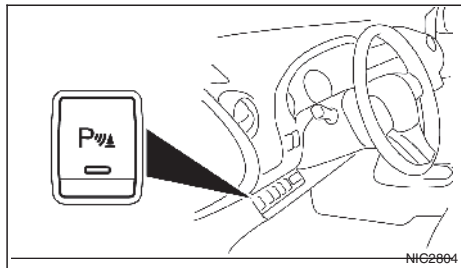

The parking sensor (sonar) system OFF switch on the instrument panel allows the driver to turn the parking sensor (sonar) system ON or OFF. To turn the parking sensor (sonar) system ON or OFF, the ignition switch must be in the **ON** position.

The indicator light on the switch will illuminate when the system is turned ON.

If the indicator light flashes when the parking sensor (sonar) system is not turned off, it may indicate a malfunction in the parking sensor (sonar) system.

The parking sensor (sonar) system will be turned ON automatically under the following conditions:

When the ignition switch is switched from the **OFF** position to the **ON** position.

When the shift lever is shifted into the R (Reverse) position.

When the vehicle speed reaches at least 10 km/h (6 MPH) and decreases.

The automatic system enabling function can be turned ON or OFF with the [Sensor] key in the [Parking Aids] menu. See "Vehicle information display" in the "2. Instruments and controls" section.

PARKING SENSOR (SONAR) SYSTEM SETTINGS

The following settings for the parking sensor (sonar) system can be changed by using the switches on the steering-wheel-mounted controls. For details, see "Vehicle information display" in the "2. Instruments and controls" section.

[Sensor]

Activate or deactivate the Parking sensor system.

ON (default) - OFF

[Volume]

Adjust the volume of the tone.

[High] - [Med.] (default) - [Low]

[Range]

Adjust the detection range of the sensor.

[Far] - [Mid.] (default) - [Near]

TRAILER TOWING

Your new vehicle was designed to be used primarily to carry passengers and luggage.

Towing a trailer will place additional loads on your vehicle's engine, drive train, steering, braking and other systems. The towing of a trailer will exaggerate other conditions such as sway caused by crosswinds, rough road surfaces or passing trucks.

Your driving style and speed must be adjusted according to the circumstances. Before towing a trailer, see an approved dealer or qualified workshop for an explanation about the proper use of towing equipment.

OPERATING PRECAUTIONS

Avoid towing a trailer during the running-in period.

Before driving, make sure that the lighting system of the trailer works properly.

Observe the legal maximum speeds for trailer operation.

Avoid abrupt starts, accelerations and stops.

Avoid sharp turns and lane changes.

Always drive your vehicle at a moderate speed.

Follow the trailer manufacturer's instructions.

Choose proper coupling devices (trailer hitch, safety chain, roof carrier, etc.) for your vehicle and trailer. These devices are available from an approved dealer or qualified workshop where you can also obtain more detailed information about trailer towing.

Never allow the total trailer load (trailer weight plus its cargo weight) to exceed the maximum set for the vehicle and the coupling device. See an approved dealer or qualified workshop for more information.

The trailer must be loaded so that heavy goods are placed over the axle. The maximum allowable vertical load on the trailer hitch must not be exceeded.

Have your vehicle serviced more often than at the intervals specified in a separate maintenance booklet.

Trailer towing requires more fuel than under normal circumstances because of a considerable increase in traction power and resistance.

While towing a trailer, check the engine coolant temperature indicator to prevent the vehicle from overheating.

TYRE PRESSURE

When towing a trailer, inflate the vehicle tyres to the maximum recommended COLD tyre pressure (for full loading) indicated on the tyre placard.

Do not tow a trailer when the vehicle is installed with a temporary spare tyre or a compact spare tyre.

SAFETY CHAINS

Always use a suitable chain between the vehicle and trailer. The chain should be crossed and should be attached to the hitch, not to the vehicle bumper or axle. Be sure to leave enough slack in the chain to permit turning corners.

TRAILER BRAKES

Ensure that trailer brakes are installed as required by local regulations. Also check that all other trailer equipment conforms to local regulations.

Always block the wheels on both the vehicle and trailer when parking. Apply the hand brake on the trailer where fitted. Parking on a steep slope is not recommended.

If parking on a steep slope is unavoidable, place the shift lever in the P (Park) position (Automatic transmission model), or in an appropriate position (Manual transmission model), and turn the front wheels towards the kerb.

TRAILER DETECTION (where fitted)

When towing a trailer with a genuine RENAULT tow bar electrical kit and the turn signal switch is used, the electrical system of the vehicle will detect the additional electrical load of the trailer lighting. As a result, the direction indicator tone will be different.

VEHICLE SECURITY

When leaving your vehicle unoccupied:

Always take the key with you - even when leaving the vehicle in your own garage.

Close all windows completely and lock all doors.

Always park your vehicle where it can be seen. Park in a well lit area during the night.

If the security system is equipped, use it - even for a short period.

Never leave children or pets in the vehicle unattended.

Never leave valuables inside the vehicle. Always take valuables with you.

Never leave the vehicle documents in the vehicle.

Never leave articles on a roof rail. Remove them from the rack and keep and lock them inside the vehicle.

Never leave the spare key in the vehicle.

POWER STEERING SYSTEM



WARNING

If the engine is not running or is turned off while driving, the power assist for the steering will not work. The steering will be much harder to operate.

The power assisted steering is designed to use a hydraulic pump driven by the engine, to assist steering.

If the engine stops or the drive belt breaks, you will still have control of the vehicle. However, greater steering effort is needed, especially in sharp turns and at low speeds.

BRAKE SYSTEM

The brake system has two separate hydraulic circuits. If one circuit malfunctions, you will still have braking ability at two wheels.

BRAKE PRECAUTIONS

Vacuum assisted brakes

The brake booster aids braking by using engine vacuum. If the engine stops, you can stop the vehicle by depressing the footbrake pedal. However, greater foot pressure on the footbrake pedal will be required to stop the vehicle. The stopping distance will be longer.

If the engine is not running or is turned off while driving, the power assisted brakes will not function. Braking will be harder.



WARNING

Do not coast with the engine stopped.

Using brakes

Avoid resting your foot on the footbrake pedal while driving. This will overheat the brakes, wear out the brake linings/pads faster, and increase fuel consumption.

To help reduce brake wear and to prevent the brakes from overheating, reduce speed and downshift to a lower gear before going down a slope or long grade. Overheated brakes may reduce braking performance and could result in loss of vehicle control.

While driving on a slippery surface, be careful when braking, accelerating or downshifting. Abrupt braking or acceleration could cause the wheels to skid and result in an accident.

Wet brakes

When the vehicle is washed or driven through water, the brakes may get wet. As a result, your braking distance will be longer and the vehicle may pull to one side during braking.

To dry the brakes, drive the vehicle at a safe speed while lightly depressing the footbrake pedal to heat up the brakes. Do this until the brakes return to normal. Avoid driving the vehicle at high speeds until the brakes function correctly.

Parking brake running-in

Break in the parking brake shoes whenever the stopping effect of the parking brake is weakened or whenever the parking brake shoes and/or drums/rotors are replaced, in order to assure the best braking performance.

This procedure is described in the vehicle service manual and can be performed by an approved dealer or qualified workshop.

ANTI-LOCK BRAKING SYSTEM (ABS)



WARNING

The Anti-lock Braking System (ABS) is a sophisticated device, but it cannot prevent accidents resulting from careless or dangerous driving techniques. It can help maintain vehicle control during braking on slippery surfaces. Remember that stopping distances on slippery surfaces will be longer than on normal surfaces even with ABS. Stopping distances may also be longer on rough,

gravel or snow covered roads, or if you are using tyre chains. Always maintain a safe distance from the vehicle in front of you. Ultimately, the driver is responsible for safety.

Tyre type and condition may also affect braking effectiveness.

When replacing tyres, install the specified size of tyres on all four wheels.

When installing a spare tyre, make sure that it is the proper size and type as specified on the tyre placard. (See “Vehicle identification” in the “9. Technical information” section.)

For detailed information, see “Tyres and wheels” in the “9. Technical information” section.

The Anti-lock Braking System (ABS) controls the brakes so the wheels do not lock during hard braking or when braking on slippery surfaces. The system detects the rotation speed at each wheel and varies the brake fluid pressure to prevent each wheel from locking and sliding. By preventing each wheel from locking, the system helps the driver maintain steering control and helps to minimise swerving and spinning on slippery surfaces.

Using system

Depress the brake pedal and hold it down. Depress the brake pedal with firm steady pressure, but do not pump the brakes. The ABS will operate to prevent the wheels from locking up. Steer the vehicle to avoid obstacles.



WARNING

Do not pump the brake pedal. Doing so may result in increased stopping distances.

Self-test feature

The ABS includes electronic sensors, electric pumps, hydraulic solenoids and a computer. The computer has a built-in diagnostic feature that tests the system each time you start the engine and move the vehicle at a low speed in forward or reverse. When the self-test occurs, you may hear a “clunk” noise and/or feel a pulsation in the brake pedal. This is normal and does not indicate a malfunction. If the computer senses a malfunction, it switches the ABS off and illuminates the ABS warning light on the instrument panel. The brake system then operates normally, but without anti-lock assistance. If the ABS warning light illuminates during the self-test or while driving, have the vehicle checked by an approved dealer or qualified workshop.

Normal operation

The ABS operates at speeds above 5 to 10 km/h (3 to 6 MPH). The speed varies according to road conditions.

When the ABS senses that one or more wheels are close to locking up, the actuator rapidly applies and releases hydraulic pressure. This action is similar to pumping the brakes very quickly. You may feel a pulsation in the brake pedal and hear a noise from under the bonnet or feel a vibration from the actuator when it is operating. This is normal and indicates that the ABS is operating properly. However, the pulsation may indicate that road conditions are hazardous and extra care is required while driving.

COLD WEATHER DRIVING

When the differential lock (where fitted) is engaged, the ABS warning light illuminates. This indicates that the anti-lock function is not fully operating. (See "Rear differential locking system (where fitted)" earlier in this section for the rear differential lock function.)



WARNING

Whatever the condition, drive with caution. Accelerate and decelerate with great care. If accelerating or decelerating too fast, the drive wheels will lose even more traction.

Allow more stopping distance in cold weather driving. Braking should be started sooner than on dry pavement.

Keep at a greater distance from the vehicle in front of you on slippery roads.

Wet ice (0°C, 32°F and freezing rain), very cold snow and ice can be slick and very difficult to drive on. The vehicle will have a lot less traction or grip under these conditions. Try to avoid driving on wet ice until the road is salted or sanded.

Watch for slippery spots (glaring ice). These may appear on an otherwise clear road in shaded areas. If a patch of ice is seen ahead, brake before reaching it. Try not to brake while actually on the ice, and avoid any sudden steering manoeuvres.

Do not use cruise control on slippery roads.

Snow can trap dangerous exhaust gas under your vehicle. Keep snow clear of the exhaust pipe and from around your vehicle.

BATTERY

If the battery is not fully charged during extremely cold weather conditions, the battery fluid may freeze and damage the battery. To maintain maximum efficiency, the battery should be checked regularly. For details, see "Battery" in the "8. Maintenance and do-it-yourself" section of this manual.

ENGINE COOLANT

If the vehicle is to be left outside without anti-freeze, drain the cooling system, including the engine block. Refill before operating the vehicle. For details, see "Engine cooling system" in the "8. Maintenance and do-it-yourself" section of this manual.

TYRE EQUIPMENT

1. If you have snow tyres installed on the front/rear wheels of your vehicle, they should be of the same size, loading range, construction and type (bias, bias-belted or radial) as the rear/front tyres.
2. If the vehicle is to be operated in severe winter conditions, snow tyres should be installed on all four wheels.
3. For additional traction on icy roads, studded tyres may be used. However, some countries, provinces and states prohibit their use. Check local, state and provincial laws before installing studded tyres.

Skid and traction capabilities of studded snow tyres, on wet or dry surfaces, may be poorer than that of non-studded snow tyres.

4. Snow chains may be used if desired. Make sure they are the proper size for the tyres on your vehicle and are installed according to the chain manufacturer's instructions. Use chain tensioners when recommended by the tyre chain manufacturer to ensure a tight fit. Loose end links of the tyre chains must be secured or removed to prevent the possibility of whipping action damage to the wings or underbody. In addition, drive at a reduced speed, otherwise, your vehicle may be damaged and/or vehicle handling and performance may be adversely affected.

SPECIAL WINTER EQUIPMENT

It is recommended that the following items be carried in the vehicle during the winter:

A scraper and stiff-bristled brush to remove ice and snow from the windows.

A sturdy, flat board to be placed under the jack to give it firm support.

A shovel to dig the vehicle out of snowdrifts.

PARKING BRAKE

When parking in the area where the outside temperature is below 0°C (32°F), do not apply the parking brake to prevent it from freezing. For safe parking:

Place the shift lever in the P (Park) position (Automatic transmission model).

Place the shift lever in the 1 (1st) or R (Reverse) gear (Manual transmission model).

Securely block the wheels.

CORROSION PROTECTION

Chemicals used for road surface deicing are extremely corrosive and will accelerate corrosion and the deterioration of underbody components such as the exhaust system, fuel and brake lines, brake cables, floor pan and wings.

In the winter, the underbody must be cleaned periodically. For additional information, see "Cleaning exterior" in the "7. Appearance and care" section of this manual.

For additional protection against rust and corrosion, which may be required in some areas, consult an approved dealer or qualified workshop.

NOTE

6 In case of emergency

Hazard warning flasher switch	6-2	Jump starting	6-11
Flat tyre.....	6-2	Push starting.....	6-13
Stopping vehicle.....	6-2	If your vehicle overheats	6-13
Changing flat tyre (for models with spare tyre).....	6-2	Towing your vehicle	6-14
Repairing flat tyre (for models with emergency tyre puncture repair kit).....	6-7	Towing precautions.....	6-14
		Towing recommended by RENAULT	6-14

HAZARD WARNING FLASHER SWITCH

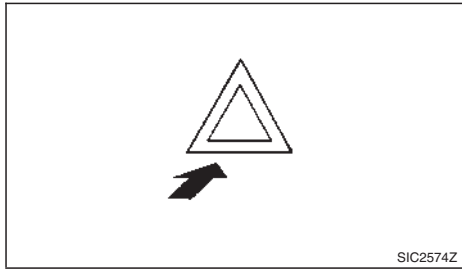

The hazard warning flasher switch operates regardless of the ignition switch position except when the battery is discharged.

The hazard warning flasher is used to warn other drivers when you have to stop or park under emergency conditions.

When the hazard warning flasher switch is pushed, all turn signal lights will flash. To turn off the hazard warning flasher, push the hazard warning flasher switch again.

FLAT TYRE

If you have a flat tyre, follow the instructions in this section.

STOPPING VEHICLE



WARNING

Be sure to apply the parking brake firmly.

Be sure to move the shift lever to the P (Park) position (automatic transmission model).

Be sure to move the shift lever to the R (Reverse) position (manual transmission model).

Never change tyres when the vehicle is on a slope, ice or slippery area. This is hazardous.

Never change tyres when the oncoming traffic is close to your vehicle. Call for professional road assistance.

1. Safely move the vehicle off the road and away from traffic.
2. Turn on the hazard warning flasher lights.
3. Park on a level surface.
4. Apply the parking brake.
5. **Automatic transmission model:**
Move the shift lever to the P (Park) position.
Manual transmission model:
Move the shift lever to the R (Reverse) position.
6. Turn off the engine.
7. Open the bonnet:
 - To warn other traffic.
 - To signal professional road assistance personnel that you need assistance.

8. Have all passengers get out of the vehicle and stand in a safe place, away from other traffic and clear of the vehicle.

CHANGING FLAT TYRE (for models with spare tyre)

Preparing tools

For King Cab model:

Models not equipped with jump seat:

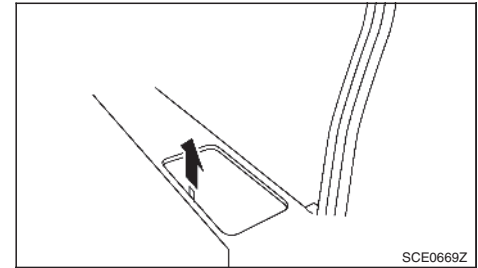

The tool storage compartment is located in the tier behind the front seat.

Open the lid of the tool storage compartment and remove the jack and necessary tools.

Models equipped with jump seat:

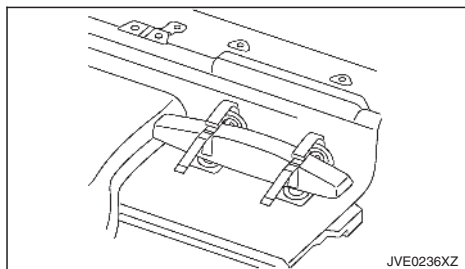

The jack and tools are stored under the jump seat.

For Double Cab model

The tool storage compartment is located under the rear seats.

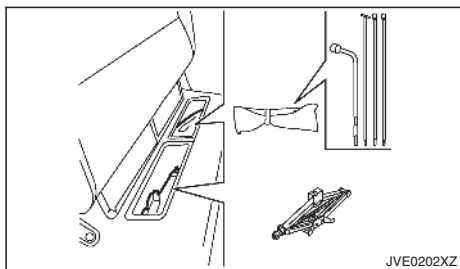

1. Fold the rear seat up ① and remove tool storage compartment lids ②.
2. Remove the jack and necessary tools.

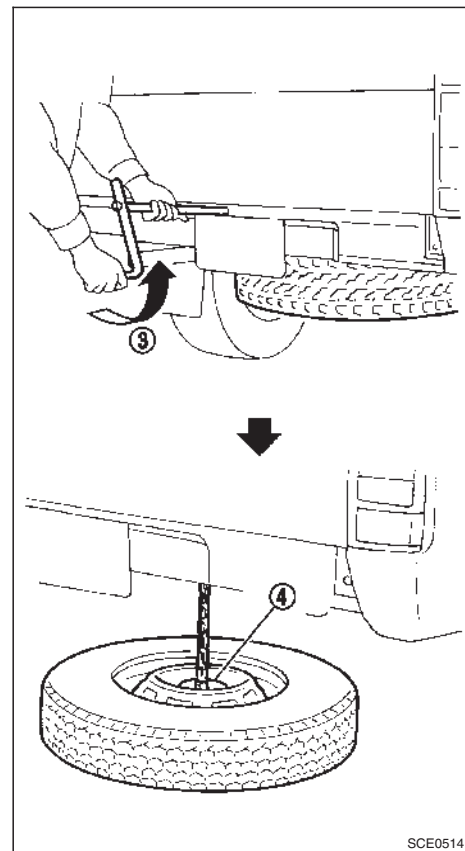
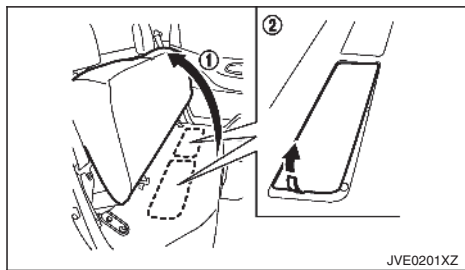

Removing the spare tyre

Find the oval shaped opening under the middle of the tailgate (where fitted) or under the number plate. Pass the T-shaped end of the jack rod through the opening and direct it towards the spare tyre winch, located directly above the spare tyre.

Seat the T-shaped end of the jack rod into the T-shaped opening of the spare tyre winch, and turn the jack rod anticlockwise ③ to lower the spare tyre.

Once the spare tyre is completely lowered ④, reach under the vehicle, remove the retainer chain, and carefully slide the tyre from under the rear of the vehicle.

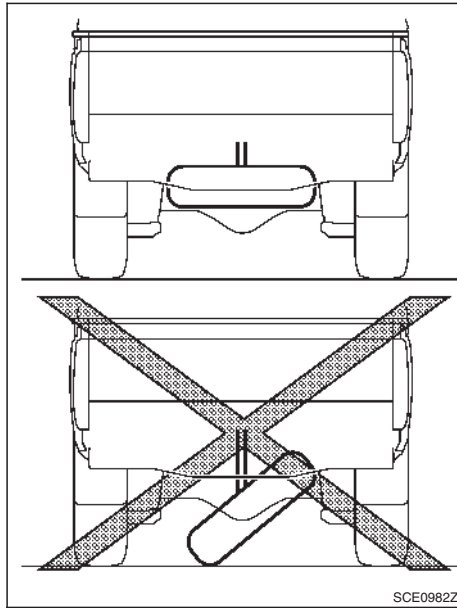

CAUTION

When storing the wheel, be sure to mount the wheel horizontally. Securing a wheel that is in a tilted position as illustrated may cause looseness and dropping of the wheel while driving. Lower the wheel on to the ground again, and make sure that the hanging plate is properly set. Hang the wheel again and make sure that the wheel is held horizontally, then store the wheel.

Blocking wheels

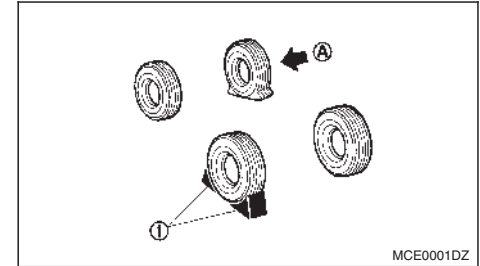

WARNING

Be sure to block the appropriate wheel to prevent the vehicle from moving, which may cause personal injury.

Place suitable blocks ① at both the front and back of the wheel diagonally opposite the flat tyre ② to prevent the vehicle from moving when it is jacked up.

Removing tyre



WARNING

Be sure to read and follow the instructions in this section.

DO NOT GET UNDER A VEHICLE THAT IS SUPPORTED BY A JACK.

Never use a jack which was not provided with your vehicle.

The jack, which is provided with your vehicle, is designed only to lift your vehicle during a tyre change.

Never jack up the vehicle at a location other than the jack-up point that is specified.

Never lift the vehicle more than necessary.

Never use blocks on or under the jack.

Never start or run the engine while the vehicle is on the jack. The vehicle may move suddenly, and this may cause an accident.

Never allow passengers to remain in the vehicle while the tyre is off the ground.

Be sure to read the caution label attached to the jack body before using.

Jacking up vehicle:

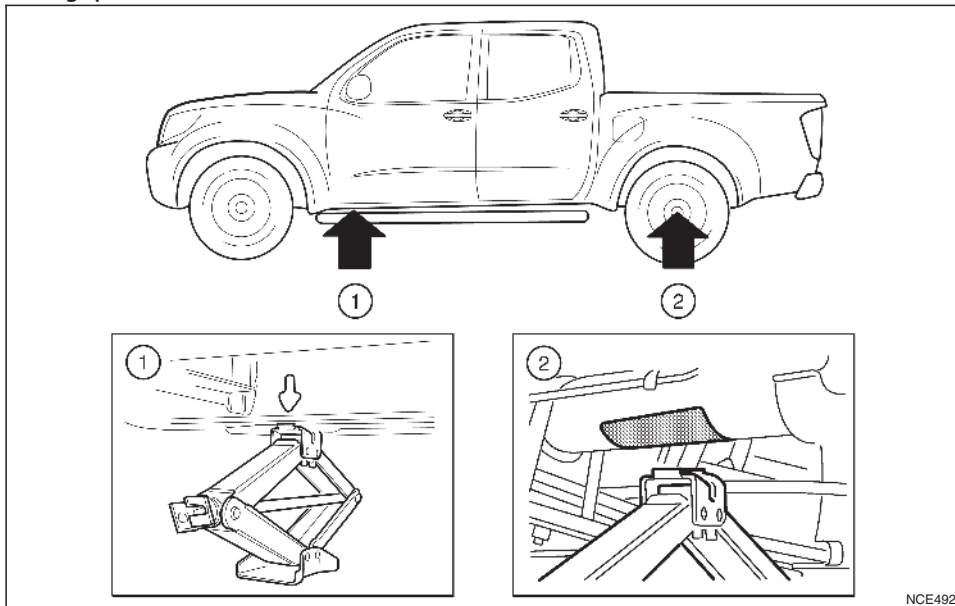

NCE492

Removing the wheel cap (where fitted):

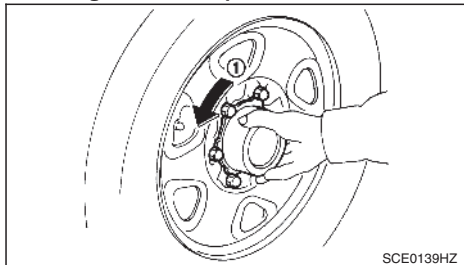

SCE0139HZ

Remove the centre wheel cap ① as illustrated.

For leaf suspension models

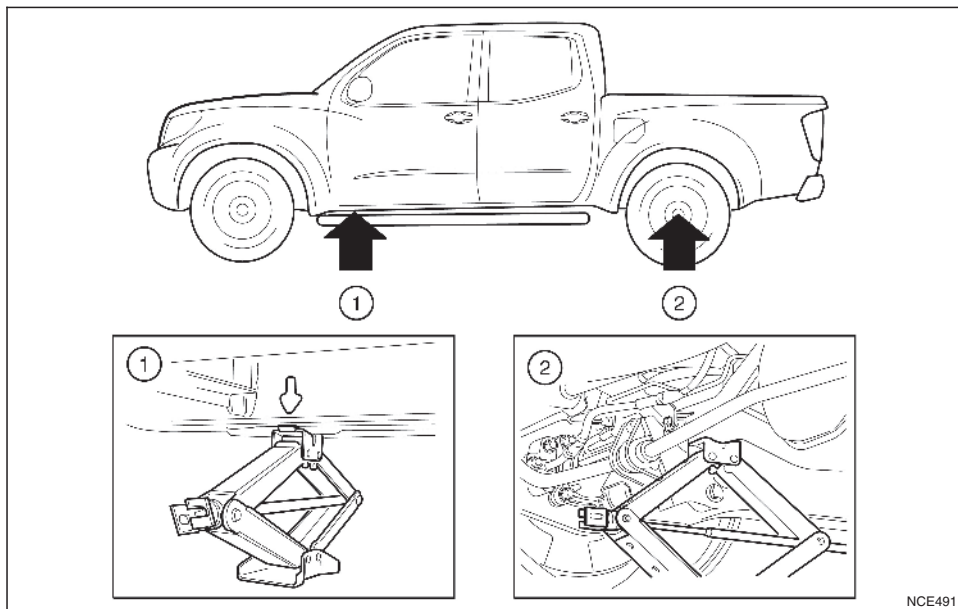

For coil suspension models

NCE491

- ① For front wheel
- ② For rear wheel

1. Place the jack directly under the jack-up points ①② as illustrated.

The jack should be placed on firm level ground.

2. Loosen each wheel nut, anticlockwise, one or two turns with the wheel nut wrench.

Do not remove the wheel nuts until the tyre is off the ground.

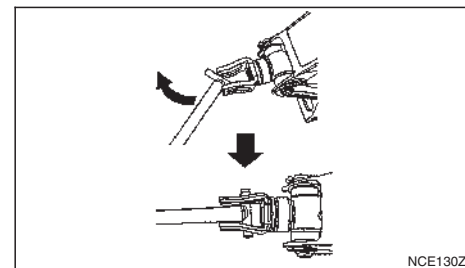

NCE130Z

3. Install the assembled jack rod into the jack as shown.
4. Carefully raise the vehicle until the clearance between the tyre and ground is achieved.
5. To lift the vehicle, securely hold the jack lever and rod with both hands and turn the jack lever.

Removing tyre:

1. Remove the wheel nuts.
2. Remove the damaged tyre.

CAUTION

The tyre is heavy. Be sure that your feet are clear from the tyre and use gloves as necessary to avoid injury.

Installing spare tyre

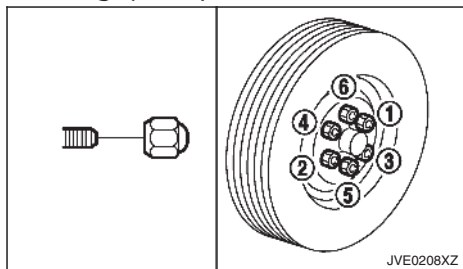

WARNING

Never use wheel nuts which are not provided with your vehicle. Incorrect wheel nuts or improperly tightened wheel nuts may cause the wheel to become loose or come off. This could cause an accident.

Never use oil or grease on the wheel studs or nuts. This may cause the wheel nuts to become loose.

1. Clean any mud or dirt from the surface between the wheel and hub.
2. Carefully put the spare tyre on and tighten the wheel nuts with your fingers. Check that all the wheel nuts contact the wheel surface horizontally.
3. Tighten the wheel nuts alternately and evenly in the sequence illustrated (① - ⑥), more than 2 times with the wheel nut wrench, until they are tight.

4. Lower the vehicle slowly until the tyre touches the ground.
5. Tighten the wheel nuts securely, with the wheel nut wrench, in the sequence illustrated.
6. Lower the vehicle completely.

Tighten the wheel nuts to the specified torque with a torque wrench as soon as possible.

Wheel nut tightening torque:
133 N·m (13.6 kg-m, 98 ft-lb)

The wheel nuts must be kept tightened to specification at all times. It is recommended that the wheel nuts be tightened to specification at each lubrication interval.



WARNING

Retighten the wheel nuts when the vehicle has been driven for 1,000 km (600 miles) (also in case of a flat tyre, etc.).

Stowing damaged tyre and tools



WARNING

Be sure that the tyre, jack and tools are properly stored after use. Such items can become dangerous projectiles in an accident or sudden stop.

Securely store the damaged tyre, jack and tools in the storage area in the reverse order of removal. (See "Preparing tools" earlier in this section.)

REPAIRING FLAT TYRE (for models with emergency tyre puncture repair kit)

The emergency tyre puncture repair kit is supplied with the vehicle instead of a spare tyre. This repair kit must be used for temporarily fixing a minor tyre puncture. After using the repair kit, see an approved dealer or qualified workshop as soon as possible for tyre inspection and repair or replacement.

CAUTION

RENAULT recommends using only Genuine RENAULT Emergency Tyre Sealant provided with your vehicle. Other tyre sealants may damage the valve stem seal which can cause the tyre to lose air pressure.

Do not use the emergency tyre puncture repair kit provided with your vehicle on other vehicles.

Do not use the emergency tyre puncture repair kit for a purpose other than to inflate and check the tyre pressure for the vehicle.

Use the emergency tyre puncture repair kit only on DC12V.

Keep water and dust off the emergency tyre puncture repair kit.

Do not disassemble or modify the emergency tyre puncture repair kit.

Do not galvanise the emergency tyre puncture repair kit.

Do not use the emergency tyre puncture repair kit under the following conditions. Contact an approved dealer or qualified workshop or professional road assistance.

- when the sealant has passed its expiration date (shown on the label attached to the bottle)
- when the cut or the puncture is approximately 6 mm (0.25 in) or longer
- when the side of the tyre is damaged
- when the vehicle has been driven with a considerable loss of air from the tyre
- when the tyre is completely displaced inside or outside the rim
- when the tyre rim is damaged
- when two or more tyres are flat

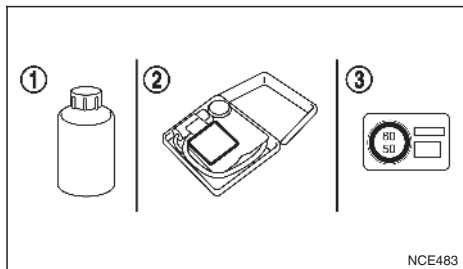

Getting emergency tyre puncture repair kit

Take the emergency tyre puncture repair kit from its storage position under the left rear seat. The repair kit consists of the following items:

- ① Tyre sealant bottle
- ② Air compressor
- ③ Speed restriction sticker

NOTE

For models with the emergency tyre puncture repair kit, a spare tyre, jack and rod are not equipped as standard. These parts are dealer options. Contact an approved dealer or qualified workshop about obtaining these parts. See "Changing flat tyre (for models with spare tyre)" earlier in this section for usage of jacking tools and tyre replacement.

Before using emergency tyre puncture repair kit

If any foreign object (for example, a screw or nail) is embedded in the tyre, do not remove it.

Check the expiration date of the sealant (shown on the label attached to the bottle). Never use a sealant whose expiration date has passed.

Repairing tyre



WARNING

Observe the following precautions when using the emergency tyre puncture repair kit.

Swallowing the compound is dangerous. Immediately drink as much water as possible and seek prompt medical assistance.

Rinse well with lots of water if the compound comes into contact with skin or eyes. If irritation persists, seek prompt medical attention.

Keep the repair compound out of the reach of children.

The emergency repair compound may cause a malfunction of the tyre pressure sensors (where fitted) and cause the low tyre pressure warning light (where fitted) to illuminate. Have the tyre pressure sensor replaced as soon as possible.

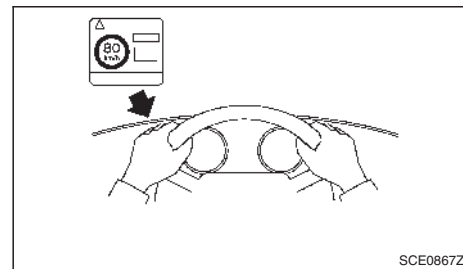

1. Remove the speed restriction sticker from the compressor*, then place it in a location where the driver can see it while driving.

*: The compressor shape may differ depending on the model.

CAUTION

Do not put the speed restriction label on the steering wheel pad, the speedometer or the warning light locations.

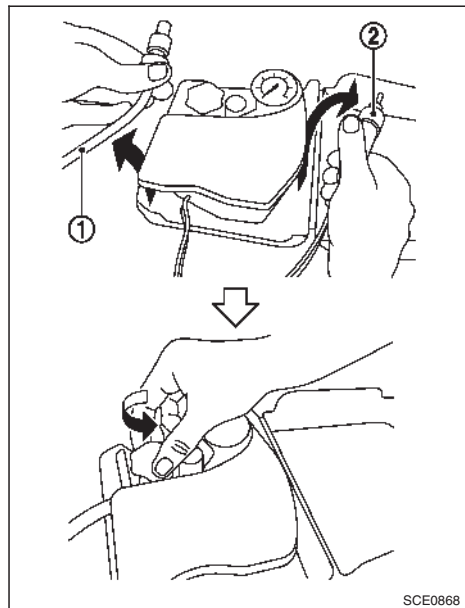

2. Take the hose ① and the power plug ② out of the air compressor. Remove the cap of the bottle holder from the air compressor.

3. Remove the cap of the tyre sealant bottle.

NOTE

Leave the bottle seal intact. Screwing the bottle onto the bottle holder will pierce the seal of the bottle.

4. Screw the bottle clockwise onto the bottle holder of the air compressor.
5. Remove the cap of the tyre valve on the flat tyre.

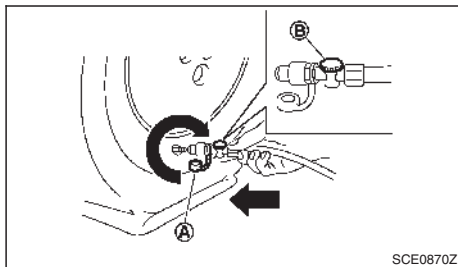

6. Remove the protective cap of the hose and screw the air tube A of the compressor securely onto the tyre valve. Make sure that the air compressor switch is in the "OFF" (O) position and the pressure release valve B is securely closed, then insert its power plug into the power outlet in the vehicle.

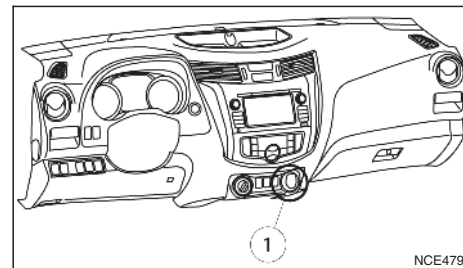

NOTE

Use the power socket located on the lower part of the cockpit ①.

7. Check the specified tyre pressure on the tyre placard that is affixed to the driver's side centre pillar.
8. Place the ignition switch in the ACC position. Then turn the compressor switch to the ON (-) position and inflate the tyre up to the pressure that is specified on the tyre placard affixed to the driver's side centre pillar if possible, or to the minimum of 180 kPa (1.8 bar, 26 psi), for tyre 205R16 250 kPa (2.5 bar, 36 psi). Turn the air compressor off briefly in order to check the tyre pressure with the pressure gauge.

If the tyre is inflated to higher than the specified pressure, adjust the tyre pressure by releasing air with the pressure release valve. The cold tyre pressures are shown on the tyre placard affixed to the driver's side centre pillar.



WARNING

To avoid serious personal injury while using the emergency tyre puncture repair kit.

Securely tighten the compressor hose to the tyre valve. Failure to do so can cause the sealant to spray into the air and get into your eyes or on your skin.

Do not stand directly beside the damaged tyre while it is being inflated because of the risk of rupture. If there are any cracks or bumps, turn the compressor off immediately.

CAUTION

Do not operate the compressor for more than 10 minutes. If the tyre pressure does not increase to the specified pressure within 10 minutes, the tyre may be seriously damaged and the tyre cannot be repaired with this tyre repair kit. Contact an approved dealer or qualified workshop.

- When the tyre pressure is at the specified value, close the pressure release valve and turn the air compressor off. If the pressure cannot be inflated to the specified value, the air compressor can be turned off at the minimum of 180 kPa (1,8 bar, 26 psi) for tyre 205R16 250 kPa (2,5 bar, 36 psi). Remove the power plug from the power outlet and quickly remove the hose from the tyre valve. Attach the protective cap and valve cap. Properly stow the emergency tyre puncture repair kit in the storage location.



WARNING

To avoid serious personal injury when stowing the emergency tyre puncture repair kit, keep the sealant bottle screwed into the compressor. Failure to do so can cause the sealant to spray into the air and get into your eyes or on the skin.

- Immediately drive the vehicle for 10 minutes or 3–10 km (2–6 miles) (if the road situation allows) at a speed of **80 km/h (50 MPH) or less**.
- After driving 10 km (6 miles), or 10 minutes, screw the air tube of the air compressor securely onto the tyre valve. Check the tyre pressure with the pressure gauge.

The temporary repair is completed if the tyre pressure does not drop.

Make sure the pressure is adjusted to the pressure that is specified on the tyre placard before driving.

If the tyre pressure drops under 130 kPa (19 psi): The tyre cannot be repaired with this tyre puncture repair kit. Contact an approved dealer or qualified workshop.

If the tyre pressure is 130 kPa (19 psi) or more but less than the specified pressure:

Turn the compressor switch to the ON (-) position and inflate the tyre up to the specified pressure. Then repeat the step from 8.

If the pressure drops again, **the tyre cannot be repaired with this tyre puncture repair kit.** Contact an approved dealer or qualified workshop.

When the tyre pressure is the specified pressure:

The temporary repair is completed.

See an approved dealer or qualified workshop for the repair/replacement as soon as possible.

After repairing tyre

See an approved dealer or qualified workshop for tyre repair or replacement and for a new tyre sealant bottle and hose, as soon as possible.

CAUTION

Before driving, ensure tyre is adjusted to recommended inflation pressure as indicated on vehicle placard. Monitor tyre pressure until sealed tyre is replaced.

Do not drive the vehicle at speeds faster than 50 MPH (80 km/h), and the damaged tyre must be replaced as quickly as possible (within a maximum driving distance of 200 km (120 miles)). You must not continue to drive if heavy vibrations, unsteady steering behaviour or noises should occur while driving.

Immediately after using Emergency Tyre Sealant to repair a minor tyre puncture, take your vehicle to an approved dealer or qualified workshop to inspect, and repair or replace the tyre. The Emergency Tyre Sealant cannot permanently seal a punctured tyre. Continuing operation of the vehicle without a permanent tyre repair can lead to a crash.

RENAULT recommends using only RENAULT Genuine Emergency Tyre Sealant provided with your vehicle. Other tyre sealants may damage the valve stem seal which can cause the tyre to lose air pressure.

JUMP STARTING



WARNING

Incorrect jump starting can lead to a battery explosion. The battery explosion may result in severe injury or death. It may also result in damage to the vehicle. Be sure to follow the instructions in this section.

Explosive hydrogen gas is always present in the vicinity of the battery. Keep all sparks and flames away from the battery.

Always wear suitable eye protection and remove rings, bracelets, and any other jewellery whenever working on or near a battery.

Never lean over the battery while jump starting.

Never allow battery fluid to come into contact with eyes, skin, clothes or the vehicle's painted surfaces. Battery fluid is a corrosive sulphuric acid which can cause severe burns. If the fluid comes into contact with anything, immediately flush the contacted area with plenty of water.

Keep the battery out of the reach of children.

The booster battery must be rated at 12 volts. Use of an incorrectly rated battery will damage your vehicle.

Never attempt to jump start a frozen battery. It could explode and cause serious injury.

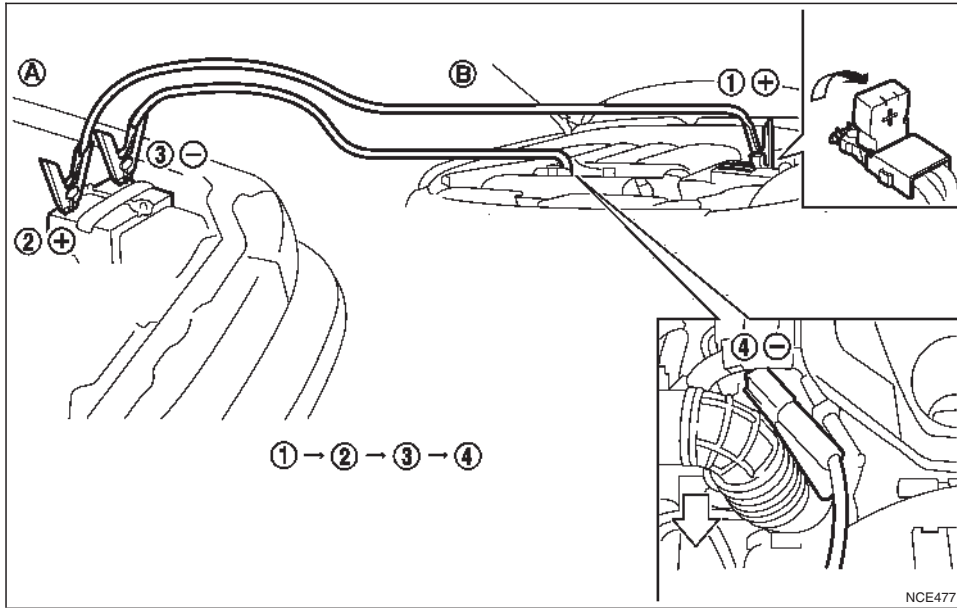

M9T 2.3DCI engine models

NCE477

1. If the booster battery is in another vehicle (A), position the two vehicles (A) and (B) to bring the batteries into close proximity to each other.

CAUTION

Do not allow the two vehicles to touch.

If the battery of vehicle (B) equipped with the Remote Control Key system is discharged, the steering wheel will lock and cannot be turned with the ignition switch in the OFF position. Supply power using jumper cables before pushing the ignition switch to any position other than the OFF position and disengaging the steering lock.

2. Apply the parking brake.
3. **Automatic transmission (AT) model:**
Move the shift lever to the P (Park) position.
Manual transmission (MT) model:
Move the shift lever to the N (Neutral) position.
4. Switch off all unnecessary electrical systems (headlights, heater, air conditioner, etc.).
5. Place the ignition switch in the **OFF** position.
6. Remove the vent caps, where fitted, on the battery.
7. Cover the battery with a firmly wrung out moist cloth to reduce the hazard of an explosion.
8. Connect the jumper cables in the sequence as illustrated (1, 2, 3, 4).

CAUTION

Always connect positive (+) to positive (+) and negative (-) to body ground, NOT to the battery's negative (-).

Be sure that the jumper cables do not touch moving parts in the engine compartment.

Be sure that the jumper cable's clamps do not contact any other metal.

9. Start the engine of the booster vehicle (A) and let it run for a few minutes.
10. Depress the accelerator pedal of the booster vehicle (A) to race the engine at about 2,000 rpm.

PUSH STARTING

11. Start the engine of the jumped vehicle  in the normal manner.

CAUTION

Never keep the starter motor engaged for more than 10 seconds. If the engine does not start right away, place the ignition switch in the "LOCK" position and wait at least 10 seconds before trying again.

12. After the engine is started, carefully disconnect the jumper cables in the opposite sequence from that illustrated (④, ③, ②, ①).
13. Remove and dispose of the cloth properly as it may be contaminated with corrosive acid.
14. Replace the vent caps, if removed.

Do not attempt to start the engine by pushing the vehicle.

CAUTION

Automatic Transmission (AT) model cannot be started by pushing. Attempting to do so may cause damage to the transmission.

Three-way catalyst equipped model should not be started by pushing. Attempting to do so may cause damage to the three-way catalyst.

Diesel Oxidation Catalyst equipped model should not be started by pushing. Attempting to do so may cause damage to the catalyst.

Never try to start the engine by towing. When the engine starts, the forward surge could cause the vehicle to collide with the towing vehicle.

IF YOUR VEHICLE OVERHEATS



WARNING

Never continue driving if your vehicle overheats. Doing so could cause engine damage and/or a vehicle fire.

Never open the bonnet if steam is coming out.

Never remove the radiator or coolant reservoir cap while the engine is hot. If the radiator or coolant reservoir cap is removed when the engine is hot, pressurised hot water will spurt out and possibly cause burning, scalding or serious injury.

If steam or coolant is coming from the engine, stand clear of the vehicle to prevent getting scalded.

The engine cooling fan can start at any time when the coolant temperature exceeds preset degrees.

Be careful not to allow your hands, hair, jewellery or clothing to come into contact with, or to get caught in the cooling fan or drive belts.

If your vehicle is overheating, or if you feel a lack of engine power, detect unusual noise, etc., take the following steps:

1. Safely move the vehicle off the road away from traffic.
2. Turn on the hazard indicator flashers.
3. Apply the parking brake.
4. **Automatic transmission model:**
Move the shift lever to the P (Park) position.

TOWING YOUR VEHICLE

Manual transmission model:

Move the shift lever to the N (Neutral) position.

DO NOT STOP THE ENGINE.

5. Open all the windows.
6. Turn off the air conditioner. Move the temperature control to maximum hot and the fan control to high speed.
7. Get out from the vehicle.
8. Visually inspect and listen for steam or coolant escaping from the radiator before opening the bonnet. Wait until no steam or coolant can be seen before proceeding.
9. Open the engine bonnet.
10. Visually inspect if the cooling fan is running.
11. Visually inspect the radiator and radiator hoses for leakage. If the cooling fan is not running or the coolant is leaking, stop the engine.
12. After the engine cools down, check the coolant level in the reservoir with the engine running. **Do not open the radiator or coolant reservoir cap.**
13. Add coolant to the reservoir if necessary.

Have your vehicle inspected/repared at an approved dealer or qualified workshop.

When towing your vehicle, local regulations for towing must be followed. Incorrect towing equipment could damage your vehicle. To assure proper towing and to prevent accidental damage to your vehicle, RENAULT recommends that you have professional road assistance personnel tow your vehicle. It is advisable to have the professional road assistant carefully read the following precautions.

TOWING PRECAUTIONS

Be sure that the transmission, steering system and powertrain are in working condition before towing. If any units are damaged, the vehicle must be towed using a dolly or flatbed tow truck. (Two- Wheel Drive (2WD) model)

RENAULT recommends that your vehicle be towed with the driving wheels off the ground. (Two- Wheel Drive (2WD) model)

To tow a vehicle with automatic transmission, and appropriate vehicle dolly **MUST** be placed under the towed vehicles drive wheels. Always follow the dolly manufacturer's recommendations when using their product.

Always attach safety chains before towing.

Never tow Four-Wheel Drive (4WD) model with any of the wheels on the ground as this may cause serious and expensive damage to the drivetrain.

TOWING RECOMMENDED BY RENAULT

Towing Two-Wheel Drive (2WD) models

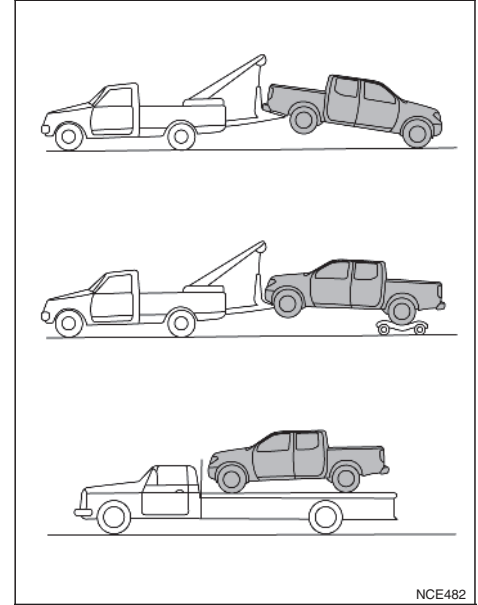

Front wheels on the ground:

1. Place the ignition switch in the ON position and turn all accessories off.

2. Secure the steering wheel in a straight ahead position with rope or similar device.
3. Move the shift lever to the N (Neutral) position.
4. Release the parking brake.
5. Attach safety chains before towing.

Rear wheels on the ground:

RENAULT recommends that towing dollies be used under the rear wheels when towing your vehicle or the vehicle be placed on a flatbed tow truck as illustrated.

CAUTION

Never tow Automatic Transmission (AT) model with the rear wheels on the ground. Doing so will cause serious and expensive damage to the transmission.

Manual Transmission (MT) model:

If you have to tow a vehicle with rear wheels on the ground, perform the following procedures.

CAUTION

Observe the following restricted towing speeds and distances.

Speed: Below 50 km/h (30 MPH)

Distance: Less than 65 km (40 miles)

1. Place the ignition switch in the ON position and turn all accessories off.
2. Move the shift lever to the N (Neutral) position.
3. Release the parking brake.
4. Attach safety chains whenever towing.

All four wheels on the ground:

RENAULT recommends that the vehicle be placed on a flatbed tow truck as illustrated.

CAUTION

Never tow Automatic Transmission (AT) model with all four wheels on the ground. Doing so will cause serious and expensive damage to the drivetrain.

Manual Transmission (MT) model:

If you have to tow a vehicle with all four wheels on the ground, perform the following procedures.

CAUTION

Never tow a Manual Transmission (MT) model backwards with all four wheels on the ground.

Observe the following restricted towing speeds and distances.

- **Speed: Below 50 km/h (30 MPH)**
- **Distance: Less than 65 km (40 miles)**

1. Place the ignition switch in the ON position and turn all accessories off.
2. Move the shift lever to the N (Neutral) position.
3. Release the parking brake.

Towing Four-Wheel Drive (4WD) models

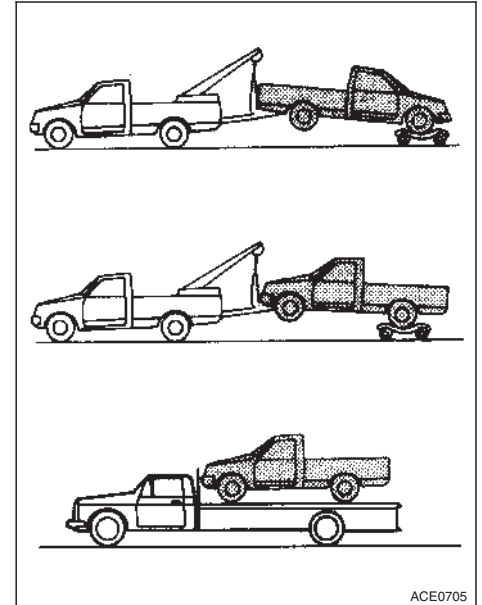

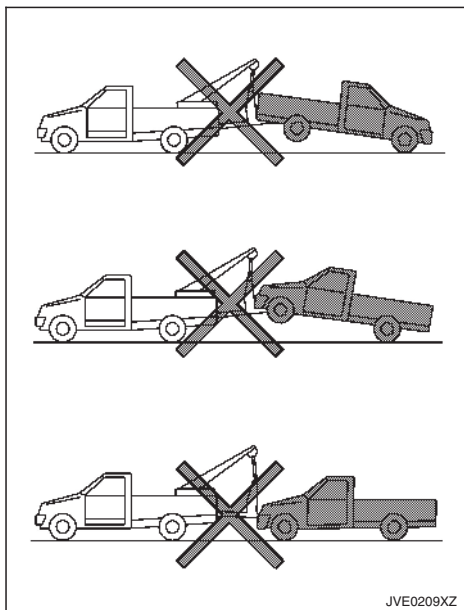

Freeing trapped vehicle

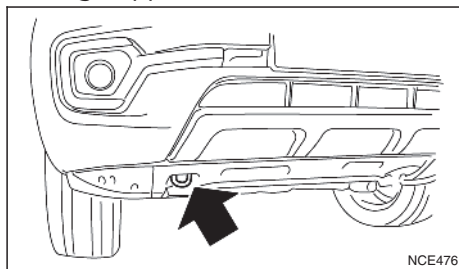

WARNING

Never allow anyone to stand near the towing line during the pulling operation.

Never spin the tyres at high speed. This could cause them to explode and result in serious injury. Parts of the vehicle could also overheat and be damaged.

In the event that your vehicle's tyres become trapped in sand, snow, or mud, and the vehicle is unable to free itself without being pulled, use the towing eye.

Use the towing eye only. Do not attach the pulling device to any other part of the vehicle body. Otherwise, the vehicle body may be damaged.

Use the towing eye to free a vehicle only. Never tow a vehicle using only the towing eye.

The towing eye is under tremendous stress when used to free a trapped vehicle. Always pull the pulling device straight out from the vehicle. Never pull on the towing eye at an angle.

CAUTION

In order to not break the towing line, tension it slowly.

RENAULT recommends that your vehicle be towed with all wheels off the ground as illustrated or place the vehicle on a flatbed truck.

CAUTION

Never tow 4WD models with any of the wheels on the ground. Doing so will cause serious and expensive damage to the drivetrain.

7 Appearance and care

Cleaning exterior.....	7-2	Air fresheners.....	7-4
Washing.....	7-2	Floor mats.....	7-4
Removing spots.....	7-2	Glass.....	7-4
Waxing.....	7-3	Seat belts.....	7-5
Glass.....	7-3	Corrosion protection.....	7-5
Underbody.....	7-3	Most common factors contributing to vehicle	
Wheels.....	7-3	corrosion.....	7-5
Aluminium alloy wheels.....	7-3	Environmental factors influence the rate of	
Side step boards.....	7-3	corrosion.....	7-5
Chrome parts.....	7-3	To protect your vehicle from corrosion.....	7-5
Cleaning interior.....	7-4		

CLEANING EXTERIOR

In order to maintain the appearance of your vehicle, it is important to take proper care of it.

Whenever possible, park your vehicle inside a garage or in a covered area to minimise the chances of damaging the paint surface of your vehicle.

When it is necessary to park outside, park in a shady area or protect the vehicle with a body cover. **Be careful not to scratch the paint surface when putting on or removing the body cover.**

WASHING

In the following instances, wash your vehicle as soon as possible to protect the paint surface:

After a rainfall, which may cause the paint surface damage from acid rain.

After driving on coastal roads, which may cause rusting from the sea breeze.

When contaminants such as soot, bird droppings, tree sap, metal particles or bugs get on the paint surface.

When dust or mud builds up on the paint surface.

1. Wash the vehicle surface with a wet sponge and plenty of water.
2. Clean the vehicle surface gently and thoroughly using a mild soap, a special vehicle soap or a general purpose dishwashing liquid mixed with clean, lukewarm (never hot) water.

CAUTION

Do not wash the vehicle with strong household soap, strong chemical detergents, petrol or solvents.

Do not wash the vehicle in direct sunlight or while the vehicle body is hot, as the paint surface may become water-spotted.

Avoid using tight-napped or rough cloths, such as washing mitts. Care must be taken when removing caked-on dirt or other foreign substances so the paint surface is not scratched or damaged.

Lock all doors before going through automatic car wash. Locking doors helps prevent fuel filler lid from opening and becoming damaged.

3. Rinse the vehicle thoroughly with plenty of clean water.
4. Use a dampened chamois to dry the paint surface and avoid leaving water spots.

When washing the vehicle, take care of the following:

Inside flanges, joints and folds on the doors, hatches and bonnet are particularly vulnerable to the effects of road salt. Therefore, these areas must be cleaned regularly.

Be sure that the drain holes in the lower edge of the doors are not clogged.

Spray water on the underbody and in the wheel wells to loosen the dirt and/or wash away road salt.

STICKERS, BADGES, STRIPES OR GRAPHICS (where fitted)

To maintain the premium anodized finish of personalised stickers, stripes and graphics on your vehicle, please observe the following care points:

Only hand wash the surface, using PH neutral detergents.

Do not use an automated car wash.

Do not use chemical agents (abrasive products, polishes, petrol, wax, protective products, corrosive solvents, etc).

Wash your vehicle as soon as you can if any insects, bird droppings, soot or metallic particles appear on the paint surface.

The anodized finish may deteriorate if its touched by bare hands or marked by road oil (tar, etc.). Wash any dirt off the vehicle with a wet microfibre cloth and plenty of clean water.

Avoid parking your vehicle under trees and remove any tree sap as soon as possible.

Gently wash stickers using a clean sponge. Do not use a pressure washer.

REMOVING SPOTS

Remove tar and oil spots, industrial dust, insects, and tree sap as quickly as possible from the paint surface to avoid lasting damage or staining. Special cleaning products are available at an approved dealer or any automotive accessory store.

WAXING

Regular waxing protects the paint surface and helps maintain a new vehicle appearance.

After waxing, polishing is recommended to remove built-up residue and to avoid a weathered appearance.

An approved dealer can assist you in choosing the appropriate waxing products.

CAUTION

Wash your vehicle thoroughly and completely before applying wax to the paint surface.

Always follow the manufacturer's instructions supplied with the wax.

Do not use a wax containing any abrasives, cutting compounds or cleaners that may damage the vehicle finish.

Machine compounding or aggressive polishing on a base coat/clear coat paint finish may dull the finish or leave swirl marks.

GLASS

Use glass cleaner to remove smoke and dust film from the glass surfaces. It is normal for glass to become coated with a film after the vehicle is parked in the hot sun. Glass cleaner and a soft cloth will easily remove this film.

UNDERBODY

In areas where road salt is used in the winter, it is necessary to clean the vehicle's underbody regularly in order to prevent dirt and salt from building up and causing the acceleration of corrosion on the underbody and suspension.

Before the winter and again in the spring, the underseal must be checked and, if necessary, re-treated.

WHEELS

Wash the wheels when washing the vehicle to maintain their appearance.

Clean the inner side of the wheels when the wheel is changed or the underside of the vehicle is washed.

Do not use abrasive cleaners when washing the wheels.

Inspect wheel rims regularly for dents or corrosion. This may cause loss of pressure or damage the tyre bead.

RENAULT recommends that the road wheels be waxed to protect against road salt in areas where it is used during winter.

ALUMINIUM ALLOY WHEELS

Wash the wheels regularly with a sponge dampened in a mild soap solution, especially during winter in areas where road salt is used. The salt residue from road salt could discolour the wheels if it is not washed off regularly.

CAUTION

Follow the directions below to avoid staining or discolouring the wheels:

Do not use a cleaner that uses strong acid or alkali contents to clean the wheels.

Do not apply wheel cleaners to the wheels when they are hot. The wheel temperature should be the same as ambient temperature.

Rinse the wheel to completely remove the cleaner within 15 minutes after the cleaner is applied.

SIDE STEP BOARDS

CAUTION

When cleaning the side step boards, follow the instruction below:

Do not use a cleaner that uses strong acid or alkali contents to clean the side step boards. Using strong acid or alkali contents may damage the side step board surface.

Rinse the side step boards to completely remove the cleaner within 15 minutes after the cleaner is applied.

CHROME PARTS

Clean all chrome parts regularly with a non abrasive chrome polish to maintain the finish.

CLEANING INTERIOR

Occasionally remove loose dust from the interior trim, plastic parts and seats using a vacuum cleaner or soft bristled brush. Wipe the vinyl and leather surfaces with a clean, soft cloth dampened in mild soap solution, then wipe clean with a dry, soft cloth.

Regular care and cleaning is required in order to maintain the appearance of the leather.

Before using any fabric protector, read the manufacturer's recommendations. Some fabric protectors contain chemicals that may stain or bleach the seat material.

Use a soft cloth dampened only with water to clean the meter and gauge lens covers.

CAUTION

Never use benzene, thinner or any similar material.

Small dirt particles can be abrasive and damaging to leather surfaces and should be removed promptly. Do not use saddle soap, car waxes, polishes, oils, cleaning fluids, solvents, detergents or ammonia-based cleaners as they damage the natural leather finish.

Never use fabric protectors unless recommended by the manufacturer.

Do not use glass or plastic cleaner on meter or gauge lens covers. It may damage the lens covers.

AIR FRESHENERS

Most air fresheners use a solvent that could affect the vehicle interior. If you use an air freshener, take the following precautions:

Hanging-type air fresheners can cause permanent discoloration when they contact vehicle interior surfaces. Place the air freshener in a location that allows it to hang free and not contact an interior surface.

Liquid-type air fresheners typically clip on the vents. These products can cause immediate damage and discoloration when spilled on interior surfaces.

Carefully read and follow the manufacturer's instructions before using air fresheners.

FLOOR MATS

The use of floor mats (where fitted) can extend the life of your vehicle carpet and make it easier to clean the interior. Regardless of what mats are used, be sure they are fitted for your vehicle and are properly positioned in the foot well to prevent interference with pedal operation. Mats should be maintained with regular cleaning and replaced if they become excessively worn.

Floor mat positioning aid

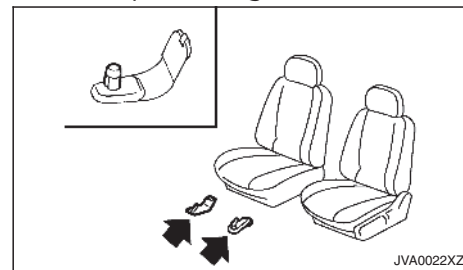

Example

This vehicle includes floor mat brackets to act as a floor mat positioning aid.

Position the mat by placing the floor mat bracket hook through the floor mat's hole while centering the mat in the foot area.

Periodically check that the mats are properly positioned.

GLASS

Use glass cleaner to remove smoke and dust film from the glass surfaces. It is normal for glass to become coated with a film after the vehicle is parked in the hot sun. Glass cleaner and a soft cloth will easily remove this film.

CAUTION

When cleaning the inside of the windows, do not use sharp-edged tools, abrasive cleaners or chlorine-based disinfectant cleaners. They could damage the electrical conductors, such as radio antenna elements or rear window defogger elements.

CORROSION PROTECTION

SEAT BELTS



WARNING

Do not allow wet seat belts to roll up in the retractor.

Never use bleach, dye or chemical solvents to clean the seat belts, since these materials may severely weaken the seat belt webbing.

The seat belts can be cleaned by wiping them with a sponge dampened in a mild soap solution.

Allow the belts to dry completely in the shade before using them. (See “Seat belts” in the “1. Safety – seats, seat belts and supplemental restraint system” section.)

MOST COMMON FACTORS CONTRIBUTING TO VEHICLE CORROSION

The accumulation of moisture-retaining dirt and debris in body panel sections, cavities, and other areas.

Damage to the paint surface and other protective coatings caused by gravel and stone chips or minor traffic accidents.

ENVIRONMENTAL FACTORS INFLUENCE THE RATE OF CORROSION

Moisture

The accumulation of sand, dirt and water on the inside floor of the vehicle can accelerate corrosion. Wet floor carpet/floor mats will not dry completely inside the vehicle. They should be removed and completely dried to avoid floor panel corrosion.

Relative humidity

Corrosion will be accelerated in areas of high relative humidity.

Temperature

High temperatures accelerate the rate of corrosion to those parts which are not well ventilated.

Corrosion will also be accelerated in areas where the temperatures stay above freezing.

Air pollution

Industrial pollution, the presence of salt in the air in coastal areas, or heavy road salt use accelerates the corrosion process. Road salt also accelerates the disintegration of paint surfaces.

TO PROTECT YOUR VEHICLE FROM CORROSION

Wash and wax your vehicle often to keep the vehicle clean.

Always check for minor damage to the paint surface and if any exists, repair it as soon as possible.

Keep the drain holes in the lower edge of the doors open to avoid water accumulation.

Check the vehicle underbody for accumulation of sand, dirt or salt. If present, wash with water as soon as possible.

CAUTION

Never remove dirt, sand or other debris from the passenger compartment by washing it out with a hose. Remove dirt with a vacuum cleaner.

Never allow water or other liquids to come in contact with electronic components inside the vehicle as this may damage them.

Chemicals used for road surface de-icing are extremely corrosive. They accelerate corrosion and deterioration of underbody components such as the exhaust system, fuel and brake lines, brake cables, floor pan and wings.

In the winter, the underbody must be cleaned periodically.

For additional protection against rust and corrosion, which may be required in some areas, consult an approved dealer or qualified workshop.

8 Maintenance and do-it-yourself

Maintenance requirements.....	8-2	Window washer fluid.....	8-11
Scheduled maintenance.....	8-2	Battery.....	8-12
General maintenance.....	8-2	Vehicle battery.....	8-13
Where to go for service.....	8-2	Remote controller battery (where fitted).....	8-13
General maintenance.....	8-2	Remote Control Key battery (where fitted).....	8-14
Explanation of general maintenance items.....	8-2	Air cleaner filter.....	8-15
Maintenance precautions.....	8-4	Wiper blades.....	8-16
Engine compartment check locations.....	8-5	Windscreen wiper blades.....	8-16
Engine cooling system.....	8-5	Variable voltage control system (where fitted).....	8-17
Checking engine coolant level.....	8-6	Fuses.....	8-18
Changing engine coolant.....	8-6	Engine compartment.....	8-18
Engine oil.....	8-6	Passenger compartment.....	8-19
Checking engine oil level.....	8-6	Lights.....	8-21
Changing engine oil and oil filter.....	8-7	Headlights.....	8-21
Protect environment.....	8-7	Exterior lights.....	8-22
AdBlue® tank (where fitted for diesel engine model).....	8-7	Interior lights.....	8-22
Refilling the AdBlue® tank.....	8-7	Light locations.....	8-23
Drive belt.....	8-8	Tyres and wheels.....	8-27
Automatic Transmission Fluid (ATF) (where fitted).....	8-8	Tyre inflation pressure.....	8-27
7-speed Automatic Transmission (AT) model.....	8-8	Types of tyres.....	8-27
Power steering fluid.....	8-8	Tyre chains.....	8-27
Brakes.....	8-9	Tyre rotation.....	8-28
Checking parking brake.....	8-9	Tyre wear and damage.....	8-28
Checking footbrake.....	8-9	Tyre age.....	8-28
Brake booster.....	8-9	Changing tyres and wheels.....	8-28
Brake fluid.....	8-10	Wheel balance.....	8-29
Clutch fluid (where fitted).....	8-11	Spare tyre.....	8-29

MAINTENANCE REQUIREMENTS

Some day-to-day and regular maintenance is essential to maintain your vehicle's good mechanical condition, as well as its emission and engine performance.

It is the owner's responsibility to make sure that the specified maintenance, as well as general maintenance, is performed.

As the vehicle owner, you are the only one who can ensure that your vehicle receives the proper maintenance care.

SCHEDULED MAINTENANCE

For your convenience, the required scheduled maintenance items are described and listed in a separate Warranty Information and Maintenance booklet. You must refer to that booklet to ensure that necessary maintenance is performed on your vehicle at regular intervals.

GENERAL MAINTENANCE

General maintenance includes those items which should be checked during normal day-to-day operation of the vehicle. They are essential if your vehicle is to continue to operate properly. It is your responsibility to perform these procedures regularly as prescribed.

Performing general maintenance checks requires minimal mechanical skill and only a few general automotive tools.

These checks or inspections can be done by yourself, a qualified technician, or if you prefer, your approved dealer or qualified workshop.

WHERE TO GO FOR SERVICE

If maintenance service is required or your vehicle appears to malfunction, have the systems checked and tuned by an authorised approved dealer or qualified workshop.

GENERAL MAINTENANCE

During normal day-to-day operation of the vehicle, general maintenance should be performed regularly as prescribed in this section. If you detect any unusual sounds, vibrations or smells, be sure to check for the cause or have an approved dealer or qualified workshop do it promptly. In addition, you should notify an approved dealer or qualified workshop if you think that repairs are required.

When performing any checks or maintenance work, closely observe "Maintenance precautions" later in this section.

EXPLANATION OF GENERAL MAINTENANCE ITEMS

Additional information on the following items with "*" is found later in this section.

Outside vehicle

The maintenance items listed here should be performed from time to time, unless otherwise specified.

Doors and bonnet:

Check that all doors and the bonnet operate smoothly as well as the tailgate. Also make sure that all latches lock securely. Lubricate if necessary. Make sure that the secondary latch keeps the bonnet from opening when the primary latch is released. When driving in areas using road salt or other corrosive materials, check lubrication frequently.

Lights*:

Clean the headlights on a regular basis. Make sure that the headlights, stop lights, tail lights, turn signal lights, and other lights are all operating properly and installed securely. Also check the aim of the headlights.

Tyres*:

Check the pressure with a gauge often and always prior to long distance trips. Adjust the pressure in all tyres, including the spare, to the pressure specified. Check carefully for damage, cuts or excessive wear.

Tyre rotation*:

In the case of Two-Wheel Drive (2WD), and where front and rear tyres are the same size: tyres should be rotated every 10,000 km (6,000 miles). Tyres marked with directional indicators can only be rotated between front and rear. Make sure that the directional indicators point in the direction of wheel rotation after the tyre rotation is completed.

In the case of the Four-Wheel Drive and All Wheel Drive (4WD/AWD), and where front and rear tyres are the same size: tyres should be rotated every 5,000 km (3,000 miles). Tyres marked with directional indicators can only be rotated between front and rear. Make sure that the directional indicators point in the direction of wheel rotation after the tyre rotation is completed.

In the case that front tyres are different size from rear tyres: tyres cannot be rotated.

The timing for tyre rotation may vary according to your driving habits and the road surface conditions.

Wheel alignment and balance:

If the vehicle should pull to either side while driving on a straight and level road, or if you detect uneven or abnormal tyre wear, there may be a need for wheel alignment. If the steering wheel or seat vibrates at normal highway speeds, wheel balancing may be needed.

Windscreen:

Clean the windscreen on a regular basis. Check the windscreen at least every six months for cracks or other damage. Repair as necessary.

Wiper blades*:

Check for cracks or wear if not functioning correctly. Replace as necessary.

Inside vehicle

The maintenance items listed here should be checked on a regular basis, such as when performing periodic maintenance, cleaning the vehicle, etc.

Accelerator pedal:

Check the pedal for smooth operation and make sure that the pedal does not catch or require uneven effort. Keep the floor mats away from the pedal.

Brake pedal*:

Check the pedal for smooth operation and make sure that it is the proper distance from the floor mat when depressed fully. Check the brake booster function. Be sure to keep the floor mats away from the pedal.

Parking brake*:

Check the parking brake operation regularly. Check that the lever (where fitted) or the pedal (where fitted) has the proper travel. Also make sure that the vehicle is held securely on a fairly steep hill when only the parking brake is applied.

Seat belts:

Check that all parts of the seat belt system (for example, buckles, anchors, adjusters and retractors) operate properly and smoothly, and are installed securely. Check the belt webbing for cuts, fraying, wear or damage.

Steering wheel:

Check for changes in the steering condition, such as excessive play, hard steering or strange noises.

Warning lights and chimes:

Make sure that all warning lights and chimes are operating properly.

Windscreen defogger:

Check that the air comes out of the defogger outlets properly and in good quantity when operating the heater or air conditioner.

Windscreen wiper and washer*:

Check that the wipers and washer operate properly and that the wipers do not streak.

Under bonnet and vehicle

The maintenance items listed here should be checked periodically (for example, each time you check the engine oil or refuel).

Battery (except for maintenance free batteries)*:

Check the fluid level in each cell. It should be between the <UPPER> and <LOWER> lines. Vehicles operated in high temperatures or under severe conditions require frequent checks of the battery fluid level.

Brake (and clutch) fluid level(s)*:

For Manual Transmission (MT) model: make sure that the brake and clutch fluid levels are between the <MAX> and <MIN> lines on the reservoirs.

Except for Manual Transmission (MT) model: make sure that the brake fluid level is between the <MAX> and <MIN> lines on the reservoir.

Engine coolant level*:

Check the coolant level when the engine is cold. Make sure that the coolant level is between the <MAX> and <MIN> lines on the reservoir.

Engine drive belt(s)*:

Make sure that drive belt(s) is/are not frayed, worn, cracked or oily.

Engine oil level*:

Check the level after parking the vehicle (on a level ground) and turning off the engine.

Fluid leaks:

Check under the vehicle for fuel, oil, water or other fluid leaks after the vehicle has been parked for a while. Water dripping from the air conditioner after use is normal. If you should notice any leaks or if fuel fumes are evident, check for cause and have it corrected immediately.

Power steering fluid level and lines*:

Check the level when the fluid is cold, with the engine off. Check the lines for proper attachment, leaks, cracks, etc.

Windscreen washer fluid*:

Check that there is adequate fluid in the reservoir.

MAINTENANCE PRECAUTIONS

When performing any inspection or maintenance work on your vehicle, always take care to prevent serious accidental injury to yourself or damage to the vehicle. The following are general precautions which should be closely observed.



WARNING

Park the vehicle on a level surface, apply the parking brake securely and block the wheels to prevent the vehicle from moving. Move the shift lever to the P (Park) position (AT model) or the shift lever to the N (Neutral) position (MT model).

Be sure the ignition switch is in the LOCK position when performing any parts replacement or repairs.

Do not work under the bonnet while the engine is hot. Always turn off the engine and wait until it cools down.

If you must work with the engine running, keep your hands, clothing, hair and tools away from moving fans, belts and any other moving parts.

It is advisable to secure or remove any loose clothing and any jewellery, such as rings, watches, etc. before working on your vehicle.

If you must run the engine in an enclosed space such as a garage, be sure there is proper ventilation for exhaust gasses to escape.

DO NOT GET UNDER A VEHICLE THAT IS SUPPORTED BY A JACK.

Keep smoking materials, flame and sparks away from fuel and the battery.

Never connect or disconnect either the battery or any transistorised component connector while the ignition switch is in the ON position.

Your vehicle is fitted with an automatic engine cooling fan. It may come on at any time without warning, even if the ignition switch is in the OFF position and the engine is not running. To avoid injury, always disconnect the negative battery cable before working near the fan.

Always wear eye protection whenever you work on your vehicle.

Never leave the engine or the transmission related component harness connector disconnected while the ignition switch is in the ON position.

Avoid direct contact with used engine oil and coolant. Improperly disposed engine oil, engine coolant, and/or other vehicle fluids can hurt the environment. Always conform to local regulations for disposal of vehicle fluids.

ENGINE COMPARTMENT CHECK LOCATIONS

This "8. Maintenance and do-it-yourself" section provides instructions regarding only those items which are relatively easy for an owner to perform.

You should be aware that incomplete or improper servicing may result in operating difficulties or excessive emissions, and could affect your warranty coverage. **If in doubt about any servicing, have it done by an approved dealer or qualified workshop.**

For an overview of the engine compartment, see "Engine compartment" in the "0. Illustrated table of contents" section.

ENGINE COOLING SYSTEM



WARNING

Never remove the radiator or coolant reservoir cap when the engine is hot. Serious burns could be caused by high-pressure fluid escaping from the radiator. Wait until the engine and radiator cool down.

Engine coolant is poisonous and should be stored carefully in marked containers out of the reach of children.

The engine cooling system is filled at the factory with a high-quality, year-round, anti-freeze coolant solution. The anti-freeze solution contains rust and corrosion inhibitors, therefore additional cooling system additives are not necessary.

CAUTION

Never use any cooling system additives such as radiator sealer. Additives may clog the cooling system and cause damage to the engine, transmission and/or cooling system.

When adding or replacing coolant, be sure to use the proper mixture ratio. Examples of the mixture ratio of coolant and water are shown in the following table:

Outside temperature down to		Engine coolant (concentrated)	Demineralised or distilled water
°C	°F		
-35	-30	50%	50%

The radiator is fitted with a pressure cap. To prevent engine damage, use only a Genuine RENAULT radiator cap or its equivalent when replacement is required.

CHECKING ENGINE COOLANT LEVEL

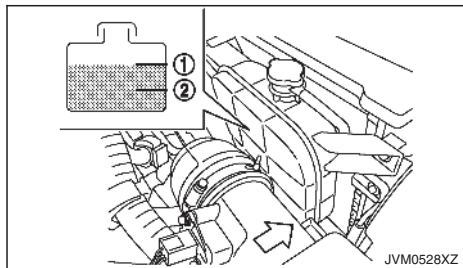

M9T 2.3DCI engine

Check the coolant level in the reservoir when the engine is cold. If the coolant level is below the <MIN> level ②, add coolant up to the <MAX> level ①. If the reservoir is empty, check the coolant level in the radiator **when the engine is cold**. If there is insufficient coolant in the radiator, fill the radiator with coolant up to the filler opening and also add it to the reservoir up to the <MAX> level ①. Tighten the cap securely after adding engine coolant.

If the cooling system frequently requires coolant, have it checked by an approved dealer or qualified workshop.

CHANGING ENGINE COOLANT

Contact an approved dealer or qualified workshop if replacement is required.

Major engine cooling system repair should be performed by an approved dealer or qualified workshop. The service procedures can be found in the appropriate Service Manual.

Improper servicing can result in reduced heater performance and engine overheating.



WARNING

To avoid being scalded, never change the coolant when the engine is hot.

Never remove the radiator or coolant reservoir cap when the engine is hot. Serious burns could be caused by high pressure fluid escaping from the radiator.

Avoid direct skin contact with used coolant. If skin contact is made, wash thoroughly with soap or hand cleaner as soon as possible.

Keep coolant out of reach of children and pets.

Engine coolant must be disposed of properly. Check your local regulations.

ENGINE OIL

CHECKING ENGINE OIL LEVEL

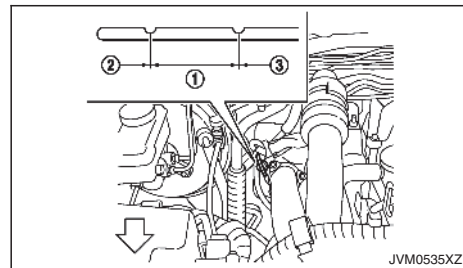

M9T 2.3DCI engine

1. Park the vehicle on a level surface and apply the parking brake.
 2. Start the engine and warm it up until the engine temperature reaches the normal operating temperature (approximately 5 minutes).
 3. Stop the engine.
 4. Wait at least 15 minutes for the engine oil to drain back to the oil pan.
 5. Remove the dipstick and wipe it clean.
 6. Reinsert the dipstick all the way.
 7. Remove the dipstick and check the oil level. It should be within the range ①.
 8. If the oil level is below ②, remove the oil filler cap and pour the recommended oil into the opening. Do not overfill ③.
- When filling the engine oil, do not remove the dipstick.

AdBlue® TANK (where fitted for diesel engine model)

9. Recheck the oil level with the dipstick.

CAUTION

The oil level should be checked regularly. Operating your vehicle with an insufficient amount of oil can damage the engine, and such damage is not covered by the warranty.

It is normal to add some oil between oil maintenance intervals or during the running-in period, depending on the severity of operating conditions.

CHANGING ENGINE OIL AND OIL FILTER

Contact an approved dealer or qualified workshop when the engine oil and oil filter require replacement.

PROTECT ENVIRONMENT

It is illegal to pollute drains, watercourses and soil. Use authorised waste collection facilities, including civil amenity sites and garages providing facilities for disposal of used oil and used oil filters. If in doubt, contact your local authority for advice on disposal.

The regulations concerning the pollution of the environment will vary from country to country.

REFILLING THE AdBlue® TANK

When the [Refill AdBlue] warning appears in the vehicle information display, refill the AdBlue® tank before the tank is empty (see "AdBlue® Selective Catalytic Reduction (SCR) system (where fitted for diesel engine model)" in the "5. Starting and driving" section for the AdBlue® warning display.) Refill the AdBlue® tank according to the procedures shown in this section.

CAUTION

Use only AdBlue®. Using other fluids will damage the AdBlue® Selective Catalytic Reduction (SCR) system.

Be careful not to spill AdBlue®. If the AdBlue® is spilled on the vehicle body, wipe it away with a wet cloth immediately to avoid paint damage.

AdBlue® residues crystallize after a period of time and contaminate the paint surfaces. If the spilled AdBlue® has crystallized, use a sponge and cold water to clean it.

Be careful not to inhale any ammonia vapours that may be released. Fill the AdBlue® tank in well-ventilated areas.

The AdBlue® tank is located underneath the vehicle. (see "AdBlue® filler lid and cap" in the "3. Pre-driving checks and adjustments" section for the AdBlue® filler lid location.)

1. Apply the parking brake.
2. Automatic Transmission (AT) model: Move the shift lever to the P (Park) position.
Manual Transmission (MT) model: Move the shift lever to the N (Neutral) position.

3. Place the ignition switch in the **OFF** position.
4. Open the AdBlue® filler lid.
5. Remove the AdBlue® tank cap by turning it anti-clockwise.
6. Refill the AdBlue® tank.
7. Securely install the AdBlue® tank cap.
8. Close the AdBlue® filler lid.
9. Place the ignition switch in the **ON** position and wait for approximately 1 minute until the [Refill AdBlue] warning turns off.

NOTE

In the case that the [ENG can't start Refill AdBlue] warning was displayed, check that the warning turned off, place the ignition switch in the OFF position once and then start the engine.

DRIVE BELT

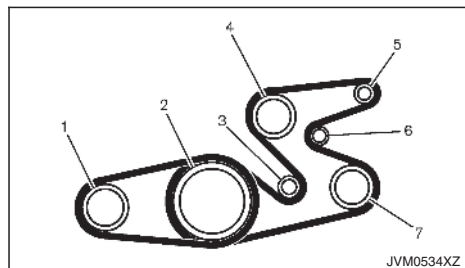

M9T 2.3DCI engine

1. Air conditioner compressor
2. Crankshaft pulley
3. Idler pulley
4. Water pump
5. Alternator
6. Automatic tensioner
7. Power steering fluid pump

Contact an approved dealer or qualified workshop if checking or replacement is required.

AUTOMATIC TRANSMISSION FLUID (ATF) (where fitted)

7-SPEED AUTOMATIC TRANSMISSION (AT) MODEL

Contact an approved dealer or qualified workshop if checking or replacement is required.

CAUTION

Use only ATF that is recommended in the Maintenance Service Booklet. Do not mix with other fluids.

Using automatic transmission fluid other than the ATF that is recommended in the Maintenance Service Booklet may cause deterioration in driveability and automatic transmission durability and may damage the automatic transmission. Such damage is not covered by the warranty.

POWER STEERING FLUID

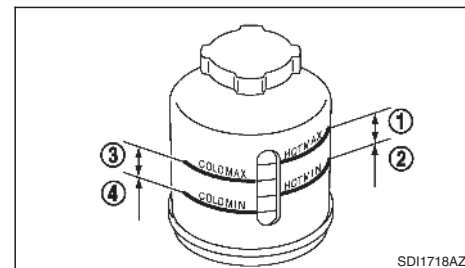

WARNING

Power steering fluid is poisonous and should be stored carefully in marked containers out of the reach of children.

Check the fluid level in the reservoir. The fluid level should be checked in the HOT range (①: HOT MAX., ②: HOT MIN.) at fluid temperatures of 50 to 80°C (122 to 176°F) or in the COLD range (③: COLD MAX., ④: COLD MIN.) at fluid temperatures of 0 to 30°C (32 to 86°F).

If it is necessary to add fluid, use only specified fluid. **Do not overfill.** (Refer to the maintenance service booklet for your vehicle for recommended types of fluid.)

BRAKES

CHECKING PARKING BRAKE

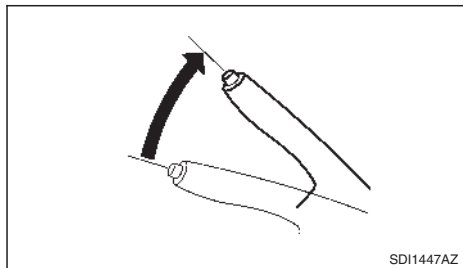

From the released position, pull the parking brake lever slowly and firmly. If the number of clicks is out of the range listed, see an approved dealer or qualified workshop.

7 to 9 clicks under a pulling force of 196 N (20 kg, 44 lb)

CHECKING FOOTBRAKE

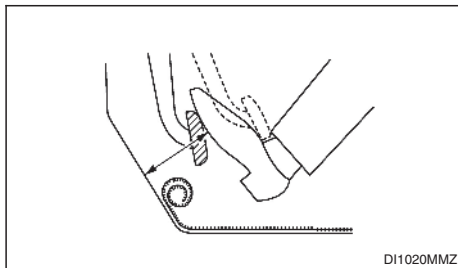

WARNING

See an approved dealer or qualified workshop for a brake system check if the brake pedal height does not return to normal.

With the engine running, check the distance between the upper surface of the pedal and the metal floor. If it is out of the range listed, see an approved dealer or qualified workshop.

**Depressing force
490 N (50 kg, 110 lb)**

	LHD model	RHD model
Diesel engine model	110 mm (4.3 in) or more	100 mm (3.9 in) or more

Brake pad wear warning

The disc brake pads have audible wear warnings. When a brake pad requires replacement, it will make a high pitched scraping sound when the vehicle is in motion. This scraping sound will first occur only when the brake pedal is depressed. After more wear

of the brake pad, the sound will always be heard even if the brake pedal is not depressed. Have the brakes checked as soon as possible if the wear warning sound is heard.

Under some driving or climate conditions, occasional brake squeaks, squeals or other noises may be heard. Occasional brake noise during light to moderate stops is normal and does not affect the function or performance of the brake system.

The rear drum brakes do not have audible wear indicators. Should you ever hear an unusually loud noise from the rear drum brakes, have them checked as soon as possible by an approved dealer or qualified workshop.

Proper brake inspection intervals should be followed. For additional information, see a separate maintenance booklet.

BRAKE BOOSTER

Check the brake booster function as follows:

1. With the engine off, depress and release the footbrake pedal several times. When the brake pedal movement (distance of travel) remains the same from one pedal application to the next, continue on to the next step.
2. While depressing the footbrake pedal, start the engine. The pedal height should drop a little.
3. With the footbrake pedal depressed, stop the engine. Keep the pedal depressed for about 30 seconds. The pedal height should not change.

BRAKE FLUID

4. Run the engine for 1 minute without depressing the footbrake pedal, then turn it off. Depress the footbrake pedal several times. The pedal travel distance will decrease gradually with each depression as the vacuum is released from the booster.

If the brakes do not operate properly, have the brakes checked by an approved dealer or qualified workshop.



WARNING

Use only new fluid from a sealed container. Old, inferior, or contaminated fluid may damage the brake system. The use of improper fluids can damage the brake system and affect the vehicle's stopping ability.

Clean the filler cap before removing.

Brake fluid is poisonous and should be stored carefully in marked containers out of the reach of children.

CAUTION

Refilling and checking the brake system should be left to an approved dealer or qualified workshop who will have the necessary brake fluid and technical knowledge.

Do not spill the fluid on painted surfaces. This will damage the paint. If fluid is spilled, wash with water.

For details of recommended fluids, refer to the maintenance service booklet for your vehicle.

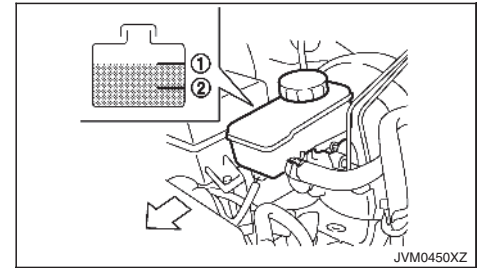

Check the fluid level in the reservoir. If the fluid is below the MIN line ②, the brake warning light will illuminate. Add fluid up to the MAX line ①.

If fluid must be added frequently, the system should be thoroughly checked by your approved dealer or qualified workshop.

CLUTCH FLUID (where fitted)



WARNING

Use only new fluid from a sealed container. Old, inferior, or contaminated fluid may damage the clutch system.

Clean the filler cap before removing.

Clutch fluid is poisonous and should be stored carefully in marked containers out of the reach of children.

CAUTION

Refilling and checking the clutch system should be left to an approved dealer or qualified workshop who will have the necessary clutch fluid and technical knowledge.

Do not spill the fluid on painted surfaces. This will damage the paint. If fluid is spilled, wash with water.

For details of recommended fluids, refer to the maintenance service booklet for your vehicle.

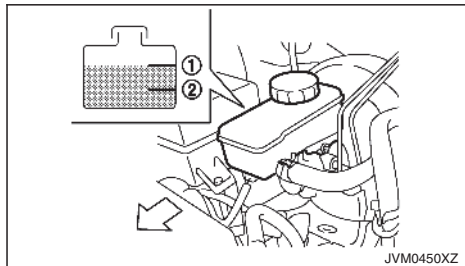

Check the fluid level in the reservoir. If the fluid is below the MIN line ②, add fluid up to the MAX line ①.

If the fluid must be added frequently, the clutch system should be thoroughly checked by an approved dealer or qualified workshop.

WINDOW WASHER FLUID

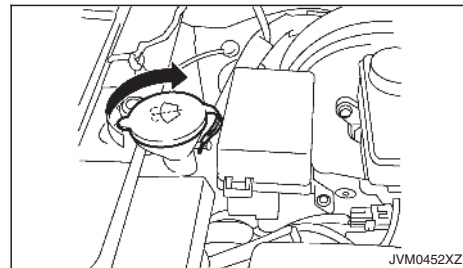

WARNING

Anti-freeze is poisonous and should be stored carefully in marked containers out of the reach of children.

Check the fluid level in the reservoir tank and add fluid if necessary.

If the low washer fluid warning (in the vehicle information display) or the low washer fluid warning light (in the meter) is equipped, the warning appears or the warning light illuminates when the reservoir tank fluid is at a low level. Add washer fluid as necessary.







Add a washer solvent to the water for better cleaning. In the winter season, add windscreen washer anti-freeze. Follow the manufacturer's instructions for the mixture ratio.

BATTERY

CAUTION

Do not substitute anti-freeze engine coolant for window washer solution. This may result in damage to the paint.

Always use window washer fluid recommended by an approved dealer or qualified workshop.

Caution symbols for battery			 WARNING
①		No smoking No exposed flames No sparks	Never smoke around the battery. Never expose the battery to open flames or electrical sparks.
②		Shield eyes	Handle the battery cautiously. Always wear eye protection glasses to protect against explosion or battery acid.
③		Keep away from children	Never allow children to handle the battery. Keep the battery out of reach of children.
④		Battery acid	Do not allow battery fluid to contact your skin, eyes, fabrics, or painted surfaces. After handling the battery or battery cap, immediately wash your hands thoroughly. If the battery fluid gets into your eyes, or onto your skin or clothing, flush with water immediately for at least 15 minutes and seek medical attention. Battery fluid is acid. If the battery fluid gets into your eyes or onto your skin, it could cause eyesight loss or burns.
⑤		Note operating instructions	Before handling the battery, read this instruction carefully to ensure correct and safe handling.
⑥		Explosive gas	Hydrogen gas, generated by battery fluid, is explosive.

VEHICLE BATTERY



WARNING

Do not operate the vehicle if the fluid in the battery is low. Low battery fluid can cause a higher load on the battery which can generate heat, reduce battery life, and in some cases lead to an explosion.

Checking battery fluid level

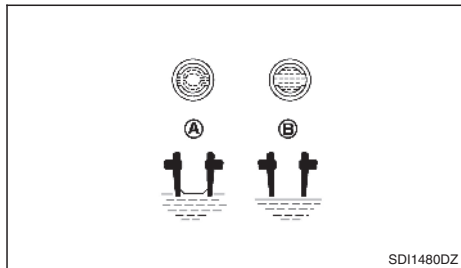
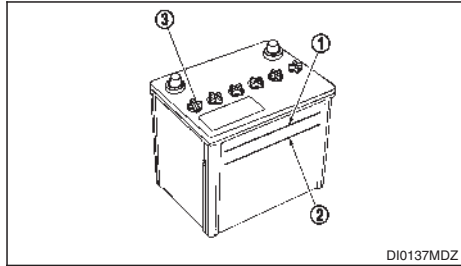

Check the fluid level in each cell. The battery fluid level should be between the UPPER LEVEL ① and LOWER LEVEL ② lines.

If it is necessary to add fluid, add only demineralised/distilled water to bring the level to the indicator in each filler opening. Do not overfill.

1. Remove the cell plugs ③ using a suitable tool.
2. Add demineralised/distilled water up to the UPPER LEVEL ① line.

If the side of the battery is not clear, check the distilled water level by looking directly above the cell; the condition (A) indicates OK and the condition (B) needs more to be added.

3. Replace and tighten the cell plugs.

Vehicles operated in high temperatures or under severe conditions require frequent checks of the battery fluid level.

Keep the battery surface clean and dry. Any corrosion should be cleared with a firmly wrung out moist cloth.

Make certain the terminal connections are clean and securely tightened.

If the vehicle is not to be used for more than 30 days, disconnect the negative (-) battery terminal cable to prevent battery discharge.

Jump starting

If jump starting is necessary, see "Jump starting" in the "6. In case of emergency" section. If the engine does not start by jump starting or the battery does not charge, the battery may have to be replaced. Contact an approved dealer or qualified workshop for replacing the battery.

REMOTE CONTROLLER BATTERY (where fitted)

Remote controller battery replacement

CAUTION

Be careful not to allow children to swallow the battery and removed parts.

An improperly disposed battery can harm the environment. Always confirm local regulations for battery disposal.

When changing batteries, do not let dust or oil get on the components.

There is danger of explosion if lithium battery is incorrectly replaced. Replace only with the same or equivalent type.

Do not expose the battery to excessive heat such as sunshine, fire, etc.

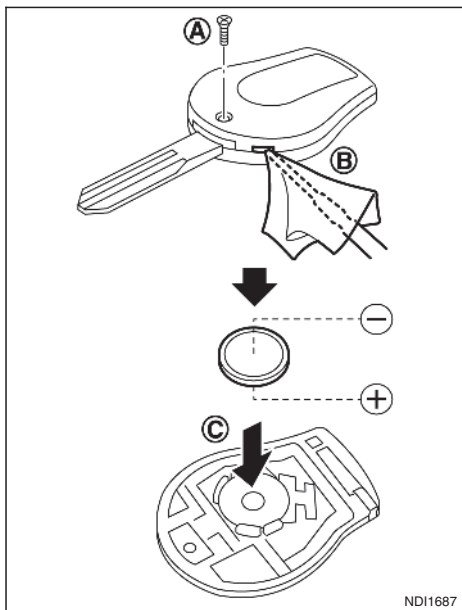

NDI1687

To replace the battery:

1. Use an appropriate tool to remove the screw (A) and open the lid (B).
2. Replace the battery with a new one.

Recommended battery: CR1620 or equivalent

Do not touch the internal circuit and electric terminals as doing so could cause a malfunction.

Make sure that the + side faces the bottom of the case (C).

3. Close the lid and install the screw securely.
4. Operate the buttons to check its operation.

See an approved dealer or qualified workshop if you need assistance for replacement.

REMOTE CONTROL KEY BATTERY (where fitted)

Remote Control Key battery replacement

CAUTION

Be careful not to allow children to swallow the battery and removed parts.

An improperly disposed battery can harm the environment. Always confirm local regulations for battery disposal.

When changing batteries, do not let dust or oil get on the components.

There is danger of explosion if lithium battery is incorrectly replaced. Replace only with the same or equivalent type.

Do not expose the battery to excessive heat such as sunshine, fire, etc.

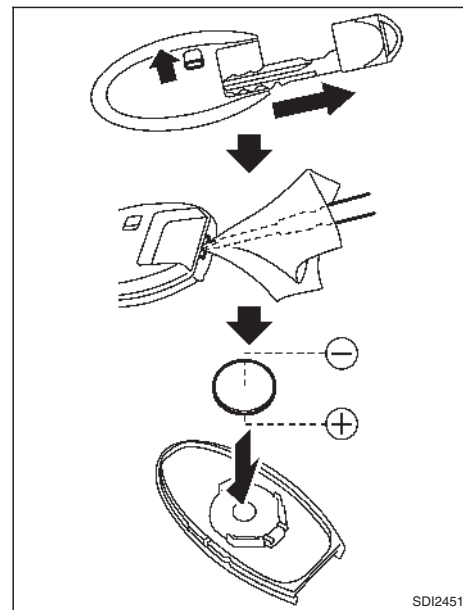

SDI2451

To replace the battery:

1. Release the lock knob at the back of the Remote Control Key and remove the mechanical key.
2. Insert a small screwdriver into the slit of the corner and twist it to separate the upper part from the lower part. Use a cloth to protect the casing.
3. Replace the battery with a new one.

AIR CLEANER FILTER

Recommended battery: CR2025 or equivalent

Do not touch the internal circuit and electric terminals as doing so could cause a malfunction.

Make sure that the ⊕ side faces the bottom of the case.

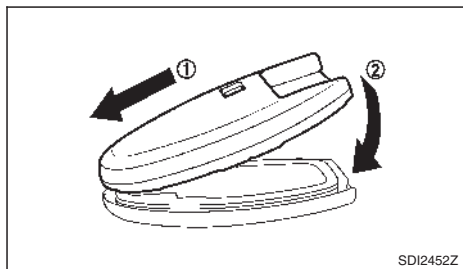

4. Align the tips of the upper and lower parts ①, and then push them together until it is securely closed ②.

5. Operate the buttons to check its operation.

See an approved dealer or qualified workshop if you need assistance for replacement.

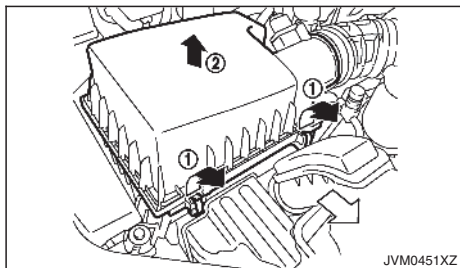

WARNING

Operating the engine with the air cleaner filter off can cause you or others to be burned. The air cleaner filter not only cleans the intake air, it also stops flame if the engine backfires. If the air cleaner filter is not installed and the engine backfires, you could be burned. Never drive with the air cleaner filter off. Be cautious working on the engine when the air cleaner filter is off.

Never pour fuel into the throttle body or attempt to start the engine with the air cleaner removed. Doing so could result in serious injury.

To remove the filter, release the lock pins ① and pull the unit upward ②.

The dry paper type filter element may be cleaned and reused. Replace the air filter according to the maintenance schedule shown in a separate maintenance booklet.

When replacing the filter, wipe the inside of the air cleaner housing and the cover with a damp cloth.

WIPER BLADES

WINDSCREEN WIPER BLADES

Cleaning

If the windscreen does not become clear after using the windscreen washer or if the wiper blades chatter when operating the windscreen wipers, wax or other materials may be on the windscreen and/or wiper blades.

Clean the outside of the windscreen surface with a washer solution or mild detergent. Your windscreen is clean if beads do not form when rinsing with water.

Clean the blade by wiping it with a cloth soaked in a washer solution or a mild detergent. Rinse the blade with water. If your windscreen is still not clear after cleaning the blades and using the wipers, replace the blades.

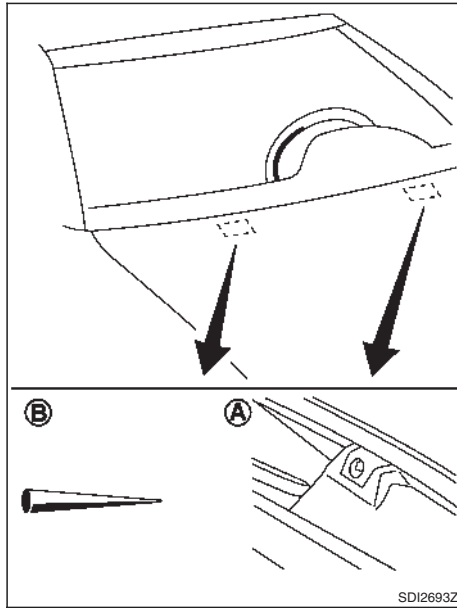

Be careful not to clog the washer nozzle (A). This may cause improper windscreen washer operation. If the nozzle is clogged, remove any objects with a needle or small pin (B). Be careful not to damage the nozzle.

VARIABLE VOLTAGE CONTROL SYSTEM (where fitted)

The variable voltage control system measures the amount of electrical discharge from the battery and controls voltage generated by the alternator.

CAUTION

Do not ground accessories directly to the battery terminal. Doing so will bypass the variable voltage control system and the vehicle battery may not charge completely.

Use electrical accessories with the engine running to avoid discharging the vehicle battery.

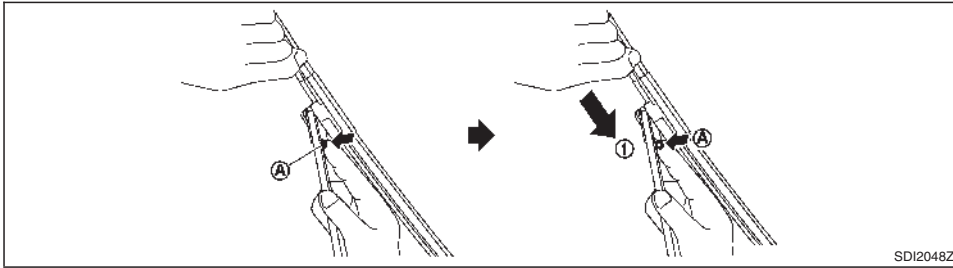

Replacing

Replace the wiper blades if they are worn.

1. Pull the wiper arm.
2. Push and hold the release tab (A), and then move the wiper blade down ① the wiper arm to remove.
3. Remove the wiper blade.
4. Insert the new wiper blade onto the wiper arm until it clicks into place.

CAUTION

After wiper blade replacement, return the wiper arm to its original position. Otherwise the wiper arm or the engine bonnet may be scratched and may cause damage.

Worn windscreen wiper blades can damage the windscreen and impair driver vision.

FUSES

ENGINE COMPARTMENT

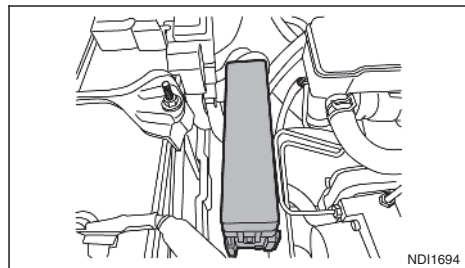
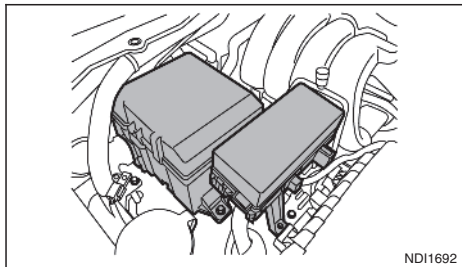

The location and the amperage rating of fuses are shown on the underside of the fuse box lid.

The number of fuses may vary depending on the features equipped to the vehicle.

If any electrical equipment does not operate, check for an open fuse.

1. Be sure the ignition switch is in the OFF or LOCK position.
2. Be sure the headlight switch is in the OFF position.
3. Open the engine bonnet.
4. Remove the fuse/fusible link cover by pushing the tab.
5. Locate the fuse which needs to be replaced.

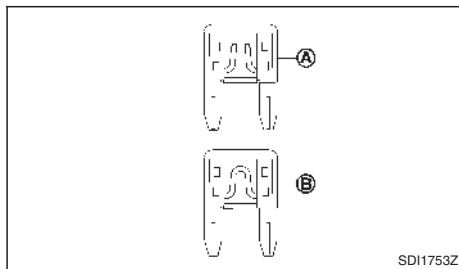

6. Remove the fuse using the fuse puller located in the passenger compartment fuse box.
7. If the fuse is open (A), replace it with a new fuse (B).

If the new fuse also opens, after installing, have the electrical system checked, and if necessary repaired, by an approved dealer or qualified workshop.

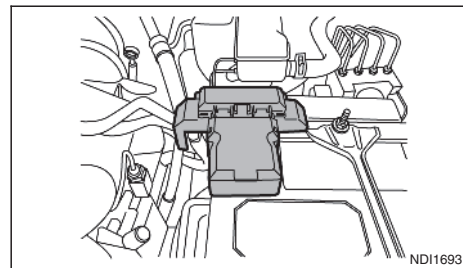

Fusible links

If any electrical equipment does not operate and the fuses are in good condition, check the fusible links. If any of these fusible links are melted, replace only with genuine replacement parts.

CAUTION

Never use a fuse of a higher or lower amperage rating than that specified on the fuse box cover. This could damage the electrical system or cause a fire.

Never attempt to use other material (wire, aluminium foil, etc.) in place of a fuse. This could damage the electrical system or cause a fire.

PASSENGER COMPARTMENT

Main fuse box

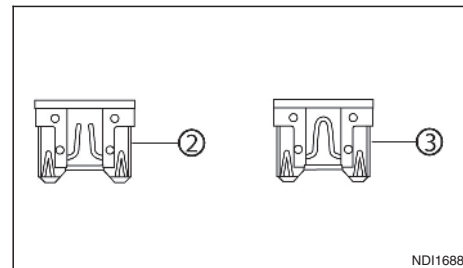
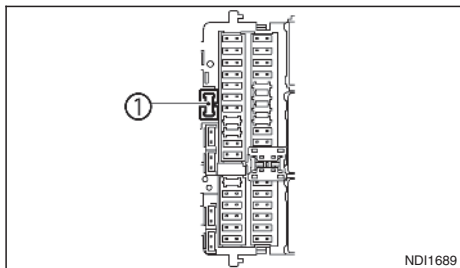
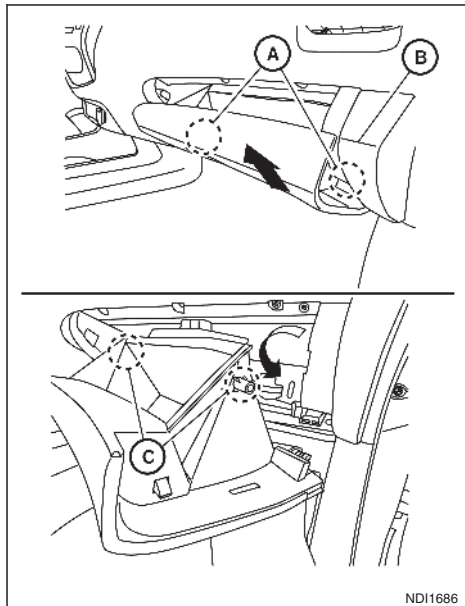

1. Be sure the ignition switch is in the OFF position.
2. Be sure the headlight switch is in the OFF position.
3. Open the glove box.
4. Hold the glove box lid and pull it up to release the hinges **A** located on the underside of the glove box. As a reference, align the glove box lid with corner **B**.
5. Carefully release the left and right stoppers **C** and remove the glove box.
6. Locate the fuse that needs to be replaced.
7. Remove the fuse using the fuse puller **1**.

8. If the fuse is open **2**, replace it with a new fuse **3**.
9. Install the glove box following removal steps in opposite sequence.

If the new fuse also opens, after installing, have the electrical system checked, and if necessary repaired, by an approved dealer or qualified workshop.

Additional fuse box

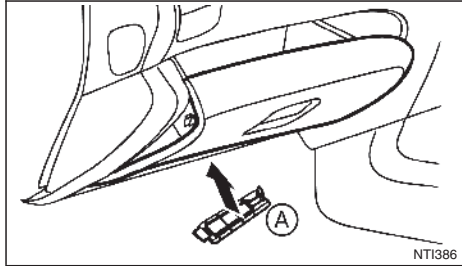

1. Be sure the ignition switch is in the OFF position.
2. Be sure the headlight switch is in the OFF position.
3. Remove the fuse box cover (A) from beneath the glove box.
4. Locate the fuse that needs to be replaced.
5. Remove the fuse using the fuse puller located in the main fuse box.
6. If the fuse is open, replace it with a new fuse.
7. Install the fuse box cover.

If the new fuse also opens, after installing, have the electrical system checked, and if necessary repaired, by an approved dealer or qualified workshop.

Extended storage fuse switch (where fitted)

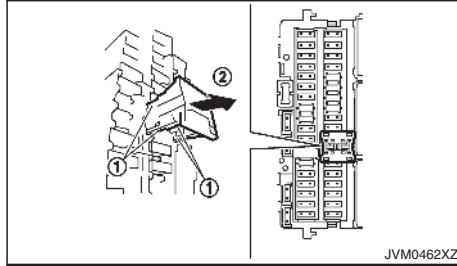

To reduce battery drain, the extended storage fuse switch comes from the factory switched off. Prior to delivery of your vehicle, the switch is pushed in (switched on) and should always remain on.

If the extended storage fuse switch is not pushed in (switched on), the [Shipping Mode On Push Storage Fuse] warning may appear in the vehicle information display. See "Indicators for operation" in the "2. Instruments and controls" section.

If any electrical equipment does not operate, remove the extended storage fuse switch and check for an open fuse.

NOTE

If the extended storage fuse switch malfunctions or if the fuse is open, it is not necessary to replace the switch. In this case, remove the extended storage fuse switch and replace it with a new fuse of the same rating.

How to remove the extended storage fuse switch:

1. To remove the extended storage fuse switch, be sure the ignition switch is in the OFF or LOCK position.
2. Be sure the headlight switch is in the OFF position.
3. Remove the fuse box cover.
4. Pinch the locking tabs (1) found on each side of the storage fuse switch.
5. Pull the extended storage fuse switch straight out from the fuse box (2).

LIGHTS

HEADLIGHTS

Fog may temporarily form inside the lens of the exterior lights in the rain or in a car wash. A temperature difference between the inside and the outside of the lens causes the fog. This is not a malfunction. If large drops of water collect inside the lens, contact an approved dealer or qualified workshop.

Replacing LED headlight

If replacement is required, contact an approved dealer or qualified workshop.

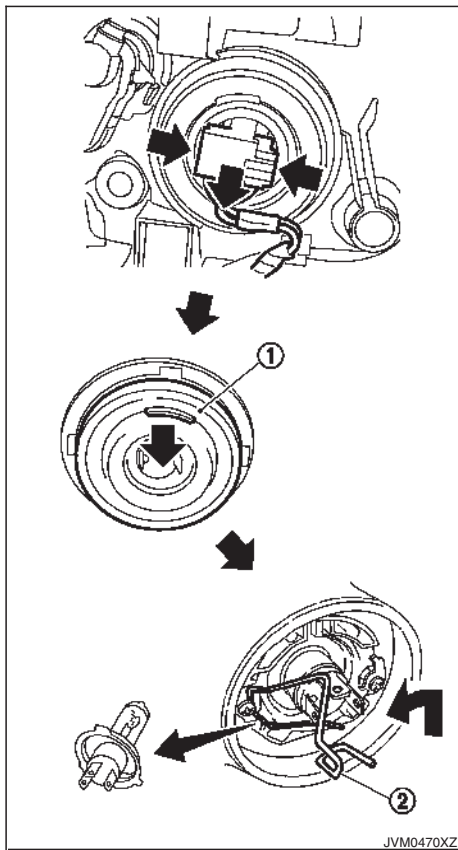

Replacing halogen headlight bulb

The halogen headlight is a semi-sealed beam type which uses replaceable headlight (halogen) bulbs. They can be replaced from inside the engine compartment without removing the headlight assembly.

CAUTION

High-pressure halogen gas is sealed inside the bulb. The bulb may break if the glass envelope is scratched or the bulb is dropped.

1. Disconnect the battery negative cable.
2. Disconnect the electrical connector from the rear end of the bulb.
3. Pull off the rubber cap ①.
4. Push and turn the retaining pin ② to loosen it.
5. Remove the headlight bulb. Do not shake or rotate the bulb when removing it.
6. Install the new bulb in the reverse order of removal.

CAUTION

When handling the bulb, do not touch the glass envelope.

Use the same number and wattage as originally installed:

Halogen headlight model

High/low beam bulb: 60W/55W (H4)

Do not leave the bulb out of the headlight reflector for a long period of time as dust, moisture and smoke may enter the headlight body and affect the performance of the headlight.

Aiming adjustment is not necessary if only the bulbs are replaced. When aiming adjustment is necessary, contact an approved dealer or qualified workshop.

EXTERIOR LIGHTS

Item	Wattage (W)
Front turn signal	21
Clearance light (Halogen headlight models)	5
Clearance light and daytime running light (LED headlight models)*	LED
Front fog light (where fitted)	55
Daytime running light (where fitted for halogen headlight models)	19
Side turn signal light (on the front wing) (where fitted)	5
Rear combination light	
Turn signal	21
Stop/tail	21/5
Reverse	21
Number plate light	5
High-mounted stop light (where fitted)*	LED

*: See an approved dealer or qualified workshop for replacement.

INTERIOR LIGHTS

Item	Wattage (W)
Map light (LED type)*	LED
Map light (bulb type)	5
Room light (where fitted)	8
Rear personal light (where fitted)	LED
Step light (where fitted)	3.4
Vanity mirror light (where fitted)	1.8

*: See an approved dealer or qualified workshop for replacement.

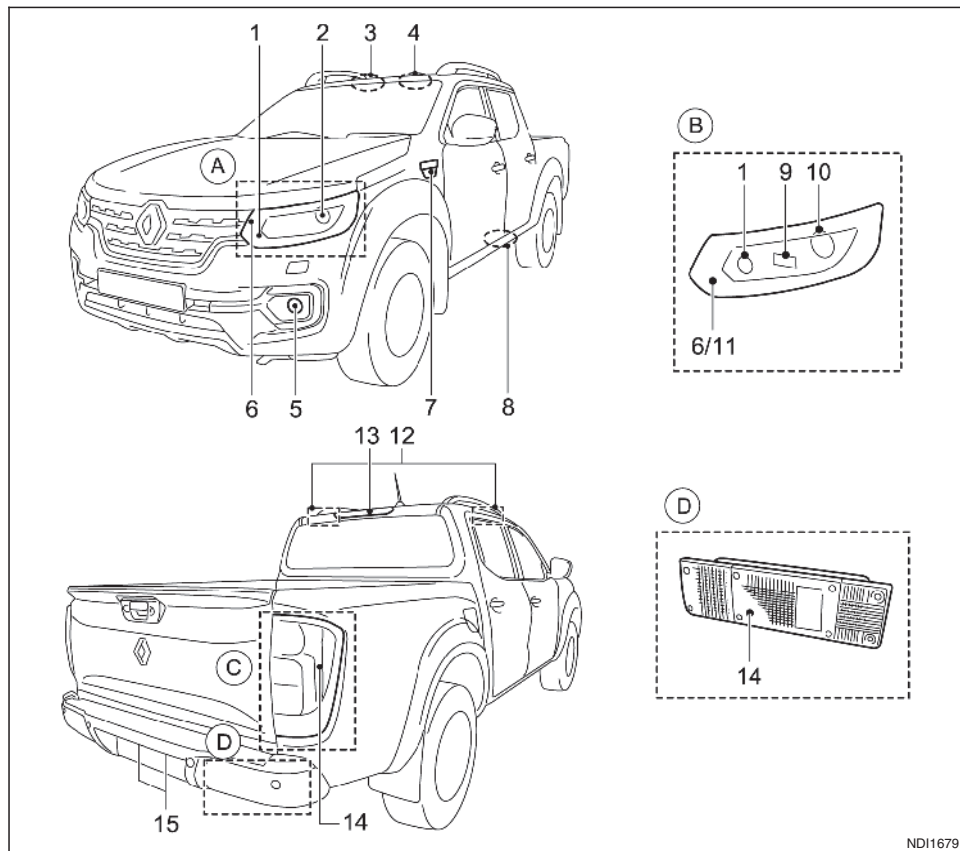

LIGHT LOCATIONS

1. Front turn signal light
 2. Headlight (halogen type)
 3. Map light
 4. Room light (where fitted)
 5. Front fog light (where fitted) or Daytime running light (where fitted for halogen headlight model)
 6. Clearance light
 7. Side turn signal light (where fitted)
 8. Step light (where fitted)
 9. Headlight (high beam) (LED type)
 10. Headlight (low beam) (LED type)
 11. Daytime running light (LED type)
 12. Rear personal light (where fitted)
 13. High-mounted stop light (where fitted)
 14. Rear combination light (Turn signal/Stop/Tail/Reverse)
 15. Number plate light
- Ⓐ: Halogen headlight model
 Ⓑ: LED headlight model
 Ⓒ: Models with cargo bed
 Ⓓ: Models without cargo bed

ND11679

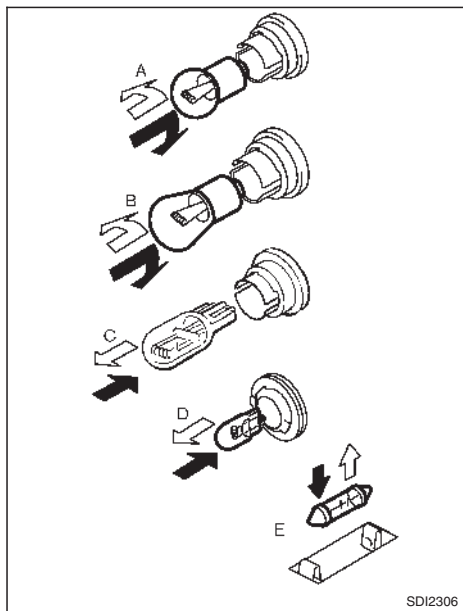

Replacement procedures

All other lights are either type A, B, C, D or E. When replacing a bulb, first remove the lens and/or cover.

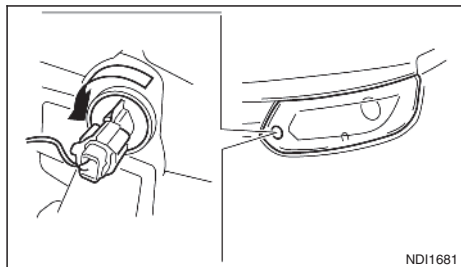

Front turn signal light

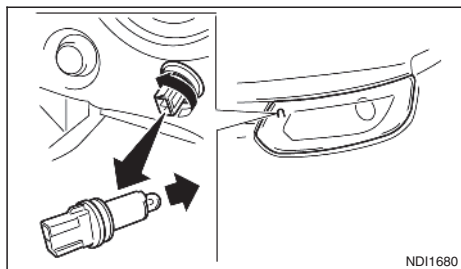

Clearance light (bulb type)

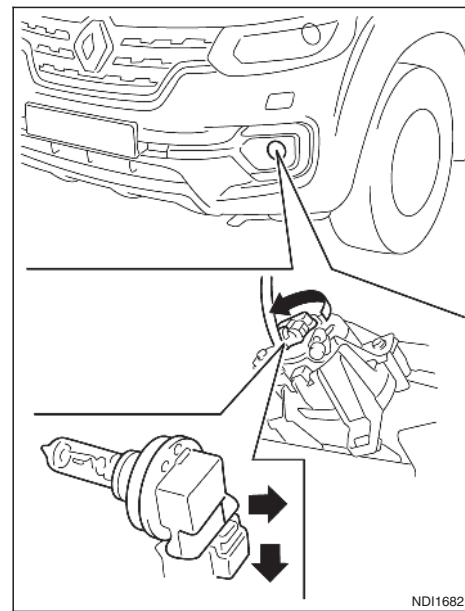

Front fog light (where fitted) or daytime running light (where fitted)



REMOVE



INSTALL

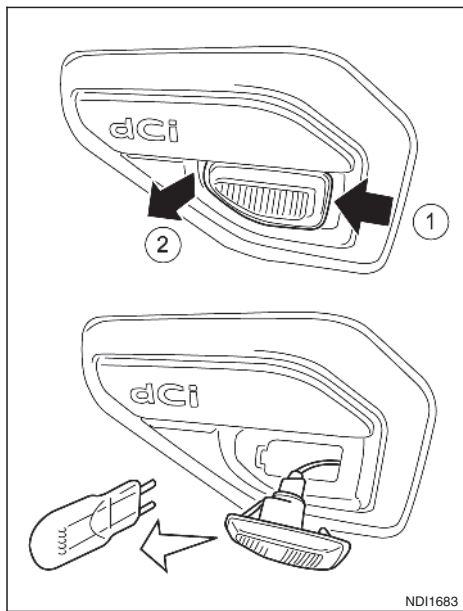

Side turn signal light (on the front wing) (where fitted)

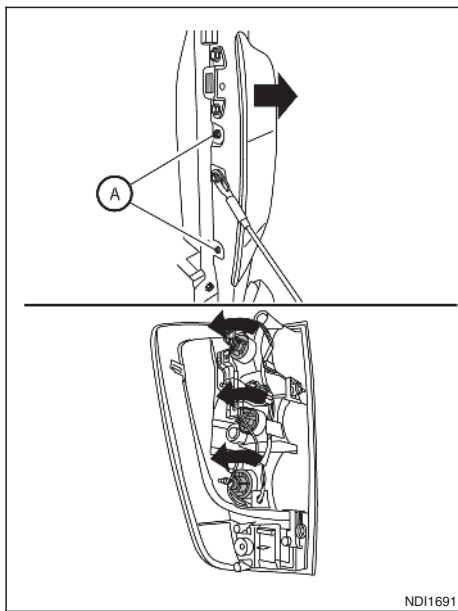

Rear combination light (turn signal, stop and reverse)
(models with cargo bed)

1. Remove two screws (A) and remove rear combination light from vehicle.
2. Rotate bulb socket and remove from rear combination light.
3. Replace the necessary bulbs.

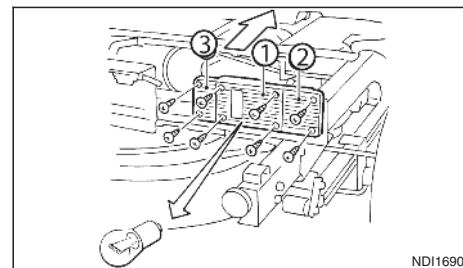

Rear combination light (turn signal, stop and reverse)
(models without cargo bed)

- ①: Stop/tail light
- ②: Turn signal light
- ③: Reverse light

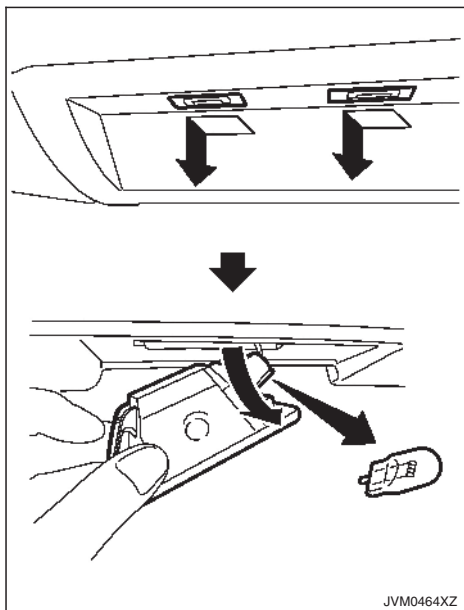

Number plate light

JVM0464XZ

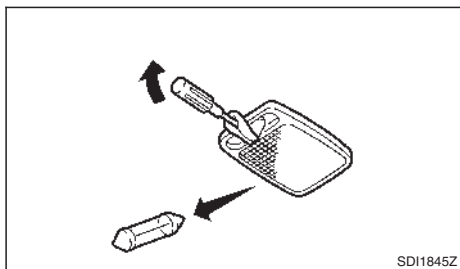

Room light (where fitted)

SDI1845Z

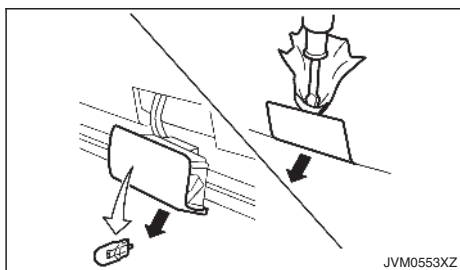

Step light (where fitted)

JVM0553XZ

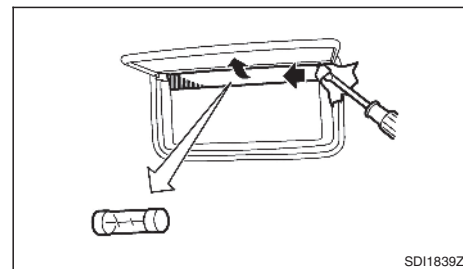

Vanity mirror light (where fitted)

SDI1839Z

TYRES AND WHEELS

If you have a flat tyre, see “Flat tyre” in the “6. In case of emergency” section.

TYRE INFLATION PRESSURE

Periodically check the pressure of the tyres, including the spare. An incorrect tyre pressure may adversely affect tyre life and vehicle handling. The tyre pressure should be checked when tyres are COLD. Tyres are considered COLD after the vehicle has been parked for 3 or more hours, or driven less than 1.6 km (1 mile). COLD tyre pressures are shown on the tyre placard.

Insufficient pressure can lead to an overheating of the tyre and subsequent internal damage. At high speeds, this could result in tread separation and even bursting of the tyre.

TYPES OF TYRES

CAUTION

When changing or replacing tyres, be sure all four tyres are of the same type (that is, summer, all season or snow) and construction. An approved dealer or qualified workshop may be able to help you with information about tyre type, size, speed rating and availability.

Replacement tyres may have a lower speed rating than the factory equipped tyres, and they may not match the potential maximum vehicle speed. Never exceed the maximum speed rating of the tyre.

All season tyres

RENAULT specifies all season tyres on some models to provide good performance all year, including snowy and icy road conditions. All season tyres are identified by ALL SEASON and/or M&S on the tyre sidewall. Snow tyres have better snow traction than all season tyres and may be more appropriate in some areas.

Summer tyres

RENAULT specifies summer tyres on some models to provide superior performance on dry roads. Summer tyre performance is substantially reduced in snow and ice. Summer tyres do not have the tyre traction rating M&S on the tyre sidewall.

If you plan to operate your vehicle in snowy or icy conditions, RENAULT recommends the use of snow or all season tyres on all four wheels.

Snow tyres

If snow tyres are needed, it is necessary to select tyres equivalent in size and load rating to the original equipment tyres. If you do not, it can adversely affect the safety and handling of your vehicle.

Generally, snow tyres have lower speed ratings than factory equipped tyres and may not match the potential maximum vehicle speed. Never exceed the maximum speed rating of the tyre. If you install snow tyres, they must be the same size, brand, construction and tread pattern on all four wheels.

For additional traction on icy roads, studded tyres may be used. However, some states and provinces prohibit their use. Check local, state and provincial laws before installing studded tyres. Skid and trac-

tion capabilities of studded snow tyres on wet or dry surfaces may be poorer than that of non-studded snow tyres.

Four-Wheel Drive (4WD) model

CAUTION

Always use tyres of the same type, size, brand, construction (bias, bias-belted or radial), and tread pattern on all four wheels. Failure to do so may result in a circumference difference between tyres on the front and rear axles which will cause excessive tyre wear and may damage the transmission, transfer case and differential gears.

ONLY use spare tyres specified for the 4WD model.

If excessive tyre wear is found, it is recommended that all four tyres be replaced with tyres of the same size, brand, construction and tread pattern. The tyre pressure and wheel alignment should also be checked and corrected as necessary. Contact an approved dealer or qualified workshop.

TYRE CHAINS

Use of tyre chains may be prohibited according to location. Check the local laws before installing tyre chains. When installing tyre chains, make sure that they are of proper size for the tyres on your vehicle and are installed according to the chain manufacturer's instructions.

Use chain tensioners when recommended by the tyre chain manufacturer to ensure a tight fit. Loose end links of the tyre chains must be secured or removed to prevent the possibility of whipping action damage to the wings or underbody. If possible,

avoid fully loading your vehicle when using tyre chains. In addition, drive at a reduced speed. Otherwise, your vehicle may be damaged and/or vehicle handling and performance may be adversely affected.

Tyre chains must be installed only on the rear wheels and not on the front wheels.

Do not drive with tyre chains on paved roads which are clear of snow. Driving with chains in such conditions can cause damage to the various mechanisms of the vehicle due to some overstress.

TYRE ROTATION

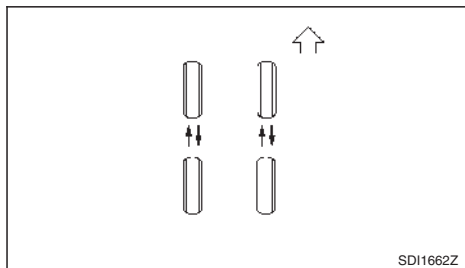

RENAULT recommends that tyres be rotated every 5,000 km (3,000 miles) for Four-Wheel Drive (4WD) or every 10,000 km (6,000 miles) for Two-Wheel Drive (2WD) model. However, the timing for tyre rotation may vary according to your driving habits and the road surface conditions. (See “Flat tyre” in the “6. In case of emergency” section for the tyre replacement.)



WARNING

After rotating the tyres, adjust the tyre pressure.

Retighten the wheel nuts when the vehicle has been driven for 1,000 km (600 miles) (also in cases of a flat tyre, etc.).

Do not include the spare tyre in tyre rotation.

Incorrect tyre selection, fitting, care or maintenance can affect vehicle safety with risk of accident and injury. If in doubt, consult an approved dealer or qualified workshop or the tyre manufacturer.

TYRE WEAR AND DAMAGE

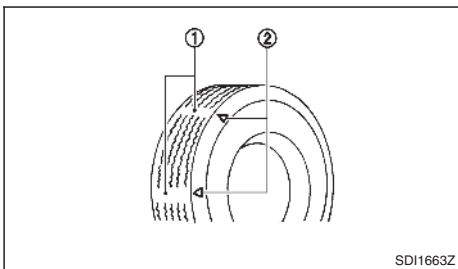

- ① : Wear indicator
- ② : Wear indicator location mark

Tyres should be periodically inspected for wear, cracking, bulging or objects caught in the tread. If excessive wear, cracks, bulging or deep cuts are found, the tyre should be replaced immediately.

The original tyres have a built-in tread wear indicator. When the wear indicator is visible, the tyre should be replaced.

Improper service of a spare tyre may result in serious personal injury. If it is necessary to repair the spare tyre, contact an approved dealer or qualified workshop.

TYRE AGE

Never use a tyre over six years old, regardless of whether it has been used or not.

Tyres degrade with age as well as with the vehicle usage. Have your tyres checked and balanced often by a repair shop or, if you prefer, an approved dealer or qualified workshop.

CHANGING TYRES AND WHEELS



WARNING

Do not install a deformed wheel or tyre even if it has been repaired. Such wheels or tyres could have structural damage and could fail without warning.

When replacing a tyre, use the same size, speed rating and load carrying capacity as originally equipped. (See “Tyres and wheels” in the “9. Technical information” section for recommended types and sizes of tyres and wheels.) The use of tyres other than those recommended or the mixed use of tyres of different brands, construction (bias, bias-belted, or radial), or tread patterns can adversely affect the ride, braking, handling, ground clearance, body-to-tyre clearance, snow chain clearance, speedometer

calibration, headlight aim and bumper height. Some of these effects may lead to accidents and could result in serious personal injury.

If the wheels are changed for any reason, always replace with wheels which have the same offset dimension. Wheels of a different offset could cause early tyre wear, possibly degraded vehicle handling characteristics and/or interference with the brake discs/drums. Such interference can lead to decreased braking efficiency and/or early brake pad/shoe wear.

WHEEL BALANCE

Unbalanced wheels may affect vehicle handling and tyre life. Even with regular use, wheels can get out of balance. Therefore, they should be balanced as required.

SPARE TYRE

Conventional spare tyre (where fitted)

A standard tyre (the same size as the road wheels) is supplied with your vehicle.

Temporary spare tyre (where fitted)

The temporary spare tyre is a different size from the road wheels.

Temporary spare tyres can be distinguished as follows:

- Tyre and wheel size differs from the four mounted tyres and wheels.
- There is a label in the wheel with a speed limitation.

In order to avoid malfunction adhere to the following:

Never drive at speeds above 80 km/h (50 MPH).

Drive with special caution when a temporary spare wheel is mounted.

Never mount more than 1 temporary spare tyre at a time to the same vehicle.

For tyre inflation pressure, apply same pressure as specified for the axle the tyre is mounted on, unless there is another indication on the tyre placard. See, "Tyre placard" in the "9. Technical information" section.

Disable ESP when a temporary spare wheel is mounted. See, "Electronic Stability Programme (ESP) system (where fitted)" in the "5. Starting and driving" section.

Never tow a trailer when a temporary use only spare tyre is mounted.

NOTE

9 Technical information

Recommended fluids/lubricants and capacities	9-2	Vehicle identification.....	9-7
Fuel information.....	9-2	Vehicle identification label.....	9-7
Automatic Transmission Fluid (ATF).....	9-2	Vehicle Identification Number (VIN) plate.....	9-7
Air conditioner system refrigerant and lubricant.....	9-2	Vehicle Identification Number (VIN).....	9-7
Engine.....	9-3	Engine serial number.....	9-7
Tyres and wheels	9-4	Tyre placard	9-8
Dimensions.....	9-5	Air conditioner specification label	9-8
Double Cab.....	9-5	Installation of an RF transmitter	9-8
King Cab	9-6	Radio approval number and information	9-9
When travelling or registering in another country.....	9-7	Radio frequency approval.....	9-9

RECOMMENDED FLUIDS/ LUBRICANTS AND CAPACITIES

Refer to the maintenance service booklet for your vehicle for details of recommended fluids/lubricants and capacities.

FUEL INFORMATION

Diesel engine*

Compatible Fuels for Diesel Engine	
The diesel engine is compatible with current and future European standards for bio-fuel.	
	Diesel conforming to EN16734 and mixed with a bio-fuel conforming to EN14214 (incorporating between 0 and 10% Fatty Acid Methyl Esters).

M9T 2.3DCI engine:

Diesel fuel above 50 cetane and with less than 10 ppm of sulphur (EN590) must be used.

* If two types of diesel fuel are available, use summer or winter fuel properly according to the following temperature conditions.

Above -7°C (20°F) ... Summer type diesel fuel.

Below -7°C (20°F) ... Winter type diesel fuel.

CAUTION

Do not use home heating oil, petrol or other alternate fuels in your diesel engine. The use of those or adding those to diesel fuel can cause engine damage.

Do not use summer fuel at temperatures below -7°C (20°F). The cold temperatures will cause wax to form in the fuel. As a result, it may prevent the engine from running smoothly.

AUTOMATIC TRANSMISSION FLUID (ATF)

Contact an approved dealer or qualified workshop if checking or replacement is required.

CAUTION

Use only ATF that is recommended in the Maintenance Service Booklet. Do not mix with other fluids.

Using automatic transmission fluid other than the ATF that is recommended in the Maintenance Service Booklet may cause deterioration in driveability and automatic transmission durability and may damage the automatic transmission. Such damage is not covered by the warranty.

AIR CONDITIONER SYSTEM REFRIGERANT AND LUBRICANT

The air conditioner system of your vehicle must be charged with the refrigerant HFC-134a (R134a) and the lubricant specified in the maintenance service booklet for your vehicle.

CAUTION

Use of any other refrigerants or lubricants will cause severe damage, and you may need to replace your vehicle's entire air conditioner system.

The release of refrigerants into the atmosphere is prohibited in many countries and regions. The refrigerant HFC-134a (R-134a) in your vehicle will not harm the Earth's ozone layer. However, it may contribute in a small part to the global warming effect. RENAULT recommends that the refrigerant be ap-

propriately recovered and recycled. Contact an approved dealer or qualified workshop when servicing the air conditioner system.

ENGINE

Engine Model		M9T 2.3DCI
Type		Diesel, 4-cycle
Cylinder arrangement		4-cylinder, in-line
Bore x Stroke	mm (in)	85 x 101.3 (3.346 x 3.988)
Displacement	cm ³ (cu in)	2,298 (140.22)
Idle speed at the "N" (Neutral) position	rpm	750±50
Camshaft operation		Timing chain

TYRES AND WHEELS

Tyre	Conventional	Size	205R16C 110/108 S	255/70R16 111 T/108/104 S	255/60R18 112 T	
	Spare	Size	Conventional	Conventional	Conventional	255/70R16
Road wheel	Conventional	Size	16 × 6J	16 × 7J	18 × 7J	
		Offset mm (in)	55 (2.17)	45 (1.77)	45 (1.77)	
	Spare	Size	Conventional		Conventional	16 × 7J
		Offset	Conventional		Conventional	45 (1.77)

See the tyre placard on your vehicle for the recommended COLD tyre pressure.

DIMENSIONS

DOUBLE CAB

mm (in)

Body type		Double Cab
Overall length	Models without bed and rear bumper	5,120 (201.6)
	Models with bed and without rear bumper	5,300 (208.6)
	Models with bed and rear bumper	5,330 (209.8)
Overall width	Wide body models	1,850 (72.8)
Overall height	Four-Wheel Drive (4WD) models	1,805 (71.1)*2*3*4
		1,810 (71.3)*2*4
		1,840 (72.4)*1
Front tread		1,570 (61.8)
Rear tread		1,570 (61.8)
Wheelbase		3,150 (124.0)

*1: Models with roof rail

*2: Models without roof rail

*3: 255/70R16 tyre equipped models

*4: 255/60R18 tyre equipped models

KING CAB

mm (in)

Body type	King Cab	
Overall length	Models without bed and rear bumper	5,120 (201.6)
	Models with bed and without rear bumper	5,225 (205.7)
	Models with bed and rear bumper	5,255 (206.9)
Overall width	Narrow body models	1,790 (70.5)
	Wide body models	1,850 (72.8)
Overall height	Two-Wheel Drive (2WD) models	1,780 (70.1)*1
	Four-Wheel Drive (4WD) models	1,780 (70.1)*1
		1,785 (70.3)*2
		1,790 (70.5)*3
Front tread	Two-Wheel Drive (2WD) models	1,550 (61.0)*1
	Four-Wheel Drive (4WD) models	1,550 (61.0)*1
		1,570 (61.8)*2*3
Rear tread	Two-Wheel Drive (2WD) models	1,550 (61.0)*1
	Four-Wheel Drive (4WD) models	1,550 (61.0)*1
		1,570 (61.8)*2*3
Wheelbase	3,150 (124.0)	

*1: 205R16C tyre equipped models

*2: 255/70R16 tyre equipped models

*3: 255/60R18 tyre equipped models

WHEN TRAVELLING OR REGISTERING IN ANOTHER COUNTRY

When planning to travel in another country or region, find out whether the fuel required for your vehicle is available in that country or region. Using a low octane/cetane rated fuel may cause engine damage. Therefore, be sure that the required fuel is available wherever you go. For additional information regarding recommended fuel, see earlier in this section.

When transferring the registration of your vehicle to another country, state, province or district, contact the appropriate authorities to find out that the vehicle complies with the local legal requirements. In some cases, a vehicle cannot meet the legal requirements, and it may be necessary to modify the vehicle to meet local laws and regulations. In addition, there may be possibilities that a vehicle cannot be adapted in certain areas.

The laws and regulations for motor vehicle emission control and safety standards vary according to the country, state, province or district; therefore, the vehicle specification may differ.

When any vehicles are to be taken into another country, state, province or district, its modification, transportation, registration, and any other expenses which may result, are the responsibility of the user. RENAULT is not responsible for any inconveniences that may result.

VEHICLE IDENTIFICATION

It is prohibited to cover, paint, weld, cut, drill, alter or remove Vehicle Identification Number (VIN).

VEHICLE IDENTIFICATION LABEL

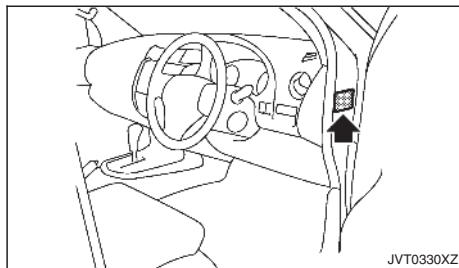

The vehicle identification label is affixed as illustrated.

VEHICLE IDENTIFICATION NUMBER (VIN) PLATE

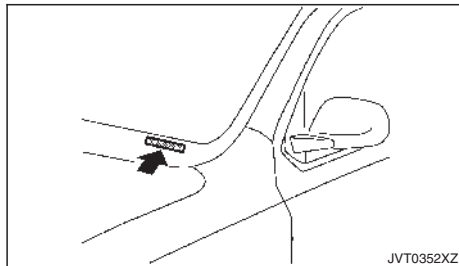

The vehicle identification number plate is attached as shown. This number is the identification for your vehicle and is used in the vehicle registration.

VEHICLE IDENTIFICATION NUMBER (VIN)

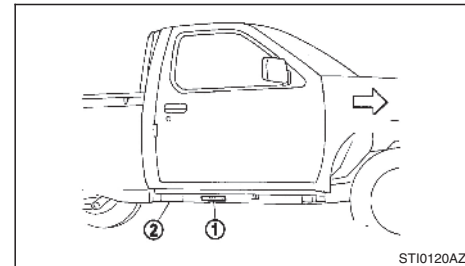

The vehicle identification number (chassis number) ① is stamped on the frame ② as shown.

ENGINE SERIAL NUMBER

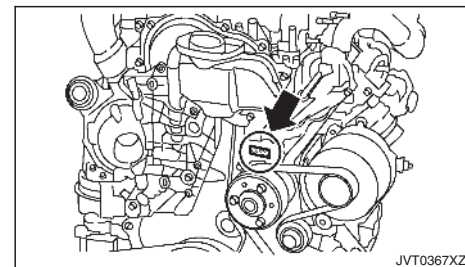

M9T 2.3DCI engine

The number is stamped on the engine as shown.

INSTALLATION OF AN RF TRANSMITTER

TYRE PLACARD

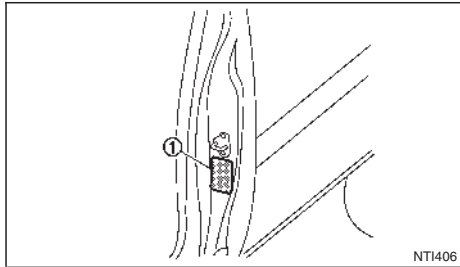

The cold tyre pressures are shown on the tyre placard affixed to the driver's side rear access door (King Cab model).

AIR CONDITIONER SPECIFICATION LABEL

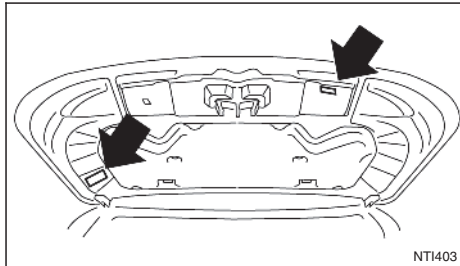

The air conditioner specification labels are attached to the underside of the bonnet as shown.

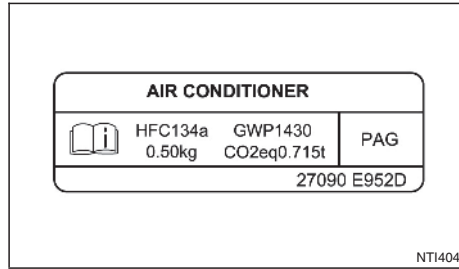

For countries conforming to UN regulation No.10 or equivalent:

The installation of an RF transmitter in your vehicle could affect electric equipment systems. Be sure to check with your approved dealer or qualified workshop for precautionary measures or special instructions regarding installation. Upon request, your approved dealer or qualified workshop will provide the detailed information (frequency band, power, antenna position, installation guide, etc.) regarding installation.

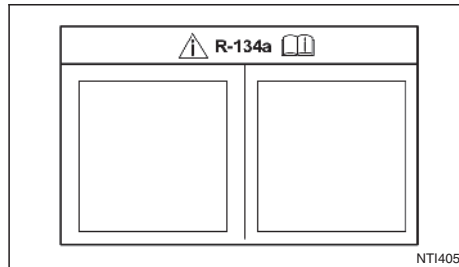

The text on the larger label states "[Contains fluorinated greenhouse gases]".

RADIO APPROVAL NUMBER AND INFORMATION

RADIO FREQUENCY APPROVAL

All radio frequency products fitted to the vehicle range during production conform to the requirements of the Radio Equipment Directive (RED) 2014/53/EU.

The countries covered by this directive, or those which accept it, are: Albania, Austria, Belgium, Bosnia & Herzegovina, Bulgaria, Croatia, Cyprus, Czech Republic, Denmark, Estonia, Finland, France, French Guyana, Georgia, Germany, Greece, Guadeloupe, Hungary, Iceland, Ireland, Italy, Kosovo, Latvia, Liechtenstein, Lithuania, Luxembourg, Macedonia, Malta, Martinique, Mayotte, Monaco, Montenegro, Netherlands, Norway, Poland, Portugal, Reunion, Romania, Saint Pierre & Miquelon, San Marino, Slovakia, Slovenia, Spain, Sweden, Switzerland, Turkey, Tuvalu, United Kingdom.

VEHICLE RADIO FUNCTIONS		
Frequency Range	Technology	Power/Magnetic Field
125 kHz (119 – 135 kHz)	Remote Keyless Entry Transponder Ring	≤ 42 dBμA/m at 10 m
433 MHz (433.05 – 434.79 MHz)	Tyre Pressure Monitoring	≤ 10 mW e.i.r.p.
433.92 MHz (433.05 MHz – 434.79 MHz)	Remote Keyless Entry	≤ 10 mW e.i.r.p.
20 kHz (9 – 90 kHz)	Keyless Go system	≤ 72 dBμA/m at 10 m
2.4 GHz (2400 – 2483.5 MHz)	Bluetooth®, Wi-Fi	≤ 100 mW e.i.r.p.
824 – 894 MHz	GSM 850 (2G)	≤ 39 dBm e.i.r.p.
880 – 960 MHz	GSM 900 (2G)	≤ 39 dBm e.i.r.p.
1710 – 1880 MHz	GSM 1800 (2G)	≤ 36 dBm e.i.r.p.
1850 – 1890 MHz	GSM 1900 (2G)	≤ 33 dBm e.i.r.p.
1922 – 2168 MHz	W-CDMA Band I (3G)	≤ 24 dBm e.i.r.p.
24.05 – 24.25 GHz	24 GHz ISM Radar	≤ 100 mW e.i.r.p.
24.25 – 26.65 GHz	24 GHz UWB Radar	≤ -41,3 dBm/MHz e.i.r.p. mean ≤ 0 dBm/50MHz e.i.r.p. peak
76 – 77 GHz	77 GHz Radar	≤ 55 dBm e.i.r.p.

NOTE

NOTE

NOTE

10 Index

360° camera	4-11
- Guide lines	4-14, 4-16
- Operating tips	4-18
- Operation	4-13

A

Active Emergency Braking system	5-29
AdBlue®	5-3, 8-7
- Filler lid	3-19
Air bags	
- Front passenger air bag switch	1-36
- Overview	0-2
- Repair and replacement	1-38
- Status light	2-10
- Supplemental Restraint System (SRS)	1-29
Air cleaner filter	8-15
Air conditioner	
- Refrigerant and lubricant	9-2
- Specification label	9-8
- Vents	4-19
Air fresheners	7-4
Anti-Lock Braking System (ABS)	5-43
- Electronic Stability Programme (ESP)	5-27
- Self test	5-43
Approval numbers	9-9
Audible reminders	2-12, 2-5
Audio	
- Bluetooth® audio streaming main operation	4-44
- FM AM radio with CD (Type A)	4-34
- FM AM radio with CD (Type B)	4-48

- iPod player operation	4-41, 4-51
- Steering-wheel switches	4-54
- Touchscreen Navigation	4-53
Automatic transmission (AT)	
- Automatic transmission fluid (ATF)	8-8
- Operation	5-13
- Shift lock release	5-16
- Shifting	5-14
- Starting	5-14

B

Battery	8-12
- Caution label	8-12
- Checking fluid level	8-13
- Cold weather	5-44
- Jump starting	6-11
- Key battery replacement	8-13
- Remote Control Key battery replacement	8-14
- Saver system	3-10
- Variable voltage control system	8-17
- Vehicle battery	8-13
Bluetooth®	
- Hands-Free Phone System	4-55, 4-61
- Operation	4-43
- Phone settings	4-55, 4-61
- Settings	4-43
Brakes	5-42, 8-9
- Active Emergency Braking system	5-29
- Anti-lock Braking System (ABS)	5-43
- Booster	8-9

- Checking footbrake	8-9
- Checking parking brake	8-9
- Electronic Stability Programme (ESP)	5-27
- Fluid	8-10, 9-2
- Pad wear warning	8-9
- Precautions	5-42

C

Capacities and recommendations

- Brake and clutch fluid	9-2
- Coolant	9-2
- Fuel	9-2
- Oil	9-2
- Refrigerant	9-2

Cargo

- Bed	3-20
-------------	------

Changing

- Engine oil filter	8-7
- Flat tyre	6-4

Checking

- Battery fluid level	8-13
- Brake pedal	8-9
- Engine oil level	8-6
- Parking brake	8-9

Child restraints

- Anchorage	1-20, 1-21
- ISOFIX	1-18, 1-19, 1-22
- Precautions	1-14
- Seat belt installation	1-24
- Universal child restraints (front and rear seats)	1-15

Child safety

- Seat belts	1-11
--------------------	------

Cleaning

- Chrome parts	7-3
----------------------	-----

- Exterior	7-2
- Floor mats	7-4
- Glass	7-3, 7-4
- Headlights	2-30
- Interior	7-4
- Seat belts	7-5
- Side step boards	7-3
- Underbody	7-3
- Washing	7-2
- Waxing	7-3
- Wheels	7-3
- Window washer nozzle	8-16
Clock	2-25
Clutch	
- Fluid	8-11, 9-2
Cockpit	
- Overview	0-6
Cold weather	5-44
- Battery	5-44
- Corrosion protection	5-45
- Engine coolant	5-44
- Parking brake	5-45
- Tyre equipment	5-44
- Winter equipment	5-45
Compass	
- Vehicle information display	2-19
Console box	2-34
Console side pockets	2-35
Coolant	
- Capacity	9-2
- Changing engine coolant	8-6
- Checking coolant level	8-6
- Cold weather	5-44
- Engine cooling system	8-5
Corrosion protection	7-5
- Cold weather	5-45

- Environmental factors	7-5
Cup holders	2-35
- Bottle holder	2-35

D

Defogger	
- Rear window	2-29
Diesel	
- Capacity	9-2
- Filler lid	3-18
- Fuel recommendation	9-2
Dimensions	9-5
- Engine	9-3
- Tyres	9-4
Display	
- Reversing camera	4-7
Doors	
- Tailgate	3-20
Drive belt	8-8
Driving	5-13
- Automatic Transmission (AT)	5-13
- Care	5-8
- Cold weather	5-44
- On-pavement and off-road precautions	5-6
- Precautions	5-2
- Stop/Start System	5-17
- Wet conditions	5-8

E

ECO drive report	5-37
Electronic Stability Programme (ESP)	5-27
- OFF switch	5-28

Engine	
- Air cleaner filter	8-15
- Changing engine coolant	8-6
- Changing oil filter	8-7
- Checking coolant level	8-6
- Checking oil level	8-6
- Compartment	0-11
- Cooling system	8-5
- Drive belt	8-8
- Oil Disposal	8-7
- Overheat	6-13
- Serial number	9-7
- Specifications	9-3
- Starting (With Remote Control Key)	5-13
- Starting (Without Remote Control Key)	5-12
- Turbocharger	5-8
Exhaust gas (Carbon Monoxide)	5-3
Exterior	
- Lights – Bulb information	8-22
- Overview	0-3

F

Filter	
- Air cleaner	8-15
Flat tyre	6-2
- Emergency tyre puncture repair kit	6-7
- Jacking	6-4
- Preparing tools	6-2
Floor mats	7-4
Fluids	
- Automatic transmission Fluid (ATF)	8-8
- Brake	8-10
- Clutch	8-11
- Coolant	8-5

- Power steering	8-8
- Recommendations and capacities	9-2
- Window washer	8-11
Fog lights	
- Front — Location	0-3
- Front — Operation	2-28
- Rear — Operation	2-28
- Replacement	8-24
Four-wheel drive	5-20
- 4WD warning light	5-25
- Operation	5-24
Freeing trapped vehicle	6-16
Fuel	
- Capacity	9-2
- Filler lid	3-18
- Gauge	2-2
- Information	9-2
Fuses	8-18
- Engine compartment	8-18
- Extended storage	8-20
- Passenger compartment	8-19

G

Gauges	
- Meters and gauges	2-2
- Odometer	2-2
- Speedometer	2-2
Glass	
- Cleaning	7-4
Glove box	2-34

H

Hands-Free Phone System	4-55, 4-61
Hazard indicator flasher switch	6-2
Hazard indicator operation	
- Remote keyless entry	3-15
Head restraints	1-6
- Adjustment	1-6, 1-8
- Installation	1-7
- Removal	1-7
Headlights	
- Cleaner	2-30
- Replacement (bulb)	8-21
Heated seats	
- Operation	1-5
Hill descent control system	5-31
- Switch	5-32
Hill Start Assist system	5-32

I

Ignition	
- Ignition switch (Models without Remote Control Key system)	5-8
- Ignition switch positions (With Remote Control Key system)	5-11
- Ignition switch positions (Without Remote Control Key system)	5-9
- Push-button ignition switch	5-10
Indicator lights	2-10
Injured persons	1-11
Instrument panel	
- Overview	0-8
Integrated key fob	
- Battery replacement	8-13

Interior	
- Cleaning	7-4
- Lights – Information	8-22
- Lights – Operation	2-38
iPod player operation	4-41, 4-51
ISOFIX	
- Anchor locations	1-20
- Child restraints	1-18, 1-19
- Installation	1-22

J

Jump starting	6-11
---------------	------

K

Keys	3-2
- Battery replacement	8-13
- Radio approval numbers and information	9-9
- Remote Control Key	3-7
- Remote Control Key operating range	3-8
- Remote keyless entry	3-14
- Using Remote Control Key system	3-8

L

Labels	
- Air conditioner	9-8
- Battery caution label	8-12
- Tyres	9-8
- Vehicle identification	9-7
Lights	8-21
- Exterior – Bulb information	8-22
- Headlight bulb replacement	8-21

- Interior – Information	8-22
- Locations	8-23
- Replacement	8-24
- Switch – Fog lights	2-28
- Switch – Hazard warning flasher	6-2
- Warning lights	2-5
Locks	
- Hazard indicator operation	3-15
Lumbar support	1-4

M

Maintenance	
- General maintenance	8-2
- Precautions	8-4
- Requirements	8-2
- Seat belts	1-14
Manual Transmission (MT)	
- Operation	5-16
- Shifting	5-16
- Starting	5-16
Map lights	
- Operation	2-38
Meters and gauges	2-2
- Brightness control	2-4
- Engine coolant temperature	2-3
- Fuel	2-2
- Odometer	2-2
- Overview	0-10
- Speedometer	2-2
- Tachometer	2-3
Mirrors	
- Adjustment	3-25
- Automatic anti-dazzling inside mirror	3-24
- Folding	3-25

- Rear-view (Inside) 3-23
- Rear-view (Outside) 3-25
- Vanity mirror 3-26
- Mobile phone integration for FM AM radio with CD
player 4-55, 4-61

O

- Odometer 2-2
- Off-road
 - Precautions 5-6
- Oil
 - Capacity 9-2
 - Changing engine oil filter 8-7
 - Checking oil level 8-6
 - Disposal 8-7
 - Engine oil 8-6
- Overheat
 - Engine 6-13
- Overview
 - Cockpit 0-6
 - Engine compartment 0-11
 - Exterior 0-3
 - Instrument panel 0-8
 - Meters and gauges 0-10
 - Passenger compartment 0-5
 - Seats, Seat belts, Supplemental restraint system ... 0-2

P

- Parking 5-38
 - Brake 3-26
 - Parking sensor system 5-39
- Parking brake
 - Checking 8-9

- Cold weather 5-45
- Parking sensors 5-39
 - Indicator 5-39
 - OFF switch 5-40
- Passenger compartment 0-5
- Phone
 - Bluetooth® Hands-Free 4-55, 4-61
 - Mobile phone integration 4-55, 4-61
- Power
 - Outlet 2-33
 - Power steering 5-42
 - Steering fluid 8-8
- Precautions
 - Child restraints 1-14
 - Exhaust gas 5-3
 - Maintenance 8-4
 - Off-road driving 5-6
 - On-pavement driving 5-6
 - Parking 5-38
 - Push-button ignition switch 5-10
 - Seat belts 1-9
 - Supplemental Restraint System 1-29
 - Towing 6-14
 - Trailer towing 5-41
- Pregnant women 1-11
- Protection
 - Corrosion 7-5
- Push starting 6-13

R

- Radio
 - Approval numbers and information 9-9
 - FM AM radio with CD (Type A) 4-34
 - FM AM radio with CD (Type B) 4-48

- Touchscreen Navigation	4-53
- Transmitter	9-8
Rear window	
- Defogger	2-29
Rearview	
- Mirrors - Inside	3-23
- Mirrors - Outside	3-25
Remote Control Key	3-7
- Battery - Discharge	5-12
- Operating range	3-8
- Operation	3-8
- Push-button ignition switch	5-10
- Radio approval numbers and information	9-9
- Remote keyless entry	3-14
- Starting engine	5-13
- System	5-10
- Troubleshooting guide	3-12
- Warning signals	3-10
Remote keyless entry	3-14
Replacement	
- Air bags	1-38
- Air cleaner filter	8-15
- Battery (Key fob)	8-13
- Engine coolant	8-6
- Engine oil	8-7
- Engine oil filter	8-7
- Fuses	8-18
- Lights	8-24
- Remote Control Key battery	8-14
- Wiper blades	8-17
Reversing camera	4-7
- Settings	4-9
- Tips	4-10
Roof rails	2-35
Room light	
- Operation	2-39

- Replacement	8-24
Running-in schedule	5-2

S

Safety	
- Head restraints	1-6
Seat belts	1-9
- Adjustment	1-12
- CENTER mark	1-11
- Checking	1-13
- Child safety	1-11
- Children - Infants	1-11
- Children - Larger	1-11
- Children - Small	1-11
- Cleaning	7-5
- Injured persons	1-11
- Maintenance	1-14
- Precautions	1-9
- Pregnant women	1-11
- Three-point type	1-12
- Two-point type	1-13
Seats	1-2
- Adjustment (Manual)	1-2
- Adjustment (Power)	1-3
- Folding	1-5
- Front seats	1-2
- Head restraints	1-6
- ISOFIX child restraints	1-18, 1-19
- Jump seat	1-6
- Lumbar support	1-4
- Rear	1-5
- Universal child restraints (front and rear seats)	1-15
Security system	3-15

Service	
- Maintenance	8-2
Spare tyre	6-4
Speed limiter	
- Operation	5-36
Speedometer	2-2
Starting	
- Jump starting	6-11
- Push starting	6-13
- Without Remote Control Key	5-12
Steering	
- Power steering system	5-42
- Steering wheel switches for phone control	4-60
Steering wheel	3-23
- Adjustment	3-23
- Switches — Audio control	4-54
- Switches — Hands-free telephone control	4-55, 4-61
Stop/Start System	5-17
- Display	5-18
- OFF switch	5-20
Storage	2-34
- Card holder	2-36
- Console box	2-34
- Console side pockets	2-35
- Cup holders	2-35
- Glove box	2-34
- Roof rails	2-35
- Sunglasses holder	2-34
Sun visors	2-36
- Card holder	2-36
Sunroof	2-37
- Operation	2-37
Sunshade	2-37
Supplemental Restraint System (SRS)	1-29
- Overview	0-2
- Repair and replacement procedure	1-38

Switches	
- Defogger	2-29
- Electronic Stability Programme (ESP) OFF switch	5-28
- Fog lights	2-28
- Hazard indicator flasher switch	6-2
- Headlight cleaner	2-30
- Hill descent control	5-32
- Ignition switch	5-8
- Interior lights	2-38
- Parking sensor system	5-40
- Seat adjustment	1-3
- Seat heating	1-5
- Steering-wheel — Audio	4-54
- Wiper and washer	2-29

T

Tailgate	3-20
Theft warning system	3-15
Tools	6-2
Touchscreen Navigation	4-53
Towing	
- Precautions	6-14
- Recommendations	6-14
- Recommended towing for four-wheel drive (4WD) models	6-15
- Recommended towing for two-wheel drive (2WD) models	6-14
- Trailer	5-41
- Your vehicle	6-14
Trailer	
- Brakes	5-41
- Precautions	5-41
- Safety chains	5-41
- Towing	5-41

- Trailer detection	5-41
- Tyre pressure	5-41
Transferring registration to another country	9-7
Transmission	
- Automatic transmission fluid (ATF)	8-8
Transmitter	
- Radio	9-8
Travelling	9-7
Turbocharger	5-8
Turn signal	
- Replacement	8-24
Tyres	
- 4WD model	5-25
- Age	8-28
- Cold weather	5-44
- Flat tyre	6-2
- Inflation pressure	8-27
- Placard	9-8
- Repairing flat tyre	6-7
- Rotation	8-28
- Sizes	9-4
- Snow chains	8-27
- Types	8-27
- Wear and damage	8-28
- Wheels and tyres	8-27

U

Universal child restraints	
- Front and rear seats	1-15

V

Vanity mirror	
- Lights	2-39

Variable voltage control system	8-17
Vehicle battery	8-13
Vehicle identification	9-7
- Air conditioner label	9-8
- Engine serial number	9-7
- Label	9-7
- Number (VIN) (chassis number)	9-7
- Number (VIN) plate	9-7
- Tyre placard	9-8
Vehicle security	5-42
- Theft warning system	3-15
Vents	4-19

W

Warning/indicator lights and audible reminders	
- Warning lights	2-5
Wheels	
- Blocking	6-4
- Cleaning	7-3
- Installation	6-7
- Removal	6-4
- Sizes	9-4
- Stowing	6-7
Window washer fluid	8-11
Windows	
- Defogger	2-29
Windscreen	
- Wiper and washer switch	2-29
Winter	
- Precautions	5-44
- Special equipment	5-45
Wipers	
- Blades replacement	8-17
- Operation (Windscreen)	2-29

- Washer nozzle 8-16
- Window washer cleaner fluid 8-11
- Wiper and washer switch 2-29

PETROL STATION INFORMATION

FUEL INFORMATION

Diesel engine*

Compatible Fuels for Diesel Engine	
The diesel engine is compatible with current and future European standards for bio-fuel.	
	Diesel conforming to EN16734 and mixed with a bio-fuel conforming to EN14214 (incorporating between 0 and 10% Fatty Acid Methyl Esters).

M9T 2.3DCI engine:

Diesel fuel above 50 cetane and with less than 10 ppm of sulphur (EN590) must be used.

- * If two types of diesel fuel are available, use summer or winter fuel properly according to the following temperature conditions.

Above -7°C (20°F) ... Summer type diesel fuel.

Below -7°C (20°F) ... Winter type diesel fuel.

CAUTION

Do not use home heating oil, petrol, or other alternate fuels in your diesel engine. The use of those or adding those to diesel fuel can cause engine damage.

Do not use summer fuel at temperatures below -7°C (20°F). The cold temperatures will cause wax to form in the fuel. As a result, it may prevent the engine from running smoothly.

TYRE COLD PRESSURE

See the tyre placard affixed to the driver's side centre pillar.

AIRBAG LABEL (where fitted)



NEVER use a rearward facing child restraint on a seat protected by an ACTIVE AIRBAG in front of it, DEATH or SERIOUS INJURY to the CHILD can occur.

NE JAMAIS utiliser un dispositif de retenue pour enfant de type dos à la route sur un siège protégé par un AIRBAG ACTIF placé devant lui. Cela peut entraîner la MORT de l'ENFANT ou des BLESSURES GRAVES.

Installieren Sie niemals ein entgegen der Fahrrichtung angeordnetes Kinderrückhaltesystem auf einem Sitz mit aktiviertem Frontairbag. Es könnte zum Tod oder schweren Verletzungen des Kindes führen.

No instalar nunca los sistemas de retención para niños (sillitas de niño) de espaldas al sentido de la marcha en el asiento del pasajero protegido por un AIRBAG frontal ACTIVO. Esto puede provocar la MUERTE del niño o DAÑARLE SERIAMENTE.

«NON INSTALLARE MAI un seggiolino per bambini rivolto con verso opposto al senso di marcia su un sedile protetto da un AIRBAG frontale ATTIVO. In caso di incidente questo potrebbe risultare molto pericoloso per l'incolumità del bambino.»

Plaats nooit een kinderzitje achterstevoren op de passagiersstoel voorin als de airbags van de voorpassagier niet zijn uitgeschakeld. Dit kan ernstige of zelfs dodelijke verwondingen van het kind veroorzaken.

NUNCA utilize um sistema de retenção de criança virado para a traseira num banco protegido por um AIRBAG ACTIVO à sua frente, porque pode ocorrer MORTE ou FERIMENTOS GRAVES na CRIANÇA.

W żadnym przypadku NIE NALEŻY stosować fotelików dla dzieci skierowanych twarzą do tyłu przed siedzeniami chronionymi AKTYWNA PODUSZKA POWIETRZNA. Może to doprowadzić do POWAŻNYCH OBRAŻEŃ lub nawet ŚMIERCI DZIECKA.

NIKDY nepoužívejte dětskou sedačku směřující dozadu na sedadle s AKTYVNÍM čelním AIRBAGEM, mohlo by dojít k USMRČENÍ nebo VÁŽNĚMU ZRANĚNÍ DÍTĚTE.

Önünde AKTIF BİR HAVA YASTIĞI ile korununan bir koltuğa hiç bir zaman yüzü geriye bakan bir çocuk koltuğu KOYMAYIN, bu ÇOCUĞUN ÖLÜMÜNE veya CİDDİ ŞEKİLDE YARALANMASINA neden olabilir.

Nu folositi NICIODATĂ un scaun pentru copil cu spatele la direcția de deplasare pe un scaun protejat de un AIRBAG ACTIV amplasat în fața sa, deoarece există riscul de DECES sau RĂNIRE GRAVĂ a copilului.

SOHA ne használnjon hátrafelé néző gyermekülést olyan ülésen, amelyet előlről AKTÍV LÉGZSÁK véd, mert az a GYERMEK HALÁLÁT vagy SÚLYOS SÉRÜLÉSÉT okozhatja.

“ΑΠΑΓΟΡΕΥΕΤΑΙ η τοποθέτηση παιδικού καθίσματος, με την πλάτη προς το εμπρόσθιο μέρος του αυτοκινήτου, στο κάθισμα του συνοδηγού, επειδή μπροστά του υπάρχει ΕΝΕΡΓΟΣ ΜΕΤΩΠΙΚΟΣ ΑΕΡΟΣΑΚΟΣ. Μπορεί να επέλθει, ΘΑΝΑΤΟΣ ή ΣΟΒΑΡΟΣ ΤΡΑΥΜΑΤΙΣΜΟΣ του ΠΑΙΔΙΟΥ”.

Använd ALDRIG en bakåtvänd barnstol på ett säte som skyddas av en AKTIVERAD AIRBAG framför det; LIVSFARA eller risk för ALLVARLIGA SKADOR.

ÄLÄ KOSKAAN käyttää kasvot taaksepäin suunnattua lastenistuinta istuimella, jossa on KÄYTÖSSÄ OLEVA TURVATYYNY. Seurauksena voi olla KUOLEMA tai LAPSEN VAKAVA LOUKKAANTUMINEN.

Brug ALDRIG et bagudvendt barnesæde på et sæde, der er beskyttet af en AKTIV AIRBAG foran det. Det kan resultere i DØD eller ALVORLIG PERSONSKADE på BARNET.

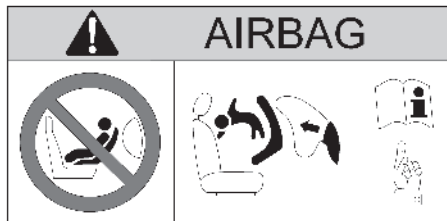

NEMOJTE upotrebljavati sjedalicu za djecu okrenutu prema natrag na sjedalu ispred kojega se nalazi zaštićeni **AKTIVNI ZRAČNI JASTUK**, može doći do **SMRTONOSNIH** ili **OZBILJNIH OZLJEDA** za **DIJETE**.

NIKOLI ne namestite otroškoga sedea, obrnjenoga v nasprotni smeri smeri vožnje, v primeru **VKLOPLJENE** varnostne blazine. To lahko povzroči **OTROKOVO SMRT** ali **HUDE TELESNE POŠKODBE**.

Никога не устанавляйте обращенное назад детское удерживающее сиденье на переднем пассажирском сиденье при неотключенной подушке безопасности. Это может привести к смерти ребенка или к тяжелым повреждениям.

NIKDY nepoužívajte detskú sedačku smerujúcu dozadu na sedadle s **AKTÍVNÝM** čelným **AIRBAGOM**, mohlo by prísť k **USMRTENIU** alebo **VÁŽNEMU ZRANENIU** **DIETĀĽA**.

ÄRGE kasutage seljaga sõidusuunas laste turvatooli istmel, mille ees on **AKTIIVNE TURVAPADI**. **LAPS** võib saada **TÕSISE KEHAVIGASTUSE** või **HUKKUDA**.

NEIEVIETOJĪET ar skatu pretēji braukšanas virzienam vērstu bērnu sēdekļīti šajā sēdekļī, ja tā priekšā uzstādītais **GAISA SPILVENS** ir **AKTIVIZĒTS**, – tas **BĒRĒNAM** var radīt **NOPIETNAS TRAUMAS** vai pat izraisīt **BĒRĒNA NĀVI**.

NUNCA utilize uma cadeirinha protetora para crianças voltada para a traseira em um assento que seja protegido por um **AIRBAG ATIVO** na frente do assento. Podem ocorrer **MORTE** ou **FERIMENTOS GRAVES** para a **CRANÇA**.

NIEKADA nevežkite vaiku prie automobīlio sēdynēs atvirkščiāi judējimo krypčiāi pritvirtintoje specialioje kėdutėje, jeigu ši sėdynė apsaugota **VEIKIANČIA SAUGOS PAGALVE**, nes **VAIKUI** kylā **MIRTINAS** ar **SUNKAUS SUŽEIDIMO** pavojus.

Ніколи не встановлюйте дитяче крісло спинкою вперед на сидінні, передня **ПОДУШКА БЕЗПЕКИ** якого не заблокована. Ризик **ЗАГИБЕЛІ** або **ТЯЖКИХ ТРАВМ** дитини.

„Никога на използвайте детско столче за автомобил, монтирано с гръб към движението, на седалка оборудвана с предпазна въздушна възглавница пред нея. Съществува риск за живота или сериозно нараняване на детето!“

يحذر نهائياً تثبيت مقعد الطفل بشكل عكسي على القعد المحمي بوسادة هوائية نشطة أمام مقعد الطفل، فمن الممكن أن يتسبب ذلك في وفاة الطفل أو إصابته بجروح خطيرة

ALDREI má nota festingar sem snúa afturábak á sæti sem varíð er með **ACTIVE AIRBAG** að framan. Það getur valdið **DAUÐA** eða **ALVARLEGUM MEIÐSLUM** á **BARNINU**.

Na sedež, ki je spredaj zaščiten z **ZRAČNO BLAZINO**, **NIKOLI** ne namestite otroškega sedeža tako, da otrok gleda nazaj; nevarnost **SMRTI** ali **RESNE TELESNE POŠKODBE** **OTROKA**

هرگز از کمر بند کودک رو به پشت در روبروی صندلی حفاظت شده توسط **ACTIVE AIRBAG** (کیسه هوای فعال) استفاده نکنید. این کار ممکن است باعث مرگ یا جراحت شدید در کودک شود.

절대로 능동형 에어백이 전면에 설치된 좌석에 후향식 어린이 보호시트를 사용하지 마십시오. 어린이에게 심각한 상해를 입히거나 사망에 이르게 할 수 있습니다.

前部に作動可能なエアバッグが装着されているシートに、後ろ向きのチャイルドシートを絶対に使用しないでください。お子様に死や大けがを招く恐れがあります。

禁止在座椅前部安全气囊激活的情况下，在该座椅上使用后向儿童安全座椅，可能造成儿童严重受伤甚至死亡。

QUICK REFERENCE

In case of emergency ... 6-2

(Flat tyre, engine will not start, overheating,
towing)

How to start the engine ... 5-2

How to read the meters and gauges ... 2-2

Maintenance and do-it-yourself ... 8-2

Technical information ... 9-2

SERVICE SHEETS (1/6)

VIN:.....

Date:		Km (Miles):		Invoice number:		Comments/miscellaneous	
Type of operation: Service		<input type="checkbox"/>		Stamp			
		<input type="checkbox"/>					
Anti-corrosion check:		OK <input type="checkbox"/>		Not OK <input type="checkbox"/>			
*See specific page							
Date:		Km (Miles):		Invoice number:		Comments/miscellaneous	
Type of operation: Service		<input type="checkbox"/>		Stamp			
		<input type="checkbox"/>					
Anti-corrosion check:		OK <input type="checkbox"/>		Not OK <input type="checkbox"/>			
*See specific page							
Date:		Km (Miles):		Invoice number:		Comments/miscellaneous	
Type of operation: Service		<input type="checkbox"/>		Stamp			
		<input type="checkbox"/>					
Anti-corrosion check:		OK <input type="checkbox"/>		Not OK <input type="checkbox"/>			
*See specific page							

SERVICE SHEETS (2/6)

VIN:.....

Date:		Km (Miles):		Invoice number:		Comments/miscellaneous	
Type of operation: Service		<input type="checkbox"/>		Stamp			
		<input type="checkbox"/>					
Anti-corrosion check:		OK <input type="checkbox"/>		Not OK <input type="checkbox"/>			
*See specific page							
Date:		Km (Miles):		Invoice number:		Comments/miscellaneous	
Type of operation: Service		<input type="checkbox"/>		Stamp			
		<input type="checkbox"/>					
Anti-corrosion check:		OK <input type="checkbox"/>		Not OK <input type="checkbox"/>			
*See specific page							
Date:		Km (Miles):		Invoice number:		Comments/miscellaneous	
Type of operation: Service		<input type="checkbox"/>		Stamp			
		<input type="checkbox"/>					
Anti-corrosion check:		OK <input type="checkbox"/>		Not OK <input type="checkbox"/>			
*See specific page							

SERVICE SHEETS (3/6)

VIN:.....

Date:		Km (Miles):		Invoice number:		Comments/miscellaneous	
Type of operation: Service		<input type="checkbox"/>		Stamp			
		<input type="checkbox"/>					
Anti-corrosion check:		OK <input type="checkbox"/>		Not OK <input type="checkbox"/>			
*See specific page							
Date:		Km (Miles):		Invoice number:		Comments/miscellaneous	
Type of operation: Service		<input type="checkbox"/>		Stamp			
		<input type="checkbox"/>					
Anti-corrosion check:		OK <input type="checkbox"/>		Not OK <input type="checkbox"/>			
*See specific page							
Date:		Km (Miles):		Invoice number:		Comments/miscellaneous	
Type of operation: Service		<input type="checkbox"/>		Stamp			
		<input type="checkbox"/>					
Anti-corrosion check:		OK <input type="checkbox"/>		Not OK <input type="checkbox"/>			
*See specific page							

SERVICE SHEETS (4/6)

VIN:.....

Date:		Km (Miles):		Invoice number:		Comments/miscellaneous	
Type of operation: Service		<input type="checkbox"/>		Stamp			
		<input type="checkbox"/>					
Anti-corrosion check:		OK <input type="checkbox"/>		Not OK <input type="checkbox"/>			
*See specific page							
Date:		Km (Miles):		Invoice number:		Comments/miscellaneous	
Type of operation: Service		<input type="checkbox"/>		Stamp			
		<input type="checkbox"/>					
Anti-corrosion check:		OK <input type="checkbox"/>		Not OK <input type="checkbox"/>			
*See specific page							
Date:		Km (Miles):		Invoice number:		Comments/miscellaneous	
Type of operation: Service		<input type="checkbox"/>		Stamp			
		<input type="checkbox"/>					
Anti-corrosion check:		OK <input type="checkbox"/>		Not OK <input type="checkbox"/>			
*See specific page							

SERVICE SHEETS (5/6)

VIN:.....

Date:		Km (Miles):		Invoice number:		Comments/miscellaneous	
Type of operation: Service		<input type="checkbox"/>		Stamp			
		<input type="checkbox"/>					
Anti-corrosion check:		OK <input type="checkbox"/>		Not OK <input type="checkbox"/>			
*See specific page							
Date:		Km (Miles):		Invoice number:		Comments/miscellaneous	
Type of operation: Service		<input type="checkbox"/>		Stamp			
		<input type="checkbox"/>					
Anti-corrosion check:		OK <input type="checkbox"/>		Not OK <input type="checkbox"/>			
*See specific page							
Date:		Km (Miles):		Invoice number:		Comments/miscellaneous	
Type of operation: Service		<input type="checkbox"/>		Stamp			
		<input type="checkbox"/>					
Anti-corrosion check:		OK <input type="checkbox"/>		Not OK <input type="checkbox"/>			
*See specific page							

SERVICE SHEETS (6/6)

VIN:.....

Date:		Km (Miles):		Invoice number:		Comments/miscellaneous	
Type of operation: Service		<input type="checkbox"/>		Stamp			
		<input type="checkbox"/>					
Anti-corrosion check:		OK <input type="checkbox"/>		Not OK <input type="checkbox"/>			
*See specific page							
Date:		Km (Miles):		Invoice number:		Comments/miscellaneous	
Type of operation: Service		<input type="checkbox"/>		Stamp			
		<input type="checkbox"/>					
Anti-corrosion check:		OK <input type="checkbox"/>		Not OK <input type="checkbox"/>			
*See specific page							
Date:		Km (Miles):		Invoice number:		Comments/miscellaneous	
Type of operation: Service		<input type="checkbox"/>		Stamp			
		<input type="checkbox"/>					
Anti-corrosion check:		OK <input type="checkbox"/>		Not OK <input type="checkbox"/>			
*See specific page							

ANTICORROSION CHECK (1/6)

If the continuation of the warranty is subject to repair, it is indicated below.

VIN:.....

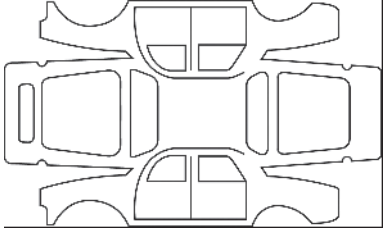
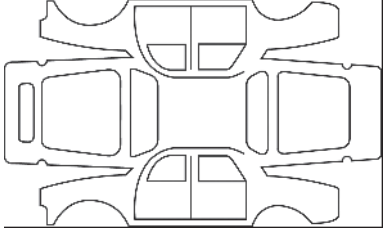
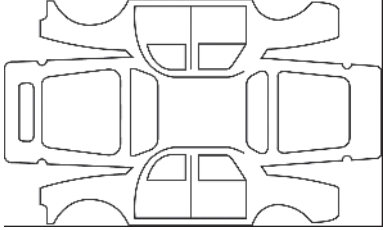
Corrosion repair operation to be carried out:		Stamp
Date of repair:		
Repair to be carried out:		Stamp
Date of repair:		
Repair to be carried out:		Stamp
Date of repair:		

ANTICORROSION CHECK (2/6)

If the continuation of the warranty is subject to repair, it is indicated below.

VIN:.....

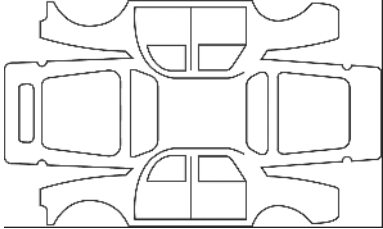
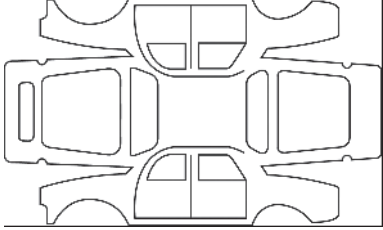
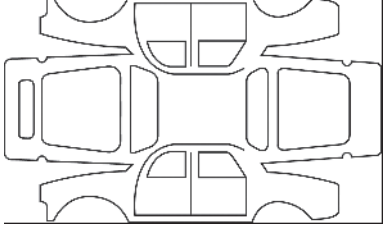
Corrosion repair operation to be carried out:		Stamp
Date of repair:		
Repair to be carried out:		Stamp
Date of repair:		
Repair to be carried out:		Stamp
Date of repair:		

ANTICORROSION CHECK (3/6)

If the continuation of the warranty is subject to repair, it is indicated below.

VIN:.....

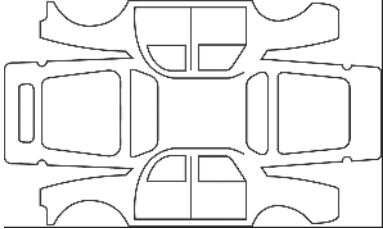
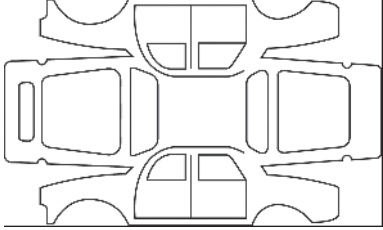
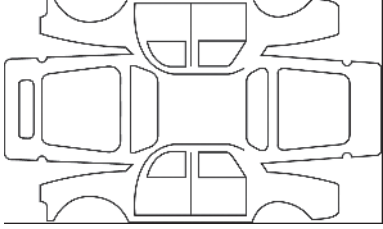
Corrosion repair operation to be carried out:		Stamp
Date of repair:		
Repair to be carried out:		Stamp
Date of repair:		
Repair to be carried out:		Stamp
Date of repair:		

ANTICORROSION CHECK (4/6)

If the continuation of the warranty is subject to repair, it is indicated below.

VIN:.....

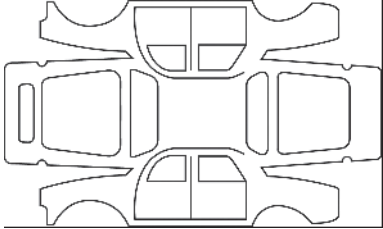
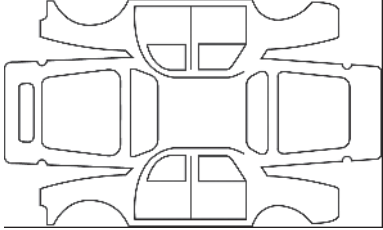
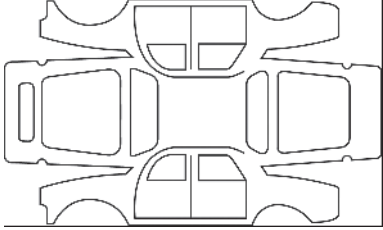
Corrosion repair operation to be carried out:		Stamp
Date of repair:		
Repair to be carried out:		Stamp
Date of repair:		
Repair to be carried out:		Stamp
Date of repair:		

ANTICORROSION CHECK (5/6)

If the continuation of the warranty is subject to repair, it is indicated below.

VIN:.....

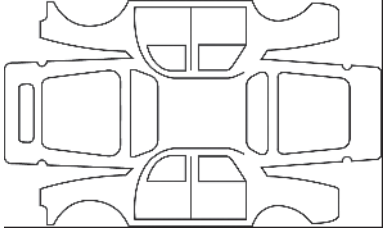
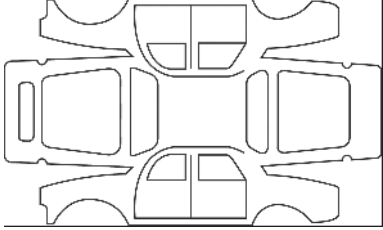
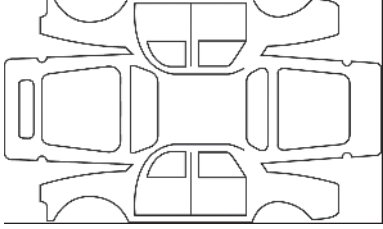
Corrosion repair operation to be carried out:		Stamp
Date of repair:		
Repair to be carried out:		Stamp
Date of repair:		
Repair to be carried out:		Stamp
Date of repair:		

ANTICORROSION CHECK (6/6)

If the continuation of the warranty is subject to repair, it is indicated below.

VIN:.....

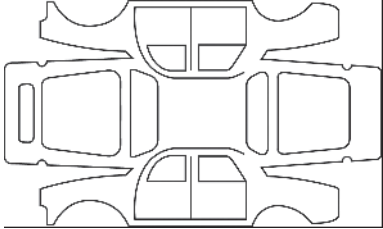
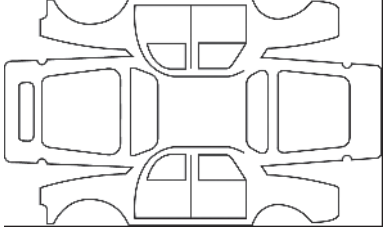
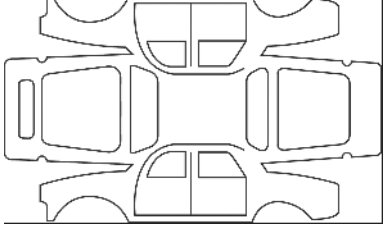
Corrosion repair operation to be carried out:		Stamp
Date of repair:		
Repair to be carried out:		Stamp
Date of repair:		
Repair to be carried out:		Stamp
Date of repair:		

SECURITY INFORMATION

As owner of this vehicle important codes have been supplied to you that may be required by your RENAULT dealer to duplicate keys or re-pair the radio.

Please fill in the allocated areas or attach sticker(s) if available. Remove this page and keep it in a safe place, **not in the vehicle**

When selling your vehicle, we kindly request you to hand over this page to the buyer.

SECURITY INFORMATION

Radio security code
(where fitted)

--	--	--	--

Key number

--	--	--	--	--

Wheel lock key code
(where fitted)

--	--	--	--	--	--	--	--

Remove this page from the manual and keep it in a safe place, **not in the vehicle**.

When selling your vehicle, we kindly request you to hand over this page to the buyer.



