

SCENIC E-TECH 100% ELECTRIC

vehicle user manual





Welcome to your new electric vehicle

This user manual contains the information required:

- for you to familiarise yourself with your vehicle, to use it to its best advantage and to fully benefit from all the functions and the technical developments it incorporates.
- to ensure that it always gives the best performance by following the simple, but comprehensive advice concerning regular maintenance.
- to enable you to deal quickly with minor faults not requiring specialist attention.

It is well worth taking a few minutes to read this manual to familiarise yourself with the information and guidelines it contains about the vehicle and its functions and new features. If certain points are still unclear, our Network technicians will be only too pleased to provide you with any additional information.

For guidance, please see the following symbols:

 and  visible in the vehicle – indicate that you should consult the manual for detailed information and/or limits on operations with respect to your vehicle's equipment.

→ anywhere in the manual indicates a transfer to a page.



anywhere in the manual indicates a hazard, danger or a safety recommendation.

The description of the models given in this manual is based on the technical specifications at the time of writing. **The manual covers all items of equipment (both standard and optional) available for these models, but whether or not these are fitted to the vehicle depends on the version, the options selected and the country where the vehicle is sold.**

This document may also contain information about items of equipment to be introduced later in the model year.

The diagrams in the user manual are provided as examples.

Enjoy driving your new vehicle.

Translated from French. Copying or translation, in part or in full, is forbidden unless prior written permission has been obtained from the car manufacturer.

CONTENTS

Welcome to your new electric vehicle.....	4	Driving	167
Exterior	4	Starting, stopping the engine	167
Passenger compartment	6	Gear control	170
Driver's position	8	Regenerative braking system	174
Driving aids	10	Parking brake.....	177
Safety on board	12	Environment.....	182
Identifying a vehicle - Labels	14	Driving advice, eco-driving	183
The engine compartment (routine maintenance).....	16	Tyre pressure loss warning.....	187
Breakdown recovery	18	Driver correction devices and aids	192
Getting to know your vehicle.....	20	Additional driving aid functions	196
Vehicle E-Tech 100% electric (EV)	20	Speed limiter	251
Card	52	Stop and Go adaptive cruise control	255
Digital key	60	Parking aids	272
Doors and opening elements.....	63	Emergency call	301
Facial recognition.....	74	Your comfort	304
Front seats.....	75	MULTI-SENSE	304
Rear seats	82	Air vents, heating and air conditioning.....	305
Seat belts.....	84	Multimedia equipment	317
Additional safety devices	88	Passenger compartment equipment.....	319
Child safety	97	Passenger compartment storage, fittings	324
Child seats	103	Transporting objects	330
Child safety: deactivating, activating the front passenger airbag.....	117	Maintenance	333
Driving position	120	Accessing the engine, levels	333
Trip computer.....	126	Battery	338
Warning lights	139	Cleaning.....	340
Steering	144	Practical advice.....	344
Rear view	146	Tyres	344
Lighting and signals	152	Breakdown recovery	353
Audible and visual signals	160	Headlights, lights: replacing bulbs	356
Wiper	161	Wiper blades: replacement	359

CONTENTS

Fuses	361
Important recommendations	365
Operating faults	367
Technical specifications	371
Information about the vehicle	371
Replacement parts and repairs	378
Service sheets	379
Anticorrosion check	385

EXTERIOR

1

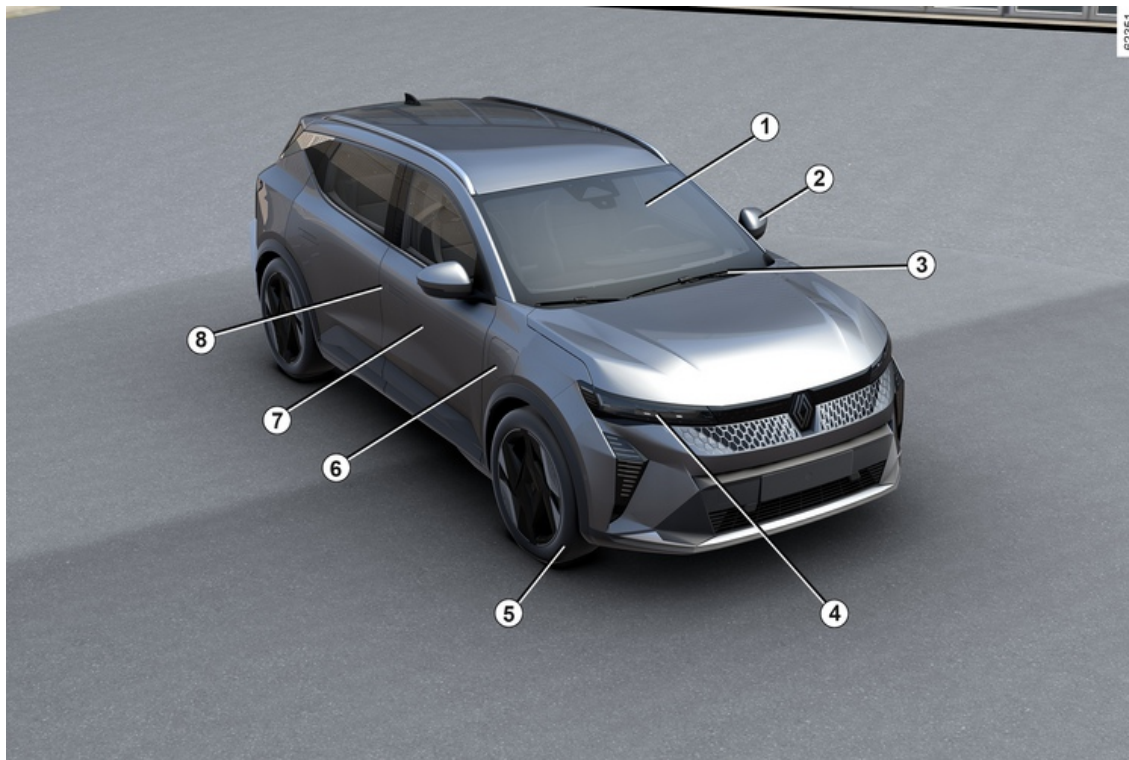

4 - Welcome to your new electric vehicle

EXTERIOR

1. Electric windows → 319
2. Rear view mirrors → 146
3. Screen wiper, washer → 161 → 164
Demisting → 312
4. Lights: operation → 152
Lights: replacement → 356
5. Tyres → 344
6. Load → 30
7. Bodywork maintenance → 340
8. → 52 card
Locking, unlocking the doors → 64

PASSENGER COMPARTMENT

1

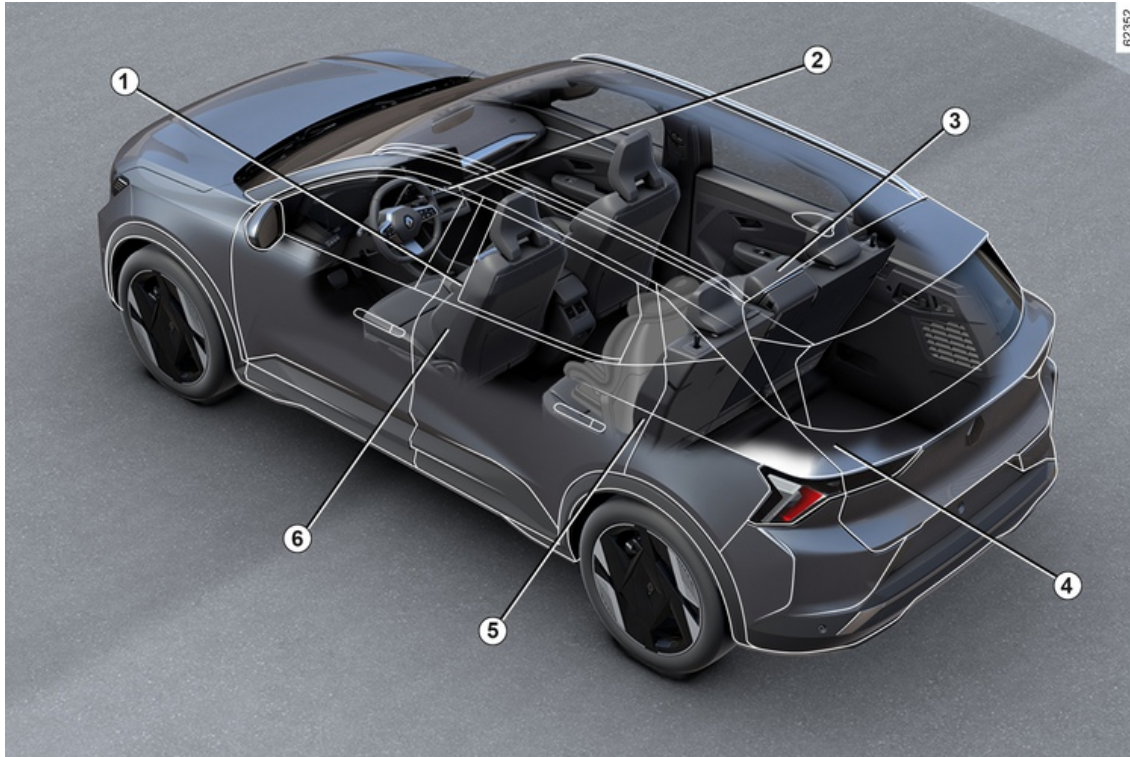

PASSENGER COMPARTMENT

1. Adjusting your driving position → **84**
2. Passenger compartment storage/fittings → **324**
3. Rear headrests → **82**
Rear bench seat → **82**
4. Transporting objects → **330**
5. Child safety → **97**
6. Front headrests → **75**
Front seats with manual controls → **75**
Front seats with electric controls → **77**

DRIVER'S POSITION

1

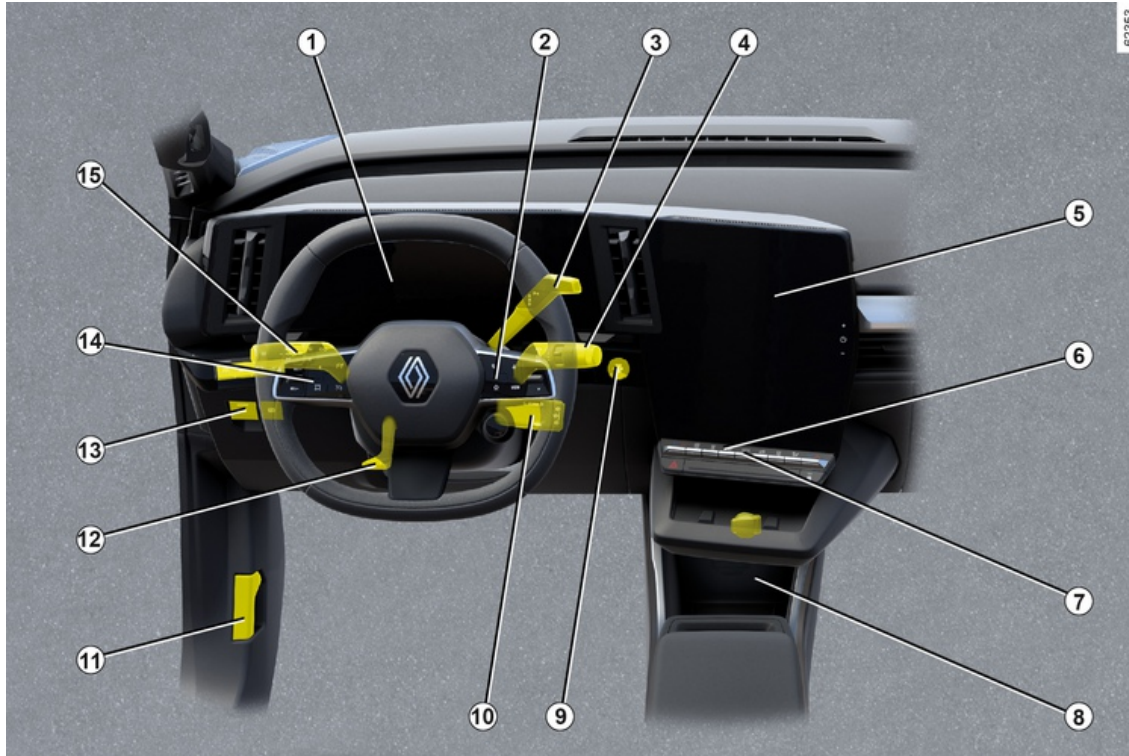

DRIVER'S POSITION

1. Instrument panel → 139
2. Trip computer controls → 126
3. Gear control → 170
4. Window wiper(s)/washer(s) control → 161 → 164
5. Multimedia screen → 317
6. Heated seat(s) → 75
7. Heating system/air conditioning → 309
8. Centre console storage compartment/induction charging zone → 324
9. Engine start/stop button → 167
10. MULTI-SENSE control → 304
11. Bonnet release → 333
12. Steering wheel adjustment → 144
13. Electronic parking brake → 177
14. Speed limiter → 251
15. Exterior lighting → 152

DRIVING AIDS

1

62354

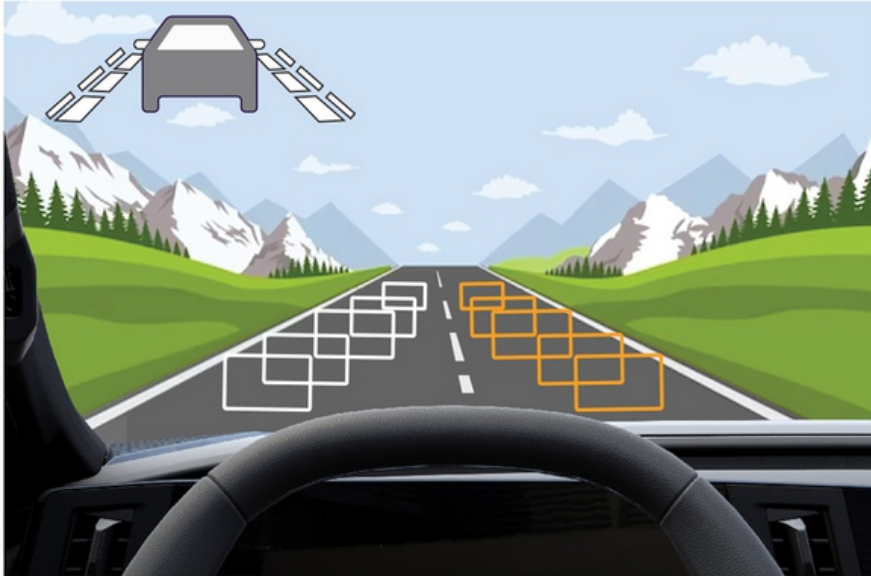

DRIVING AIDS

- Driver correction devices and aids → **192**
- Lane departure prevention → **197**
- Emergency lane departure prevention → **204**
- Active emergency braking → **220**
- Active emergency braking in reverse gear → **248**
- Blind spot warning → **211**
- Parking exit warning → **294**
- Tyre pressure loss warning → **187**
- Speed limiter → **251**
- Stop and Go adaptive cruise control → **255**
- Road sign detection → **229**
- Park Assist → **272**
- Reversing camera → **278**
- 360° camera → **286**
- Hands-free parking → **281**
- Safe vehicle exit → **297**
- Safe distance warning → **216**
- Driver vigilance warning → **227**

SAFETY ON BOARD

1

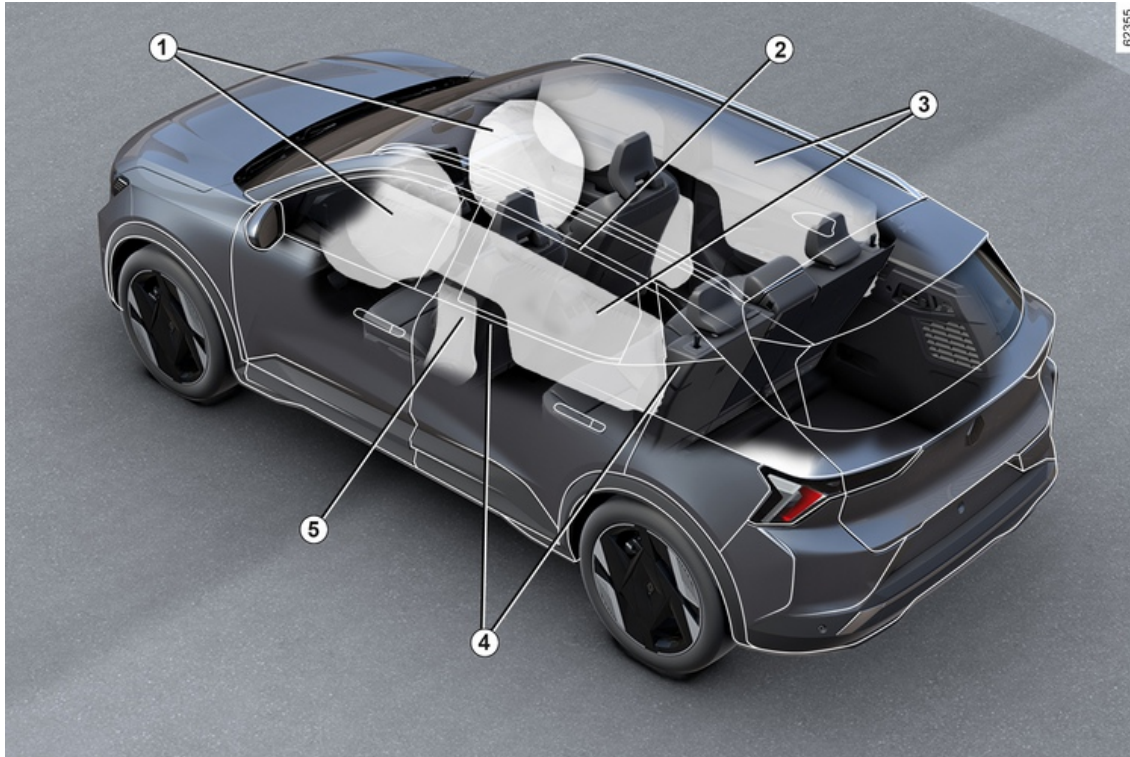

SAFETY ON BOARD

1. Front airbags → **89**
Deactivating the passenger's front airbag → **117**
2. Central airbag → **94**
3. Curtain air bags → **94**
4. Seat belts → **84**
5. Side air bags → **93**

IDENTIFYING A VEHICLE - LABELS

1

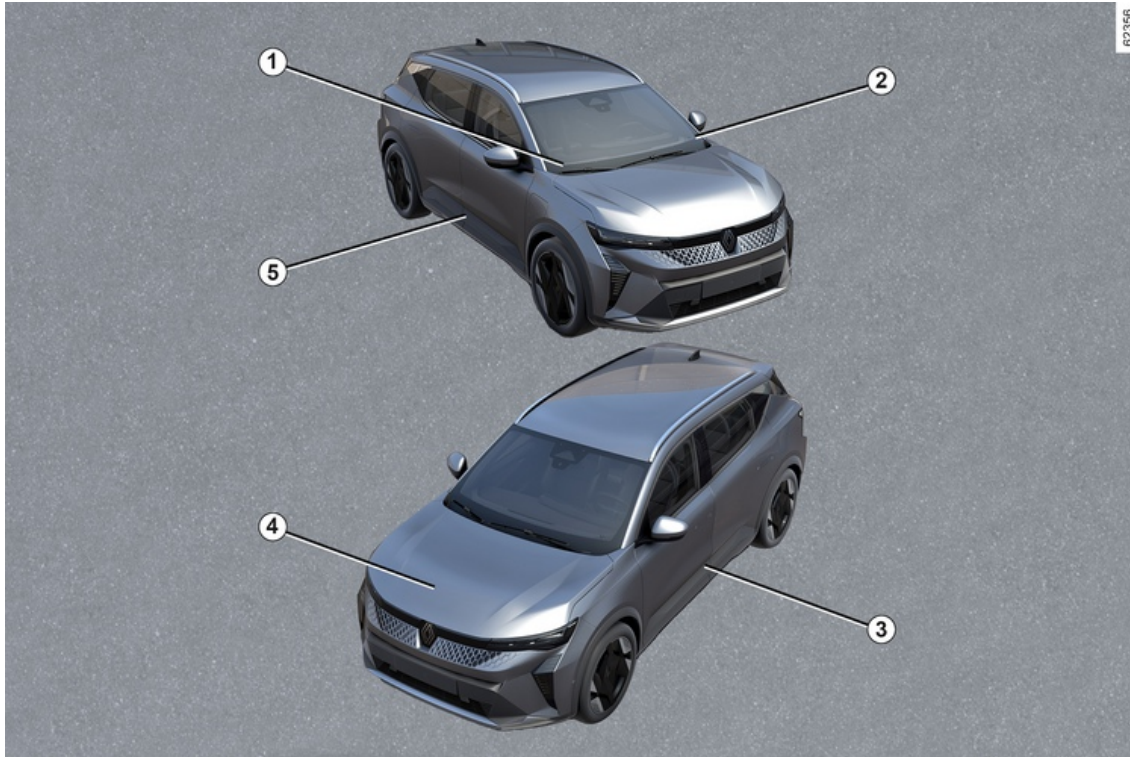

IDENTIFYING A VEHICLE - LABELS

1. Technical information for the emergency services → 371
2. Vehicle identification number reminder → 371
3. Tyre pressure labels → 187 → 344
4. Engine identification → 372
5. Vehicle identification plate → 371

THE ENGINE COMPARTMENT (ROUTINE MAINTENANCE)

1

02357

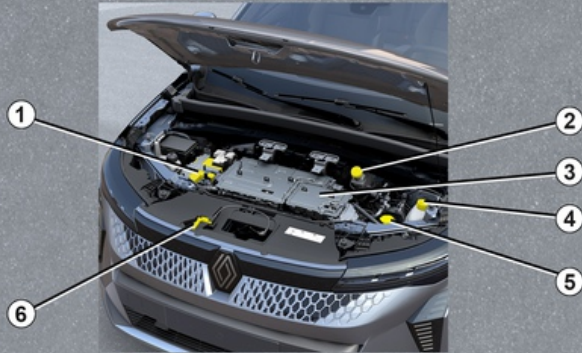

THE ENGINE COMPARTMENT (ROUTINE MAINTENANCE)

1. Battery → 338
2. Brake fluid → 336
3. “400 volt” electrical circuit → 20
4. Coolant → 335
5. Screen washer fluid → 337
6. Opening the bonnet → 333

BREAKDOWN RECOVERY

1

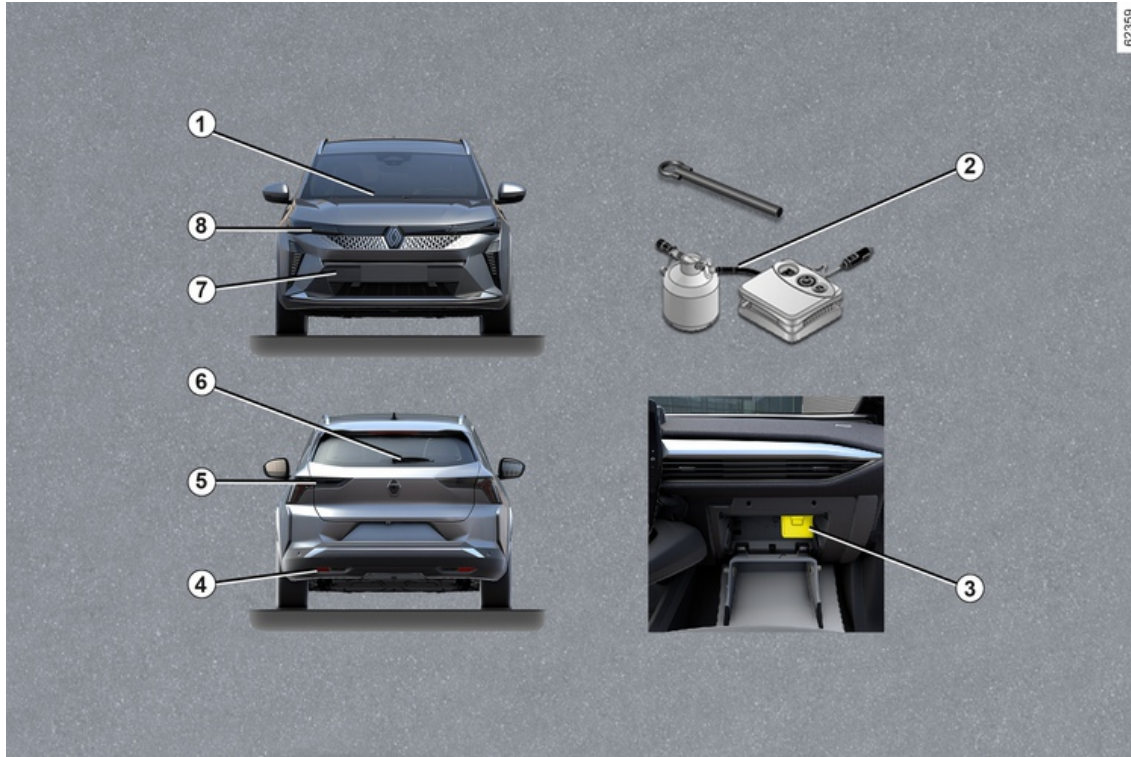

BREAKDOWN RECOVERY

1. Replacing windscreen wiper blade(s) → **359**
2. Puncture → **347**
Tools → **351**
3. Fuses → **361**
4. Rear towing point → **353**
5. Replacing rear light bulbs → **356**
- 6 Replacing the rear screen wiper blade → **359**
7. Front towing point → **353**
8. Replacing headlight bulbs → **356**

VEHICLE E-TECH 100% ELECTRIC (EV)

Electric vehicles have special features, but operate in a similar manner to conventional vehicles.

The main difference in electric vehicles is the exclusive use of electric energy instead of fuel, as used in convention vehicles.

We therefore recommend that you read these instructions describing your electric vehicle carefully.

2

VEHICLE E-TECH 100% ELECTRIC (EV)

Introduction

2 Electric vehicle schematic diagram

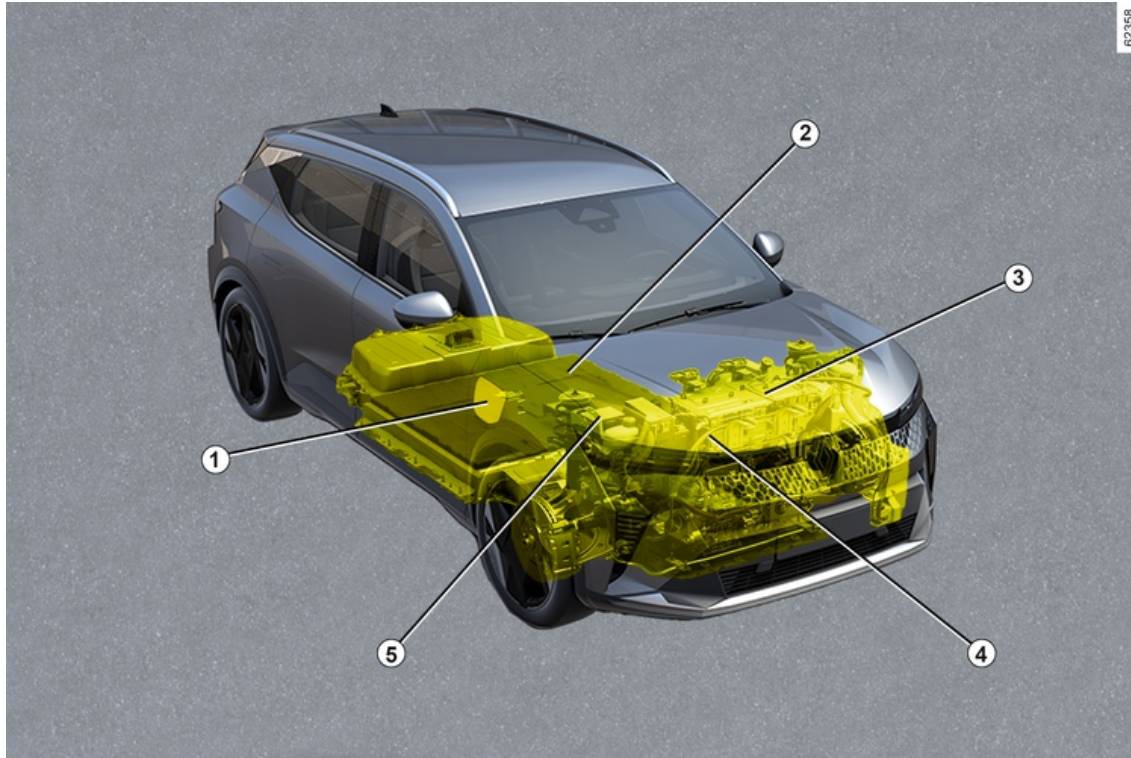

VEHICLE E-TECH 100% ELECTRIC (EV)

- 1 Electric charging connection (passenger side)
- 2 400 V traction battery
- 3 Electric motor
- 4 Orange electrical power cables
- 5 Secondary 12 V battery

VEHICLE E-TECH 100% ELECTRIC (EV)

Connected services

2

Introduction

Your electric vehicle has connected services that provide information and/or control:

- your vehicle's charging status with low battery warning;
- the traction battery charging programming, based on certain choices on offer;
- remaining vehicle range;
- ...

You can access these services using:

- external digital devices (mobile phone, tablet, etc.);
- the vehicle multimedia screen.

For more information, refer to the multimedia equipment instructions or contact an Approved Dealer.



You can subscribe to a connected service or extend it at any time by consulting an authorised dealer

Batteries

The electric vehicle has two types of battery:

- a "400 V" traction battery;
- secondary 12 V battery.

"400 V" traction battery

This battery stores the energy necessary to operate the motor in your electric vehicle properly. As with any battery, it discharges after use, and must be regularly recharged.

You do not have to wait until the traction battery hits the reserve level in order to recharge it.

Charging times vary depending on the type of specific wall unit socket or public terminal you connect to.

Your vehicle range will depend on the traction battery charge level and also on your driving style → **185**.

The vehicle's air conditioning system is used to cool the traction battery.

To preserve the lifetime of your traction battery, have your air conditioning system checked by a qualified professional. Especially if you notice a reduction in air conditioning performance.

Secondary 12 V battery

The second battery on your vehicle is a secondary 12 V battery: this supplies the energy required to operate vehicle equipment (lights, windscreen wipers, braking assistance, etc.).

(A)

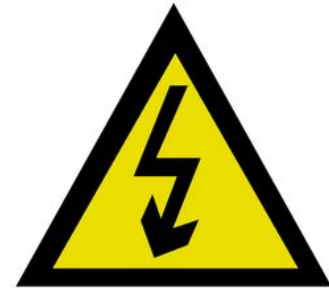

The **A** symbol identifies the electrical elements in your vehicle which may present safety risks.

VEHICLE E-TECH 100% ELECTRIC (EV)

"400 V" electrical circuit



The "400 V" electrical circuit can be recognised by orange cables **9** and

parts bearing the  symbol.



The vehicle drive system in an electric vehicle uses a direct voltage of approximately 400 volts.

This system can get hot during and after switching off the ignition. Respect warning messages given on the labels in the vehicle. All interventions or modifications to the 400V electrical system (components, cables, connectors, traction battery) are strictly prohibited due to the risks they present to your safety. Call an approved dealer.

The risk of serious burns or electric shocks can lead to death.

Driving

As with a car with an automatic gear-box, you will have to get used to not using your left foot, and not using this foot to brake.

When driving, if you lift your foot off the accelerator pedal or depress the brake pedal, the motor generates electrical current during deceleration and this energy is used to brake the vehicle and recharge the battery → **183**.

Bad weather, flooded roads:



Do not drive through floods if the depth of water is above the lower edge of the wheel rims.



The engine brake should under no circumstances be used as a substitute for the brake pedal.

Noise

Electric vehicles are particularly quiet. You will not yet necessarily be used to it, and neither will other road users. It is difficult for them to hear the vehicle when it is moving.

As the motor is silent, you will hear noises that you are not used to hearing (aerodynamic noises, tyre noise, etc.)

Each time the ignition is switched off, the ventilation will be switched off after about ten seconds.

VEHICLE E-TECH 100% ELECTRIC (EV)

2



Driver obstruction

On the driver's side, only use mats suitable for the vehicle, attached with the pre-fitted components, and check the fitting regularly. Do not lay one mat on top of another.

There is a risk of wedging the pedals



Your electric vehicle is silent. Before leaving it, with your foot on the brake, stop the engine.

RISK OF SERIOUS INJURY

Pedestrian horn

The pedestrian horn enables you to warn others of your presence – especially pedestrians and cyclists.

When the engine is started, the pedestrian horn is activated automatically. The sound is emitted when the vehicle speed is between approximately 1 and 19 mph (1 and 30 km/h).

For further information on the pedestrian horn, refer to the multimedia instructions.

In the event of a pedestrian horn mal-

function, the  warning light is illuminated on the instrument panel accompanied by the "Exterior sound fault" message.

Consult an approved dealer.

VEHICLE E-TECH 100% ELECTRIC (EV)

Important recommendations



Please read these instructions carefully. Failure to follow these instructions may lead to **a risk of fire, serious injury or electric shocks which could result in death.**

In the event of an accident or impact

In the event of an accident or an impact to the underside of the vehicle (e.g. striking a post, raised kerb or other street furniture) the electric circuit or the traction battery may be damaged.

Have the vehicle checked by an authorised dealer.

Never touch the "400 V" components or orange cables which are exposed and visible inside or outside the vehicle.

In the event of serious damage to the traction battery, leaks may occur:

- never touch liquids (fluids, etc.), coming from the traction battery;
- in the event of contact with the body, wash the affected area with plenty of water and consult a doctor as soon as possible.

In the event of an impact, even slight, against the charging flap and/or valve, have them checked by an authorised dealer as soon as possible.

In the event of fire

In the event of fire, make everyone evacuate the vehicle immediately and contact the emergency services, informing them that this is an electric vehicle.

If you have to intervene, only use ABC or BC extinguishing agents that are suitable for extinguishing fires on electrical systems. Do not use water or other extinguishing agents.

In the event of damage to the electrical circuit, please call an authorised dealer.

All towing operations

→ 353.

Washing the vehicle

Never wash the engine compartment, the charging connection or the traction battery with a high-pressure jet.

This risks damaging the electric circuit.

Never wash the vehicle while it is charging. Never wash the charging cable while the vehicle is charging. Never wash the charging cable and the charging cable plug while the cable is not connected, in order to prevent corrosion of the charging pins.

VEHICLE E-TECH 100% ELECTRIC (EV)

Risk of electric shock and a risk to life.

2

VEHICLE E-TECH 100% ELECTRIC (EV)

Charging

2

Schematic diagram

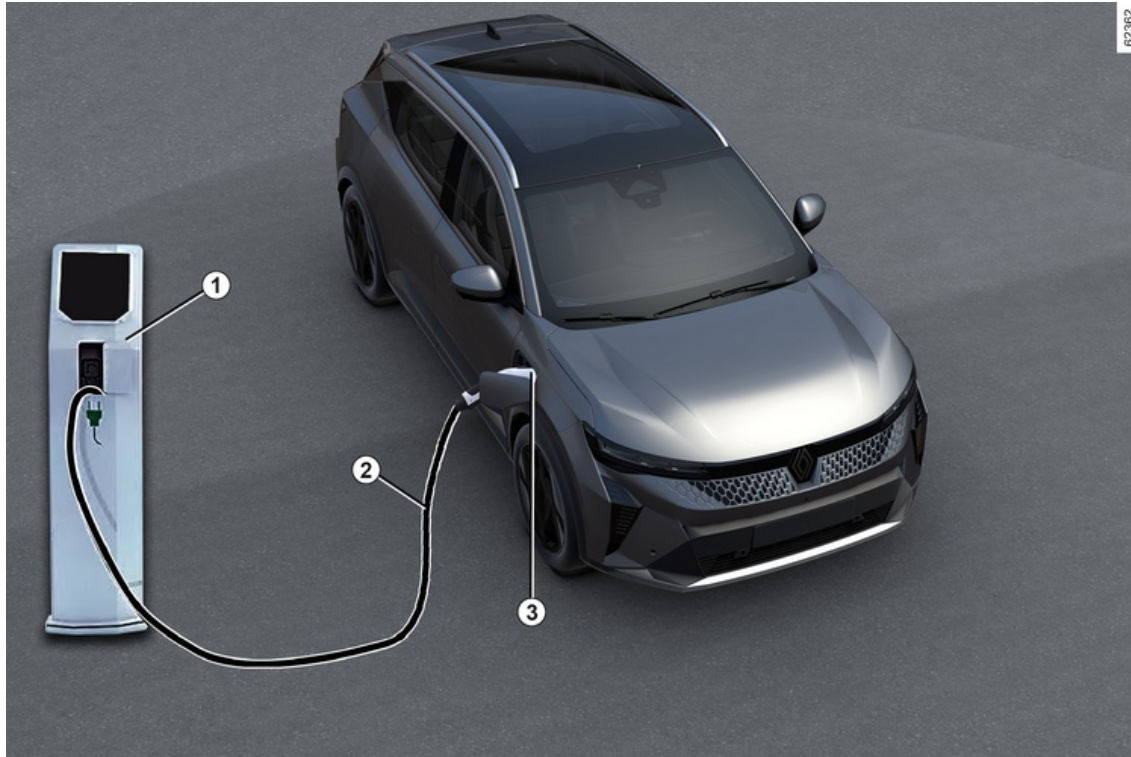

VEHICLE E-TECH 100% ELECTRIC (EV)

- 1 Specific wall socket or recharging terminal
- 2 Charging cable
- 3 Electric charging connection (passenger side)

2



If you have any questions regarding the equipment needed for charging, please ask an authorised dealer.



Important recommendations for charging your vehicle

Please read these instructions carefully. Failure to follow these instructions may lead to **a risk of fire, serious injury or electric shocks which could result in death.**

Charging

Do not do anything to the vehicle during charging (washing, working in the engine compartment, etc.).

In the event of the presence of water, signs of corrosion or foreign bodies in the charging cord connector or in the vehicle charging socket, do not charge the vehicle. Fire hazard.

Do not attempt to touch the cord contacts, the domestic socket or the vehicle charging socket, or introduce objects into them.

Never plug the charging cord into an adapter, multiple socket or extension lead.

The use of generators is prohibited.

Do not remove or change the vehicle charging socket or the charging cord. Fire hazard.

Do not modify or perform any action on the installation during charging.

In the event of an impact, even slight, against the charging flap or valve, have them checked by an authorised dealer as soon as possible.

Take care of the lead: do not tread on it, immerse it in water, pull on it or let anything knock against it.

Check regularly that the charging lead is in good condition.

In the event of damage to the charging lead (corrosion, browning, cuts, etc.), to the unit or to the vehicle's electrical charging socket, do not use them. Please see an authorised dealer to replace them.

In the event of non-activation of the charging flap locking mechanism and/or unlocking of the vehicle's electric charging socket, please contact an approved dealer.

VEHICLE E-TECH 100% ELECTRIC (EV)

Charging lead A

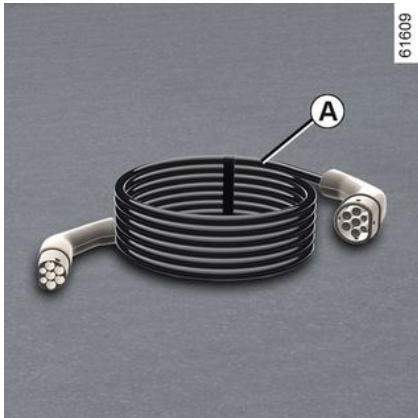

This lead is specific to your vehicle and designed for connecting to wall sockets or public terminals to enable standard charging of the traction battery.

i We recommend that you use a charging cord that enables a standard charge to charge the traction battery.

i Before cleaning the charging lead, make sure the lead is disconnected.

Clean the cable using a cloth slightly dampened with water. When cleaning, make sure that the cloth does not come into contact with the ends of the cable (connectors, charging pins) to avoid any risk of corrosion.

i Each charging lead is stored in the luggage compartment of the vehicle

→ 68.

Charging lead B

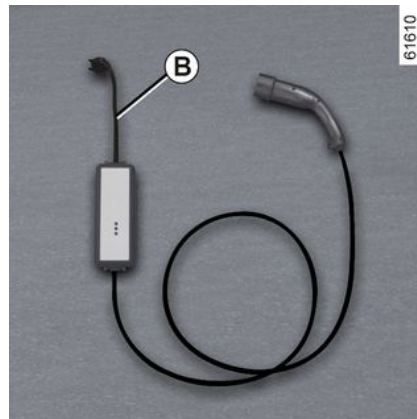

This lead can be used for:

- in normal use, on a socket used only for the vehicle (14 A/16 A charging);
- occasional charge using a domestic socket, (8 A charge) when you are not at home, for example.

In all cases, sockets must be fitted as stated in the instructions provided with the charging lead **B**.

VEHICLE E-TECH 100% ELECTRIC (EV)

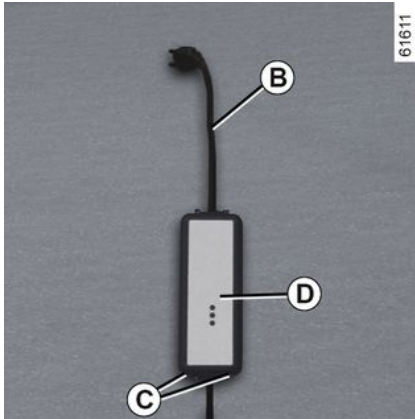

In all cases, read the charging lead **B** user instructions **carefully**.

i Never leave the socket hanging by the cord. Use the hooks **C** to hang it.

i If a malfunction occurs during the charging process (red warning light appears on the unit **D**), stop charging immediately. Please refer to cord instructions.

VEHICLE E-TECH 100% ELECTRIC (EV)

Important recommendations

2



Important recommendations for charging your vehicle

Please read these instructions carefully. Failure to follow these instructions may lead to **a risk of fire, serious injury or electric shocks which could result in death.**

Choice of charging cord

The standard charging cords supplied with the vehicle have been designed specifically for this vehicle. It is designed to protect you against the risks of electric shock that can lead to death or fire.

Do not use with the charging leads of previous vehicles as they are not adapted.

For safety reasons, the use of a charging cord not recommended by the manufacturer is strictly forbidden. Failure to follow this instruction can lead to risks of fire or electric shock that can prove fatal. For information on a charging cord suited to your vehicle, please consult an authorised dealer.

Using the charging lead *B*

Please read the instructions that come with the charging lead carefully to learn about the precautions you must take when using the product and the technical specifications required for fitting the socket.

Installation

Wall socket

Have a special wall socket installed by a qualified professional.

In the case of domestic charging

Have a qualified professional check that each socket to which you will connect the charging cable complies with the standards and regulations in force in your country and that it complies with the specifications described in the information on "Power supply systems".

Power supply systems

Only use charging terminals which conform to the IEC 61851-1 standard and connecting points protected by:

- a Type A 30 mA residual current device specific to the socket used;
- an overcurrent protection device;
- protection against overvoltage relating to lightning in exposed areas (IEC 62305-4);
- an earth connection that complies with the standards in the relevant country.

VEHICLE E-TECH 100% ELECTRIC (EV)

Charging types that conform to European standards

2

VEHICLE E-TECH 100% ELECTRIC (EV)

Alternating current (AC)

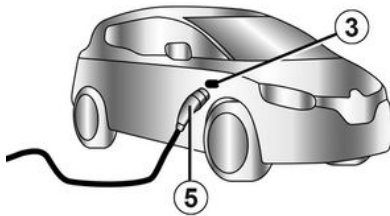
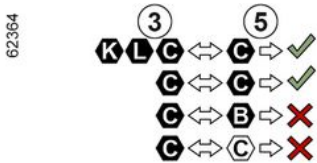
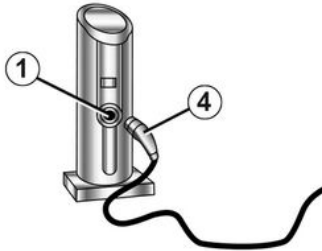

If the information is displayed on the vehicle charging flap, follow the instructions below.





Before plugging in a charging lead, check that:

- the colour and one of the letters of the input socket **1** correspond to the colour and one of the letters on the end **4** of the lead;
- the colour and one of the letters of the input socket **3** correspond to the colour and one of the letters on the end **5** of the lead.

VEHICLE E-TECH 100% ELECTRIC (EV)

Labels

2

Charging type	Alternating current (AC)			
Connection	Charging terminal 1/Charging cable 4		Vehicle 3/Charging cable 5	
Charging types that conform to European standards (for all other cases, please consult an approved dealer).				

VEHICLE E-TECH 100% ELECTRIC (EV)

Direct current (DC)

2

62378

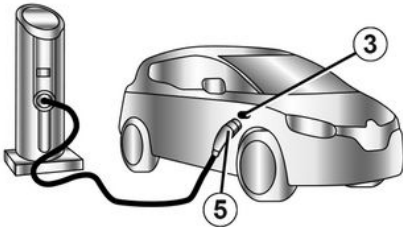
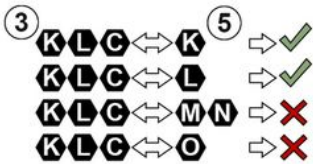





If the information is displayed on the vehicle charging flap, follow the instructions below.

Before plugging in a charging lead, make sure that the colour and one of the letters on the inlet socket **3** correspond to the colour and one of the letters on the end **5** of the charging lead.

VEHICLE E-TECH 100% ELECTRIC (EV)

Labels

Charging type	Direct current (DC)				
Connection	Vehicle 3/Charging cable 5				
Charging types that conform to European standards (for all other cases, please consult an approved dealer).					

2

VEHICLE E-TECH 100% ELECTRIC (EV)

Electric charging socket 3

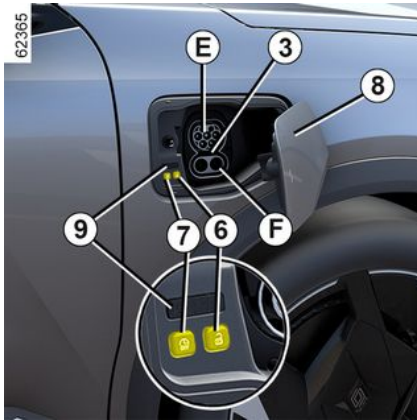

Note: if in a snowy environment, remove snow from the vehicle charging area on the passenger side before plugging in or disconnecting.

Snow in the socket may block the insertion of the charging cord plug.

The vehicle is equipped with two charging connections located on the passenger side at the front of the vehicle:

- socket **E** for charging up to 22 kW;
- socket **F** for rapid charging (depending on the vehicle).

There are also two buttons located inside the charging flap:

– the  button **6** unlocks the charging cable;

– The  button **7** launches immediate charging of the vehicle;

Precautions

For daily use, it is recommended that you charge your vehicle to 80% to improve the battery service life.

Avoid charging and parking your vehicle in extreme temperatures (hot or cold).

Under extreme conditions, charging may take several minutes before starting (time required for the traction battery to cool down or warm up).

When the vehicle is parked for more than seven days in temperatures below approximately -25°C , charging the traction battery can become impossible.

When the vehicle is parked for more than three months with near zero charge, charging the battery can become impossible.

The energy level available depends on the battery temperature. It may therefore vary between stopping and restarting the vehicle if the battery is cold or warm.

To preserve the service life of your traction battery, avoid parking the vehi-

cle for more than one month with high charge, especially when the weather is very hot.

Favour charging the traction battery after driving and/or in mild temperatures. Otherwise, charging may take a longer period of time or even become impossible.

It is preferable to recharge the vehicle after driving if the charge level is low ($< 25\%$) and in negative temperatures.

Advice

- In high temperatures, try to park and recharge the vehicle in a shaded/sheltered location;
- charging can be performed in the rain or snow;
- activating the air-conditioning increases the charging time required.

Recharging the traction battery

Vehicle stationary, ignition off:

- take the charging cable **2** located in the storage compartment in your vehicle's luggage compartment;
- press the charging flap **8** to unlock it. The warning light **9** illuminates in white;

VEHICLE E-TECH 100% ELECTRIC (EV)

 Depending on the vehicle, when the charging flap is open or not properly closed, the "Charging flap open" message appears on the instrument panel.

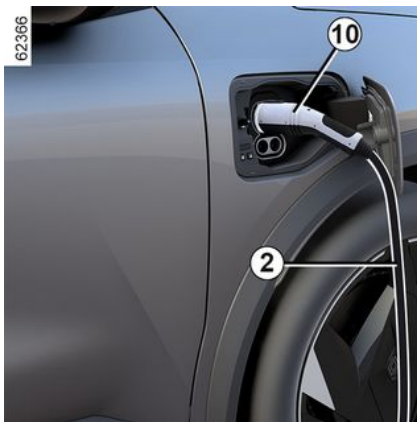

- plug in the end of the lead to the power supply;
- grab the handle **10**;
- plug in the vehicle cord. The warning light **9** flashes in yellow;

 Do not use the charging flap **8** to hang the charging lead **2** while recharging the vehicle.

 If you have just accepted a system update via the multimedia system, the traction battery charging will be delayed or cancelled. Wait for the update to be completed before connecting the charging lead to the vehicle. For more information on system updates, please refer to the multimedia instructions.

- after you hear a locking click, check that the charging cord is properly plugged in. To check the locking, pull gently on the handle **10**;
- if you have programmed a deferred charge and you wish to start charging immediately, press the button **7** to start charging → **313**.

The charging cord is automatically locked with the vehicle. This will make it impossible to unplug the cord from your vehicle.

 If fast-charging the vehicle (DC), the charging cable between your vehicle and the charging terminal must not exceed **30 metres**. If in doubt about the length of the cable, consult the owner of the charging terminal (DC).

 Make sure you fully uncoil the charging cord to limit its heating.

 Do not use an extension lead, multiple socket or adapter.
Fire hazard.

During charging, the warning light **9** flashes in blue.

When charging starts, the following information is displayed on the instrument panel:

- the energy level on the battery warning light **12**;

VEHICLE E-TECH 100% ELECTRIC (EV)

2

 The traction battery charging time depends on the amount of energy remaining and the power delivered by the charging terminal. The information is displayed on the instrument panel during charging → 133.

Note: under certain conditions, the actual charging time may be longer than the charging time displayed on the instrument panel. This depends on:

- the quality of the electrical network;
- the initial charge level;
- the exterior temperature is too cold;
- ...

In the event of a problem with the charging cable, we recommend that you replace it with a cable that is identical to the original. Consult an approved Dealer.

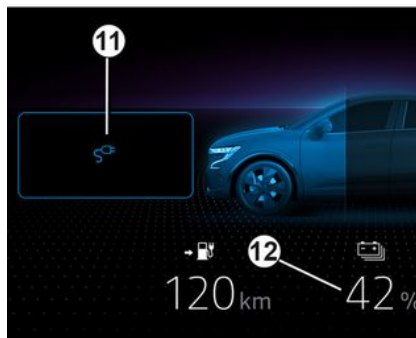

- the battery refill rate;
- an estimate of the remaining charging time (this is not displayed after the battery is charged to approximately 95%);
- the warning light **11** indicates that the vehicle is connected to a power supply;
- your vehicle range will vary according to the charge level.

The display on the instrument panel disappears after a few seconds. It reappears on the instrument panel when a door is opened.

Once charging is complete, the warning light **9** illuminates continuously in green.

You do not need to wait until the charge is at reserve levels to recharge your vehicle.

Operating faults

If the warning light **9** is illuminated continuously in red, please contact an approved dealer.

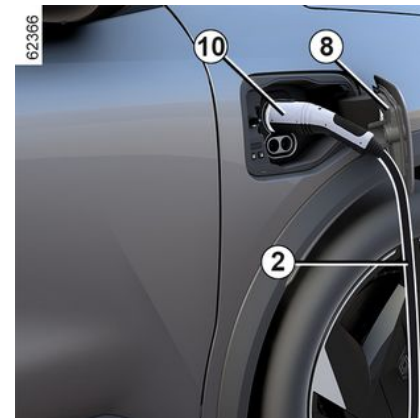

Precautions to take when removing from the socket

- Press the button **6** or **press and hold** the door unlocking button on the card in order to release the vehicle charging lead;
- grab the handle **10**;

VEHICLE E-TECH 100% ELECTRIC (EV)



It is imperative to follow the unplugging steps in order.

- unplug the charging lead **2** from the vehicle;
- you must close the charging flap **8** and press on it to lock it;
- disconnect the lead **2** from the power supply **1**;
- store the lead **2** in the storage compartment of your luggage compartment.

Note: immediately after a long period of charging the traction battery, the lead may be hot. Please use the handles.



After pressing the charging cable release button, you will have around 30 seconds to unplug it before it is locked once again.

Label 13

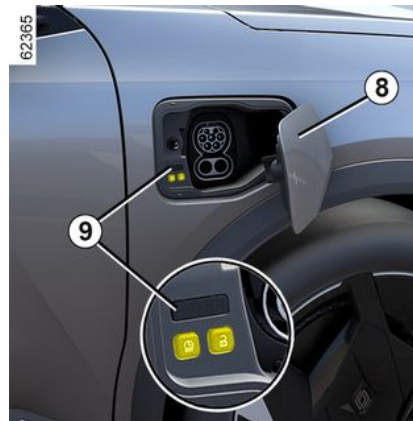

The label **13** located on the charging flap **8** provides information on the charging operation according to the status of the warning light **9**:

- when it flashes in white this indicates that the lead is plugged into the vehicle and the system is carrying out its checks;
- when it lights up continuously in blue this indicates that charging programming is activated;
- when it flashes in blue this indicates that charging is in progress;
- when it lights up continuously in green this indicates that the vehicle is fully charged;

- flashes in green: when Vehicle to Grid (V2G) → **47** or Vehicle to Load (V2L) → **47** is enabled;
- when it lights up continuously in red this indicates an operating fault.

61903

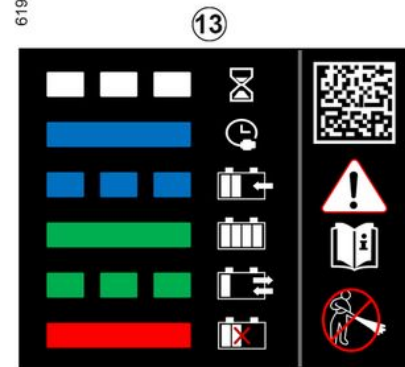

The label **13** located on the right-hand side reminds you of the following instructions:

- do not wash the charging flap using a high-pressure water jet;
- with the vehicle stationary, the valve and the charging flap can be opened;
- when the vehicle is being driven, the valve and the charging flap must be closed;
- open the flap to connect the charging lead;

VEHICLE E-TECH 100% ELECTRIC (EV)

- close the flap again once disconnected;
- connect to a domestic socket, an alternating current charging terminal or a quick charging terminal;
- for any information on charging, please consult your vehicle user manual.

Charging programming



With the vehicle stationary and the engine running, from the "Vehicle" world **2** on the multimedia screen **1**, press the "Electric" menu **3** to programme the charging and/or comfort of your vehicle.

You can use the "Programmes" tab to:

- add a new charging programme;
- or
- access pre-saved charging programmes.

Please refer to the multimedia instructions for further information.



For safety reasons, carry out these operations when the vehicle is stationary.

When the programming is confirmed,

the indicator light  lights up on the instrument panel.

Note: charging will start if the engine is switched off, the vehicle is connected to a power supply and access is authorised.



If you have just accepted a system update via the multimedia system, the traction battery charging will be delayed or cancelled.

Wait for the update to be completed before connecting the charging lead to the vehicle.

For more information on system updates, please refer to the multimedia instructions.

VEHICLE E-TECH 100% ELECTRIC (EV)

Vehicle to Grid (V2G) charging

Depending on the vehicle, with the vehicle stationary and connected using your vehicle's charging cable, the Vehicle to Grid (V2G) charging allows you to redistribute the energy stored in your vehicle's battery to your home and to the power grid.

You must have a compatible two-way AC charging terminal and have subscribed to the V2G charging service. Please refer to the multimedia instructions for further information.



Disconnect your vehicle before carrying out any work or modification on the electrical installation.



To set up V2G charging, refer to the multimedia user manual.

Vehicle to Load (V2L) function

With the vehicle stationary and the parking brake applied, the "Vehicle to Load" (V2L) function allows you to connect electrical devices directly to the vehicle.

The system provides AC power (up to 16 A/3.7 kW) using electrical energy stored in your vehicle's traction battery → 20.

The V2L connector enables you to connect and operate various electrical devices using the charging socket at the front of your vehicle.

Important recommendations



Please read these instructions carefully. Failure to follow these instructions may lead to a

risk of fire, serious injury or electric shocks which could result in death.

Precautions to be taken when using the V2L function.

Do not attempt to power your home as this can lead to damage and electric shocks.

Do not wash the vehicle or work in the engine compartment while using the V2L function.

Do not use the V2L function:

- if there is water in the V2L connector or in the vehicle's charging socket;
- if the vehicle's V2L connector or charging input socket is damaged (broken, signs of corrosion, discolouring, etc.), contact an approved dealer to organise a replacement;
- outdoors, if the weather conditions are unsuitable (rain, risk of lightning, etc.).

VEHICLE E-TECH 100% ELECTRIC (EV)

2

Do not place metal objects on the V2L connector.

Do not modify or interfere with the V2L connector while using the V2L function.

Never connect an adapter to the V2L connector.

Precautions to be taken when handling and using the V2L connector.

Use only the V2L connector supplied with the vehicle. The V2L connector has been designed specifically for this vehicle. For your safety, the use of a V2L connector not recommended by the manufacturer is strictly prohibited. For more information on which V2L connector is right for your vehicle, consult an approved dealer. Do not rest any objects against the V2L connector and do not hang devices by their power cable from the AC output socket of the V2L connector. **Risk of damage.**

Take care of the V2L connector. Do not disassemble it, immerse it in water or pull on it while it is connected and do not let anything knock against it. Regularly check the condition of the connector before use.

Precautions to be taken when using electrical/electronic devices.

Before plugging in and using a device (extension cable, multi-plugs, etc.), check the precautions for use by referring to its user manual.

Do not plug in:

- devices that require a direct current, such as medical equipment. The power supply may be interrupted depending on the vehicle operating conditions;
- devices that consume more than 16 A;
- devices that do not comply with national regulations and standards;
- damaged devices (units, cables, etc.);

- devices whose initial recommendations for use are not adapted to the environment in which they will be used (risks related to contact with dust and water);
 - more than one multi-plug.
- When in use, do not connect products that consume more than 8 A;
- an extension lead more than 20 m long. If used, be sure to unwind it completely.

Vehicle to Load (VLC) connector A

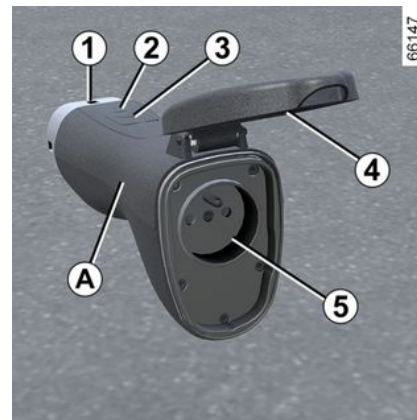

1 Charging socket;

VEHICLE E-TECH 100% ELECTRIC (EV)

- 2 Operation warning light;
- 3 On/Off switch;
- 4 Protective cover;
- 5 AC output socket.

The V2L connector is stored in the toolkit located underneath the luggage compartment carpet.

i Before carrying out maintenance on the V2L connector, make sure the connector is disconnected.

Clean the connector using a cloth slightly dampened with water. When cleaning, make sure that the cloth does not come into contact with the ends of the connector (connectors, charging pins) to avoid any risk of corrosion.

Operation



Ensure that the parking brake is always applied when the V2L function is in use.

i You must observe the order in which the V2L connector is connected/disconnected.

i Before connecting or disconnecting a device, make sure that the V2L connector indicator light **2** is off.

To connect the V2L connector

With the vehicle stationary, the opening elements unlocked and the ignition off:

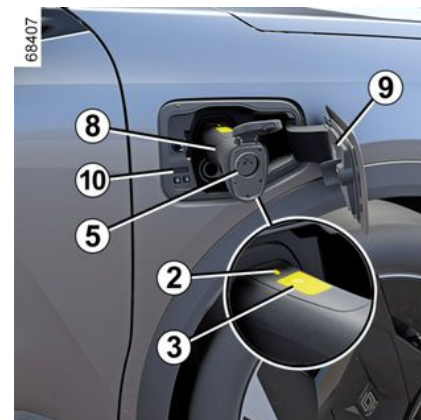
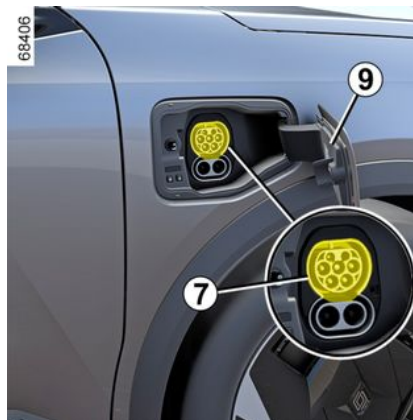

- press the charging flap **9** to unlock it;
- hold the handle of the connector **8** and connect the end piece **1** of the connector to the vehicle charging socket **7**;
- check that the V2L connector is correctly connected by pulling lightly on the handle **8**. Before the discharge begins, the socket lock is activated. The V2L connector is automatically locked to the vehicle. This makes it impossible to disconnect the connector from the vehicle;
- connect the electrical device to the V2L connector AC output socket **5**;
- press the V2L connector switch **3** for at least three seconds until the indicator light **2** appears in green. The V2L

VEHICLE E-TECH 100% ELECTRIC (EV)

function is activated, the indicator light on the charging socket **10** flashes in green and the electrical device is supplied with power.

Note: do not pull the handle **8** while the V2L connector is being locked to the vehicle.



When in use, the following information is displayed on the instrument panel:

- the indicator light **11** to indicate that the vehicle is connected to the V2L connector;
- the estimated time **12** remaining before the minimum battery charging threshold is reached;
- the battery energy level **13**.

Note: the power supply automatically shuts off when:

- the V2L function is not used for about an hour (no electrical devices connected to the AC socket **5** of the V2L connector or no power consumption);

- an electrical device exceeding the maximum power capacity is connected;
- the opening elements have been previously locked, the driver's door is unlocked;
- the minimum charging threshold of the traction battery set from the multimedia display is reached.

When the power supply is cut off, a message will appear on the instrument panel to inform you.

To disconnect the V2L connector

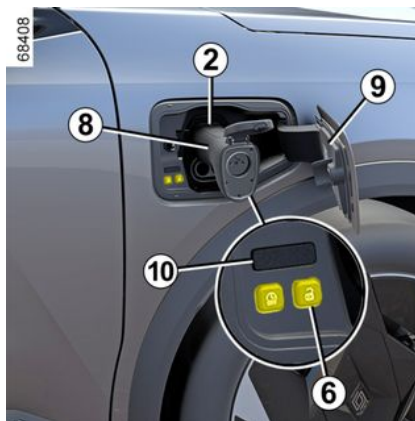

With the card on you or the vehicle opening elements unlocked:

- press the button **6**  located next to the charging socket to stop the

- discharging. The indicator light **2** goes out, the indicator light on the charging socket **10** goes out and the V2L function is deactivated;
- the V2L connector is automatically unlocked with the vehicle. This enables the connector to be disconnected from your vehicle;
- disconnect your electrical device and hold the handle **8** of the V2L connector to disconnect it from the vehicle **within approximately 15 seconds**. Otherwise, the charging socket **7** will be locked again automatically;
- close the charging flap **9** and press on it to lock it;
- place the V2L connector in its storage area.

 Do not drive the vehicle while the charging flap **9** is open. Once the V2L connector is disconnected from the vehicle, make sure that the charging flap **9** is properly closed.

VEHICLE E-TECH 100% ELECTRIC (EV)

Settings



You can set the minimum charge threshold level of the traction battery from the multimedia screen **14**.

Please refer to the multimedia instructions for further information.

Operating faults

In the event of an operating malfunction, the indicator light **2** on the V2L connector will go out and the V2L (discharge) power supply will switch off automatically. A message is displayed on the instrument panel to inform you.

In the event of an internal failure of the V2L function, the "V2L discharge impossible V2L to check" message will

be displayed on the instrument panel: disconnect the electrical device and disconnect the V2L connector. Consult an approved Dealer.

In the event of a failure of the V2L function from the device connected to the AC socket of the V2L connector, the "V2L discharge impossible Connected device fault" message is displayed on the instrument panel:

- disconnect the electrical device and the V2L connector;
- check that the device and V2L connector are not damaged and that the power supply plug is not broken or corroded;
- make sure that the electrical device does not exceed the maximum capacity of power that the vehicle can provide.

If there is still a problem, contact an approved dealer.

CARD

General information

2

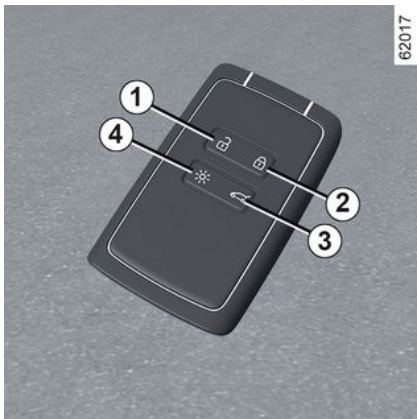

1. Unlocking the doors and luggage compartment.
2. Locks all the opening elements.
3. Unlocking/locking the boot.
4. Switching on the lighting remotely.

The card is used for:

- locking/unlocking the opening elements (doors, luggage compartment door) and folding out or folding in the front door handles;
- unlocking the charging flap → 20;
- switching on the vehicle lighting remotely;

- automatically closing the electric windows remotely → 64;
- automatically opening the electric windows remotely → 64.

 Depending on the vehicle, you may have a digital key that offers all the functions of the card. However, if a card has been left inside the vehicle and the doors have been locked with a digital key, all of the card's functions will be inhibited. For further information, please see the "Digital key" section → 60.

Range

Make sure that the correct battery type is being used, and that the battery is in good condition and inserted correctly. Its service life is approximately two years: it should be replaced when the "Keycard Battery Low" message appears on the instrument panel → 54.

card operating range

This varies according to the surroundings: take care not to accidentally lock or unlock the vehicle by inadvertently pressing the buttons on the card.

Note: if a door or the luggage compartment door is open or not properly shut, the vehicle will not be locked. A beep sounds and the hazard warning lights and side repeaters do not flash.

 If the battery is flat, you can still lock/unlock and start your vehicle → 167 → 64 → 52.

"Remote lighting" function

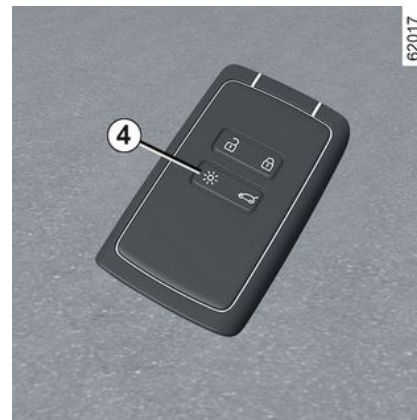

Press button 4 to switch on the dipped beam headlights and the exterior lighting for approximately 20 seconds. This can be used, for example, to identify

CARD

the vehicle from a distance when parked in a car park. Press and hold button **4** for approximately two seconds to switch on the exterior lighting and emit a sound.

Note: press button **4** again to switch off the lighting.

Recommendations

Avoid leaving the card in hot, cold or humid areas.

Do not keep the card in a place where it could be bent or damaged accidentally, such as in a back pocket of a garment where it might be sat on.

Replacement: need for an additional card

If you lose your card or require another, you can obtain one from an approved dealer.

If a card is replaced, it will be necessary to take the vehicle **and all its cards** to an approved Dealer to initialise the system.

You may use up to four cards per vehicle.

Interference

Interference by factors in the immediate vicinity (external installations or the use of equipment operating on the same frequency as the remote control) may affect the operation of the remote control.



Driver's responsibility when parking or stopping the vehicle

Never leave an animal, child or adult who is not self-sufficient alone in your vehicle, even for a short time.

They may pose a risk to themselves or to others by starting the engine, activating equipment such as the electric windows or locking the doors.

Also, in hot and/or sunny weather, please remember that the temperature inside the passenger compartment increases very quickly.

RISK OF DEATH OR SERIOUS INJURY.

Fitting a hand strap 7

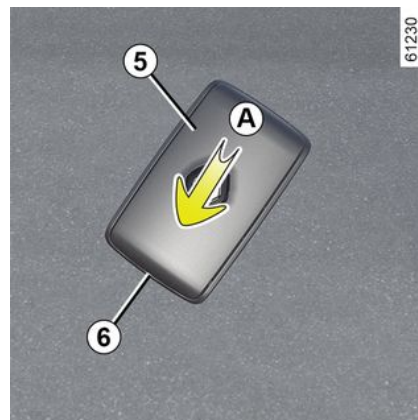

Slide the rear casing **5** downwards while pressing on area **A**.

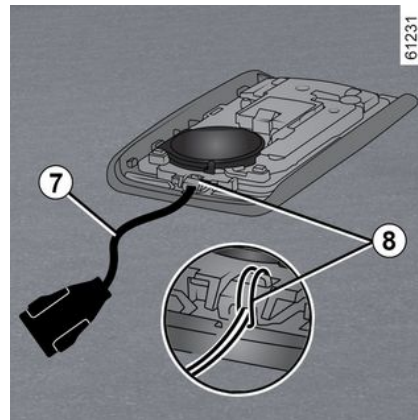

CARD

Insert the hand strap into the component **8** and pass the end of the strap through the buckle.

Position the strap at the opening **6** and close the casing.

Note: check that the diameter of the hand strap cord **7** fits the opening **6**.

Card

Use



There are two ways to unlock/lock the vehicle:

- in "hands-free" mode, when approaching and moving away from the vehicle;
- using the card in remote control mode.



Do not store the card anywhere it may come into contact with other electronic equipment (computer, phone etc.) as this could hinder its operation.

Deactivating/activating the "hands-free" mode

Depending on the vehicle, you can deactivate/activate unlocking when approaching and locking when moving away from the vehicle.

You can also deactivate/activate the sound signal that is emitted upon locking when moving away from the vehicle → 136.



Never leave your vehicle with the card inside.



Driver's responsibility when parking or stopping the vehicle

Never leave an animal, child or adult who is not self-sufficient alone in your vehicle, even for a short time.

They may pose a risk to themselves or to others by starting the engine, activating equipment such as the electric windows or locking the doors.

Also, in hot and/or sunny weather, please remember that the temperature inside the passenger compartment increases very quickly.

RISK OF DEATH OR SERIOUS INJURY.

CARD

"Hands-free" unlocking when approaching the vehicle

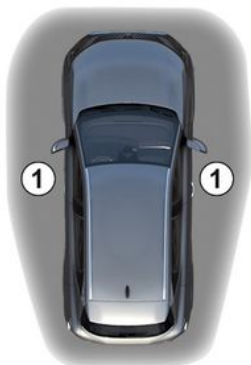

62369

With the card in the access zone **1**, the vehicle will be unlocked. The front handles are folded out and the hazard lights and side repeaters **flash once** to indicate that the doors have unlocked and, on some vehicles, the door mirrors fold out automatically.

"Hands-free" locking when moving away from the vehicle



62370

With the card on you and the doors and luggage compartment door closed, move away from the vehicle: it will be locked automatically as soon as you leave the access zone **1**. The front handles are folded in and the hazard lights **flash twice then remain illuminated** for about four seconds, then a beep sounds to indicate that the doors have locked and, on some vehicles, the door mirrors fold in automatically.

Note: the distance at which the vehicle locks depends on the surroundings.

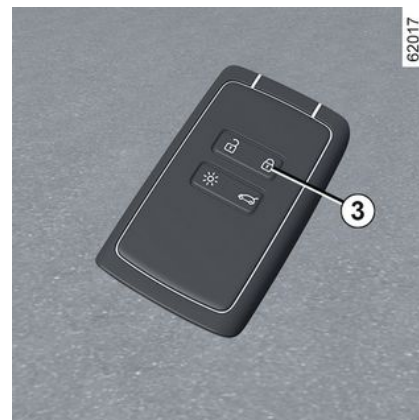

62017

2

If the card has been within the detection zone **1** for approximately 15 minutes, remote locking is deactivated. To lock the vehicle, press the button **3** on the card.

The vehicle cannot be remotely locked if the card is within the zone **2**.

CARD

"Hands-free" unlocking by opening the luggage compartment



With the card in the zone **1** and the vehicle locked, press button **4** once to unlock the entire vehicle.

The front handles are folded out and the side indicator lights and hazard warning lights **flash once** to indicate that the doors have unlocked.

Special features of the unlocking system

Under certain circumstances, unlocking when approaching the vehicle is deactivated:

- if the vehicle has not been used for eight days;

- if the card remains close to vehicle zone **1** during approximately five minutes **after the vehicle has been locked**;
- after several passes in the vicinity of zone **1** **without the doors having been unlocked**.

Press the luggage compartment door opening button **4** or use the card as a remote control to unlock the vehicle and reactivate "hands-free" mode.

Special features relating to "hands-free" locking

After locking in "hands-free" mode, you have to wait approximately three seconds to be able to unlock the vehicle again. During these three seconds, the door handles can be tried to make sure that the vehicle is locked properly.

Note: if a door or the luggage compartment door is open or not properly shut, the vehicle will not be locked. A beep sounds but the hazard warning lights and side repeaters do not flash.

Using the card as a remote control

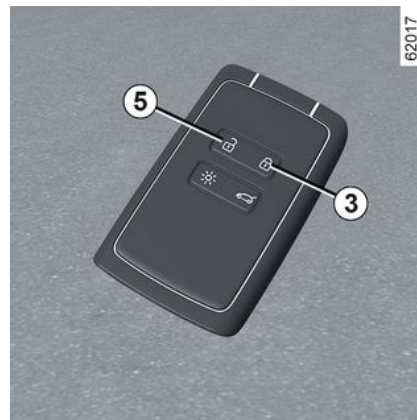

Unlocking with the card

Press the button **5**.

The front handles are folded out and the side indicator lights and hazard warning lights **flash once** to indicate that the doors have unlocked.



The card buttons are deactivated when the engine is running.

Locking using the card

With the doors and luggage compartment door closed, press button **3**: the vehicle will be locked.

CARD

The front handles fold in and the hazard lights and side repeaters **flash twice** to indicate that the doors have locked and, on some vehicles, the door mirrors fold in automatically.

Depending on the vehicle, press button **3** twice to lock the vehicle. Press and hold button **3** to close the front and rear windows.

Note:

- the maximum distance at which the vehicle locks depends on the surroundings;
- if a door or the boot is open or not properly shut, locking is not carried out. A beep sounds but the hazard warning lights and side repeaters do not flash.



62370

While the engine is running, if the card is no longer in zone **2** after a door is opened and closed, the "Keycard Not Detected" message indicates that the card is no longer inside the vehicle. This will, for example, prevent you from driving away after dropping off a passenger who has kept the card on them.

The warning disappears when the card is detected again.

Locking/unlocking the boot only

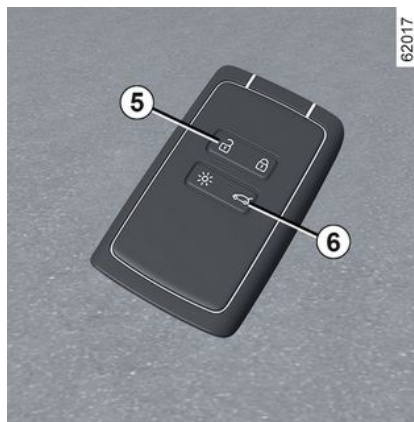

62017

Press button **6** to lock/unlock the luggage compartment only.



Driver's responsibility when parking or stopping the vehicle

Never leave an animal, child or adult who is not self-sufficient alone in your vehicle, even for a short time.

They may pose a risk to themselves or to others by starting the engine, activating equipment such as the electric windows or locking the doors.

Also, in hot and/or sunny weather, please remember that the temperature inside the passenger compartment increases very quickly.

RISK OF DEATH OR SERIOUS INJURY.

Unlocking the charging cable

Press button **5** to unlock the vehicle charging cable.

CARD

Card: deadlocking

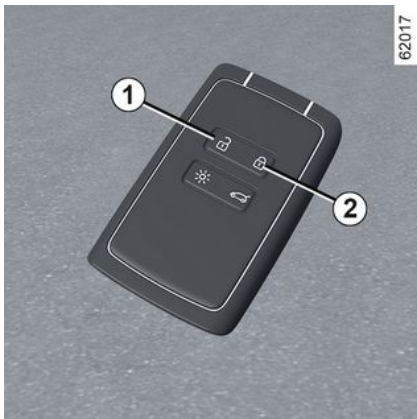

If the vehicle is equipped with a deadlocking function, this allows you to lock the opening elements and to prevent the doors from being unlocked using the interior handles (for example, by breaking the window and then trying to open the door from the inside).



Never use deadlocking if someone is still inside the vehicle.

To activate deadlocking

Press button **2** twice in quick succession.

Locking is confirmed by **two slow flashes and three quick flashes** of the hazard warning lights and side indicator lights.

Depending on the vehicle, the door mirrors may fold in automatically when the vehicle is locked → 146.

To deactivate deadlocking

Press button **1** once.

The hazard warning lights **flash once** to indicate that the doors have been unlocked.

"Hands-free" card: battery

Replacing the battery

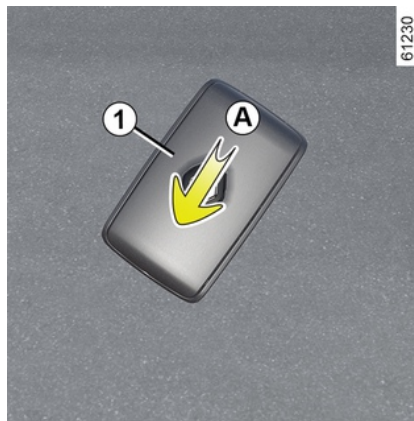

When the "Keycard Battery Low" message appears on the instrument panel, replace the card battery:

- slide the rear casing **1** downwards while pressing on area **A**;
- remove the battery cover **2**;
- remove the battery by pressing on one side and lifting the other;
- replace it according to the direction and template indicated inside the cover.





To refit, proceed in the reverse order then press one of the buttons on the card four times while you are near the vehicle: the next time the vehicle is started, the message will disappear. Check that the cover is clipped shut.

CARD

Note: when replacing the battery, do not touch the electronic circuit or contacts on the card.

 The batteries are available from approved Dealers, and their service life approximately two years. Check that there is no dye on the battery: risk of an incorrect electrical contact.

 If they need to be replaced, be sure to use the same or equivalent type of battery (consult an Approved Dealer).

 When replacing:
– make sure that the batteries are correctly inserted.

Risk of explosion.

– if the flap does not close correctly, do not use the card and keep out of reach of children.

Operating faults

If the battery is too weak to ensure correct operation, you will still be able to start and lock/unlock the vehicle → 64.

611496



 Do not throw away your used batteries as rubbish. Take them to an approved Dealer or consult your local authority for information on appropriate recycling facilities.



Precautions relating to batteries:

- keep batteries (new or used) out of reach of children;
- do not swallow batteries;

Risk of chemical burns which may lead to death.

- if ingested or inserted into any part of the body, consult a doctor as soon as possible.

DIGITAL KEY

General information

2

Depending on the country and subscription, you can install a digital key for your vehicle on your smartphone.

The digital key contains the rights required to lock/unlock and start your vehicle using a smartphone. Thus, your smartphone replaces your card.

The installation, administration and transmission of the digital keys are carried out using the manufacturer's app.

Once the manufacturer's application is installed on your smartphone and the subscription is activated, the digital key must be activated from the manufacturer's application.



If you need to entrust your vehicle to somebody else, make sure you have the vehicle card with you to guarantee access to the vehicle (e.g. in the context of an intervention on the vehicle, an appointment with an approved dealer or a qualified professional, etc.).



Secure access to the digital key on the smartphone

It is the responsibility of the owner of the digital key and the designated users to protect and secure access to the digital key on the smartphone.

Make sure that you install the necessary security and protection tools on your smartphone (such as securing the screen with a password).

Operating conditions

Activate Bluetooth® on your smartphone then open the manufacturer's application to access the various digital key functions.

Note: the smartphone must be sufficiently charged in order to use a digital key. In the event of a low charge level, the "Low smartphone battery" message appears on the instrument panel.



The digital key's operational reach will depend on your smartphone's Bluetooth® connection.

Lending a digital key

From the manufacturer's app, access the "Share Virtual Key " menu and fill in the information for the occasional user. After validation, a confirmation email will be sent to the user.



In the event of a loan, the owner of the digital key is responsible for designating a trusted person as a vehicle user.

To avoid any error in the transmission of a digital key to an occasional user (for example: lack of Wi-Fi or mobile network, etc.), be sure to anticipate the loan procedure.

To do this, make sure that:

- the manufacturer's application has previously been downloaded and installed by the occasional user.
- your smartphone and the occasional user's smartphone are connected to

DIGITAL KEY

the internet throughout the procedure (via Wi-Fi or mobile networks);
– the occasional user's digital key is activated once the procedure is completed.

Revoking a digital key

The user can individually revoke a digital key. Once a digital key has been revoked, the user can activate a new key.

For more information, please see the manufacturer's application.

Activation/deactivation from the multimedia screen

It is possible to deactivate and reactivate the "Digital key" function so that the vehicle does not communicate with any digital key. Please refer to the multimedia instructions.

Note: deactivating the function will not delete existing digital keys. It only deactivates the vehicle's capacity to communicate with them.

Locking/unlocking the doors and luggage compartment, deadlocking, remote lighting

The first time the vehicle is unlocked or started using a new digital key or a new smartphone, it will take several

seconds for the vehicle to identify the digital key installed on your smartphone.

From your smartphone, with Bluetooth® activated, open the manufacturer's application and discover the various functions available for your digital key. They are identical to those of your card.

Special features related to unlocking the opening elements

Under certain circumstances (e.g. after eight days of the vehicle not being used), it is not possible to unlock the vehicle using a digital key: press the luggage compartment opening button then unlock your vehicle using your digital key.

These functions are:

- locking/unlocking all the opening elements: please see "Hands-free card: use" → 52;
- locking/unlocking the luggage compartment (depending on the vehicle): please see "Hands-free card: use" → 52;
- deadlocking (depending on the vehicle): please see "Hands-free card: deadlocking" → 58;
- remote lighting: please see the information on the "Remote lighting" function → 52;
- remote sounding of the horn (allows you to identify the vehicle from afar or

when parked in a crowded car park, for example);
– starting/stopping the engine: please see "Starting, stopping the engine" → 167.

Starting, stopping the engine



Upon first use and each time a new smartphone is used, it is necessary to calibrate your digital key with your vehicle.

To do this, activate Bluetooth® on your smartphone then follow the procedure from the manufacturer's application.

When calibrating, the smartphone must be placed in the placement area 1.

DIGITAL KEY

To start/stop the engine, the system checks that the smartphone is present in the placement area **1** before allowing the engine to be started.

For more information, please refer to the information on "Starting, stopping the engine" ➔ **167**.

The smartphone must remain in the vehicle throughout the journey.

Note:

If a digital key is being lent, you can delete it by carrying out the revoking procedure using the smartphone while it is placed in the placement area **1**.

Otherwise, the deletion request is left pending and is only confirmed once the engine is started using another digital key or a card.



It is necessary to place the smartphone in the placement area in order to start and stop the engine and when calibrating.



If the smartphone is no longer in the passenger compartment when you try to switch the engine off, a message is displayed on the instrument panel: press and hold the engine start/stop button **2** for more than two seconds.

If the smartphone is no longer in the passenger compartment, make sure you can retrieve it before pressing and holding. Without a smartphone or card, you will not be able to start the vehicle again.

Special features of the digital key

– For the digital key to remain active, the smartphone concerned must be connected to the Internet (via WIFI or

mobile network) at least once every 48 hours. Otherwise, connect your smartphone to the internet for a few minutes so that the digital key can be reactivated.

– If a card has been left inside the vehicle and the doors have been locked with the digital key, all of the card's functions will be inhibited. The card's functions will remain inactive until the engine is started again.

In this case, to start the engine you will need to use either the digital key or a card other than that left inside the vehicle.



When the engine is started or stopped, the smartphone should always be sufficiently charged in order to use the digital key.

DOORS AND OPENING ELEMENTS

Opening and closing the doors

Opening from the outside

Front doors and rear doors

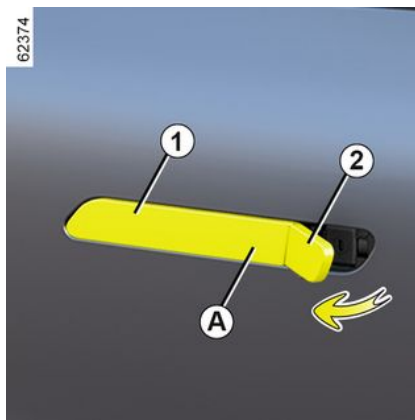
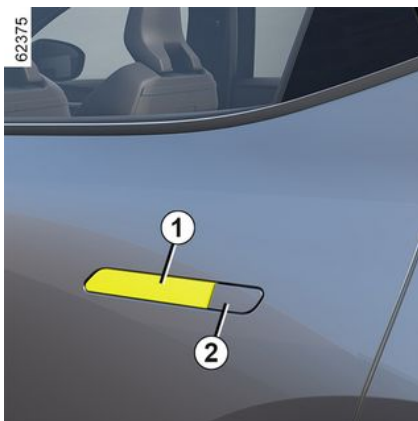

The front doors and rear doors are equipped with handles that fold out and in automatically according to the vehicle status:

- when the vehicle is unlocked, the handles fold out to allow access to the vehicle;
- when the vehicle is locked, the handles fold in;
- above 3 mph (5 km/h), the handles fold in;
- when reversing, the handles fold in.

Once deployed, the handles fold in automatically after about three minutes if no action is performed on the opening elements.

The handle can be brought out manually as well as electrically. To do this,

move the lock cover **2** and grip the end **A** of the handle **1** using your finger.



As a safety precaution, the doors should only be opened/closed when the vehicle is stationary.

2

Opening from the inside



Pull the handle **4**.

From inside the vehicle, the front exterior handles can be folded out:

- by opening a door;

DOORS AND OPENING ELEMENTS

– by pressing the central locking button once when the vehicle is locked or twice when it is unlocked.

When driving, the handles fold in automatically:

- as soon as the vehicle speed exceeds approximately 3 mph (5 km/h);
- when reversing.

Lights-on reminder buzzer

A warning beep sounds when the driver's door is opened to warn you that the lights are still on.

Door or luggage compartment lid open buzzer

When the vehicle is stationary, the

 warning light appears on the instrument panel accompanied by a warning light indicating which of the opening elements (door(s), luggage compartment) are open or incorrectly closed.

Once the vehicle reaches a speed of approximately 12 mph (20 km/h), a warning light indicates if the door(s) or luggage compartment are open or not properly closed and the "Luggage compartment open" or "Door open" message and a beep will sound for around 40 seconds until the door or luggage compartment is closed.

Special feature

Once the engine has been switched off, the lights and accessories (radio, etc.) will continue to operate until the driver's door is opened.

Child safety



To make it impossible for the rear doors to be opened from the inside, lower the lever **8** and check from the inside that the doors are securely locked.



Driver's responsibility when parking or stopping the vehicle

Never leave an animal, child or adult who is not self-sufficient alone in your vehicle, even for a short time.

They may pose a risk to themselves or to others by starting the engine, activating equipment such as the electric windows or by locking the doors.

Also, in hot and/or sunny weather, please remember that the temperature inside the passenger compartment increases very quickly.

RISK OF DEATH OR SERIOUS INJURY.

Locking, unlocking the opening elements and doors

If the card does not work:

In certain cases, the card may not work:

- when the card battery is worn, the battery is flat, etc;
- due to the use of electronic devices near to the remote control (e.g. mobile telephone);

DOORS AND OPENING ELEMENTS

- the vehicle is located in a high electromagnetic radiation zone;
- vehicle locked using a digital key → 60.

It is then possible:

- to use the key that is built into the card;
- to lock each of the doors manually;
- to use the interior door locking/unlocking control;
- to use the digital key → 60, depending on the vehicle.

The card's built-in key

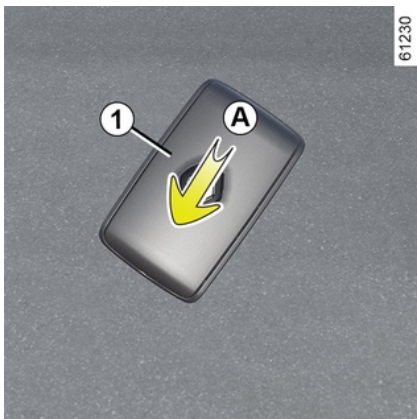

The built-in key **2** is used to lock or unlock the front left-hand door if the card is not working.

Access with key 2

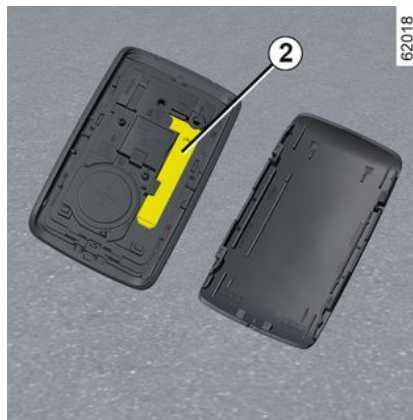

Slide the rear casing **1** downwards while pressing on area **A**.

Using the key integrated in the card

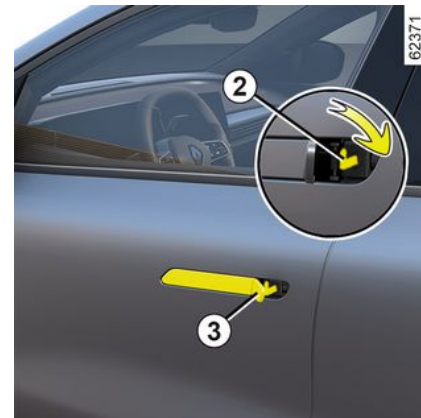

Move the lock cover **3** by pressing the left part and insert the key **2** into the lock in order to lock or unlock the driver's door.

2

DOORS AND OPENING ELEMENTS

Locking the doors manually



With the door open, turn the screw **4** (using the end of the key) and close the door.

This means that the door is then locked from the outside.

The doors may then only be opened from the inside or by using the key in the front left-hand door.

Interior locking/unlocking door control



The switch **5** simultaneously controls the doors and the luggage compartment door.

If a door or the tailgate is open or not closed properly, the doors and tailgate lock/unlock quickly.

If transporting an object with the luggage compartment door open, you can still lock the doors: **with the ignition off**, press and hold the switch **5** for more than five seconds to lock the other opening elements.

Door and tailgate status indicator

With the ignition on, the switch **5** warning light indicates the locking status of the opening elements:

- when the warning light is on, the doors and luggage compartment door are locked;
- indicator light off, the doors and tailgate are unlocked.

If the ignition is off, when you lock the doors the warning light remains lit for some time before disappearing.

 After locking/unlocking the vehicle using the buttons on the card, the remote locking and "hands-free" unlocking modes are deactivated. To reactivate the "hands-free" mode, restart the vehicle.

Locking the doors without the card

For example, in the event of a discharged battery or the card temporarily not working, etc.

With the ignition switched off and a door or the luggage compartment door open, press and hold the switch **5** for more than five seconds.

DOORS AND OPENING ELEMENTS

When the door is closed, all the doors and tailgate will be locked.

Note: unlocking the vehicle from the outside is only possible while the card is in the vehicle's access zone or using the key that is built into the card.



Never leave your vehicle with the card inside.



Driver's responsibility

If you decide to keep the doors locked when you are driving, remember that it may be more difficult for those assisting you to gain access to the passenger compartment in the event of an emergency.

Automatic locking when driving

Operating principle



After the vehicle is started, the system automatically locks the doors when you reach approximately 6 mph (10 km/h).

The door can be unlocked:

- by pressing the door unlocking switch **1**;
- at a standstill, by opening a front door from inside the vehicle.

Note: if a door is opened/closed, it will automatically lock again when the vehicle reaches a speed of approximately 6 mph (10 km/h).

Activating/deactivating the function

To activate it: with the vehicle stationary and the engine running, press switch **1** for at least five seconds until you hear a beep.

To deactivate it: with the vehicle stationary and the engine running, press switch **1** for at least five seconds until you hear two beeps.

The function can also be activated and deactivated via the multimedia screen → **136** (depending on the vehicle).

Operating faults

If you experience an operating fault (no central locking, the switch light **1** does not light up when trying to lock the doors and luggage compartment, etc.), make sure that central locking has not been deactivated by mistake and check that all of the opening elements are properly closed. If they are properly closed, contact an approved dealer.

DOORS AND OPENING ELEMENTS

2



Driver's responsibility

If you decide to keep the doors locked when you are driving, remember that it may be more difficult for those assisting you to gain access to the passenger compartment in the event of an emergency.

Luggage compartment

Opening



Press button **1** and lift the luggage compartment door.

Closing

Lower the luggage compartment lid, depending on the vehicle, initially using the inside handle to assist you.



Never use the struts to close the luggage compartment door.

Opening manually from inside the vehicle



If it is impossible to unlock the luggage compartment, it can be done manually from inside:

- access the luggage compartment by folding down the rear bench seatback(s);
- insert a flat-blade screwdriver or similar tool at the emergency opening lever **2** and slide it to the left as shown on the drawing;
- push the boot lid to open it.



The attaching of any carrying device (bike rack, luggage box, etc.) resting on the luggage compartment lid is prohibited. To install a carrying device on your vehicle, contact an Approved Dealer.

DOORS AND OPENING ELEMENTS

Charging lead storage tray



This tray is for charging leads. The maximum permissible load for the tray is 15 kg.

To access it, open the luggage compartment, then raise the luggage compartment carpet using the handle **3**.



If there is water in the charging lead storage tray, signs of corrosion or foreign bodies in the charging lead connector or in the vehicle charging socket, do not charge the vehicle.

Fire hazard.

Take care of the lead: do not tread on it, immerse it in water, pull on it or let anything knock against it.

Check and clean the storage tray regularly.

Rear parcel shelf



To remove it:

DOORS AND OPENING ELEMENTS

- lower the rear headrests;
- unhook the two suspension cords **4**;
- lift the shelf **5** to unclip it;

 Maximum weight on the rear parcel shelf: 2 kg evenly distributed.

- push the shelf **5** inwards and turn it;
- pull the shelf towards you.

To refit, proceed in the reverse order to removal.



Do not place any objects, especially heavy or hard objects, on the parcel shelf.

These may pose a risk to the vehicle occupants if the driver has to brake suddenly or if the vehicle is involved in an accident.

Automatic tailgate

Conditions of use

- Immobilise the vehicle.
- If there is any ice or snow preventing the tailgate from opening, this ice or

snow must be removed to free the tailgate.

- In the event that the battery is discharged or if it is replaced, the tailgate should be closed (manually if necessary) to restart the tailgate motor.

Opening/Closing

The opening or closing of the motorised tailgate is indicated by **three sound signals**.



Ensure that nobody is close to the moving parts when opening/closing the tailgate.

Risk of injury.

Depending on the equipment, the tailgate locks and unlocks at the same time as the doors.

The following modes are available to manoeuvre the tailgate:

- using the card as a remote control
- using the controls on the bumper
- using the dashboard control



To avoid damaging the tailgate system, do not manually force the tailgate to open or close while it is moving.



As a safety precaution, the doors should only be opened/closed when the vehicle is stationary.

Risk of injury.

using the remote control card



DOORS AND OPENING ELEMENTS

With the engine off, press and hold the switch **1** on the card while near the luggage compartment.

Using the tailgate exterior opening control



Press the control **2**.

Using the tailgate interior closing control



Press the control **3**.

Using the dashboard control



To open the tailgate, press and hold the switch **4** until you hear the beep, then immediately release the switch.

Note: if the switch is not released quickly enough (within approximately one second) after the beep, the tailgate will not open. In this case, repeat the sequence.

To close the tailgate, press and hold the switch **4** until the tailgate closes completely. A beep sounds throughout the operation.

Note: if you let go of the switch **4** before the tailgate is completely closed, the closing operation is interrupted.

DOORS AND OPENING ELEMENTS

Stopping the tailgate manoeuvre

The automatic tailgate manoeuvre can be stopped at any time by a short press on one of the controls.

If the tailgate is stationary in the intermediate position, your next press will move the tailgate in the opposite direction to when you stopped it.

Manual mode

After stopping the tailgate, you can perform the manoeuvre manually if you wish.

You can switch to the automatic manoeuvre at any time by pressing one of the controls.

Obstacle detection



If the tailgate detects an obstacle during its manoeuvre then it will stop. It will then be released from the obstacle following a small movement in the opposite direction, before stopping completely.

Press a tailgate opening/closing control to resume the tailgate operation.



The obstacle detection is an aid to opening and closing the tailgate, it does not in any way replace the user's care or responsibility.

Ensure that nobody is close to the moving parts when opening/closing the tailgate.

When opening/closing the tailgate, small objects may not be detected.

Ensure that no body parts (arms, hands, fingers etc.) are near the moving tailgate parts.

The detection is inactive at the end of the movement, before the tailgate is fully closed.

If the tailgate jams, stop the operation by pressing briefly on one of the controls.

Risk of serious injury.

DOORS AND OPENING ELEMENTS

Limiting the tailgate opening angle



You can adjust the maximum tailgate opening height. It will always stop at the chosen position:

- open the tailgate to an intermediate position;
- manually adjust the tailgate to the chosen position;
- press the motorised tailgate control **3** for more than three seconds to save the position.

Two beeps will sound to notify you that the position has been saved.

User precautions

- Before opening/closing the tailgate, ensure that the surrounding space is

sufficient to allow the tailgate to operate. If not, stop the tailgate movement.

- Avoid multiple manual stops during the automatic tailgate movement (risk of damaging the tailgate system).

Operating faults

If you activate the automatic tailgate continuously for around a minute (sequence of opening and closing), it will stop in order to avoid overheating. The operation will return to normal after about a minute.

The automatic tailgate will not operate if the battery is on low charge. In this case, operate the automatic tailgate with the engine running.

Note: in very cold weather conditions, the automatic opening may not work if the tailgate seals are frozen.



Driver's responsibility when parking or stopping the vehicle

Never leave your vehicle with a child, an adult who is not self-sufficient or a pet inside or at the rear of the tailgate, even for a short while.

They may pose a risk to themselves or to others by starting the engine, activating equipment such as the electric windows, the automatic tailgate or by locking the doors.

RISK OF DEATH OR SERIOUS INJURY.



The attaching of any carrying device (bike rack, luggage box, etc.) resting on the luggage compartment lid is prohibited. To install a carrying device on your vehicle, contact an Approved Dealer.

FACIAL RECOGNITION

2



After saving your profile from the multimedia system, it is possible to recall the driver's user settings (driving position, etc.) using the camera **A** when entering the vehicle.

For more information on storing a profile using facial recognition, please refer to the multimedia user manual.

The system is activated when the driver's door is closed. As soon as it detects a registered profile related to the facial recognition, the multimedia system suggests that you use this profile directly. If previously configured when creating the profile, an unlocking code is displayed on the multimedia system screen. In this case, enter your code.

The pre-stored settings will then be activated (driving position, phone connection, calendar, etc.).

If the face image is not recognised by the camera during recognition, the system suggests the last profile used.

Note: make sure that the camera is not obscured (by dirt, mud, etc.).



When recalling a position (memorisation, changing profile), make sure that no one is near the moving parts (in particular, in the rear seats).

For safety reasons, carry out any adjustments when the vehicle is stationary.

FRONT SEATS

Front headrests

To raise the headrest

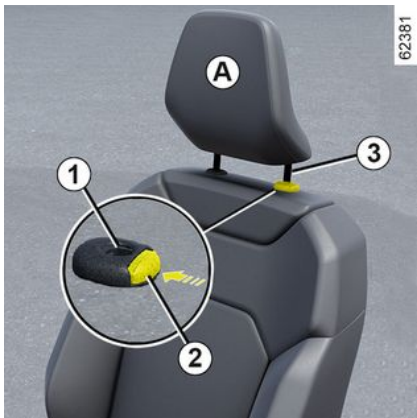

Pull the headrest upwards to the desired height. Check that it is correctly locked.

To lower the headrest

Press the button **2** and guide the headrest down to the desired height. Check that the bonnet is correctly locked.

To remove the headrest

Raise it to its highest position (tilt the seatback backwards). Press the button **2** and lift the headrest to release it.

To refit the headrest

Check that the headrest rods are clean **3**.

Insert the headrest rods into the holes **1** (tilt the seatback backwards). Lower the headrest until it locks and press button **2** to adjust to the desired height. Check that each rod **3** is locked on the seatback.

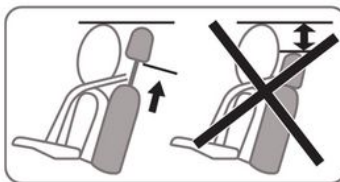

The headrest is an important safety component: ensure that it is in place and in the correct position. The top of your head should be in line with the top of the headrest. The distance between your head and section **A** should be as short as possible.

Front seats

Front seats with manual control

To move the seat forwards or back



FRONT SEATS

Raise the handle **1** to unlock. Release the handle at the desired position and make sure that it is locked.

Adjusting the lumbar support on the driver's seat

(depending on the vehicle)

Push the switch **2** forwards or backwards to adjust the lumbar pad.

To raise or lower the seat base

Move lever **3** as many times as necessary upwards or downwards.

To tilt the seatback

Raise the handle **4** as far as possible and tilt the seatback to the desired position. Release the handle at the desired position and make sure that it is locked.



After making adjustments, make sure that the seatbacks are correctly locked in place.



For safety reasons, carry out any adjustments while the vehicle is stationary.

We would advise you not to recline the seatbacks too far to ensure that the effectiveness of the seat belts is not reduced. Nothing should be placed on the floor (area in front of the driver) as these objects may slide under the pedals during sudden braking manoeuvres, thus obstructing their use.

Heated seats



Depending on the vehicle, with the ignition on, you can activate the heated seats via the multimedia screen **5**:

- pressing the  pictogram on the required seat for the first time activates the heating system at maximum power. Three switch-integrated warning lights are illuminated;
- a second press decreases the heating to medium power. Two integrated warning lights are illuminated;

FRONT SEATS



- a third press decreases the heating to minimum power. One integrated warning light is illuminated;
- a fourth press turns the heating off.

In order to avoid unnecessary energy consumption, the heated passenger seat can be deactivated automatically in the absence of an occupant.

"Favourites" function

Depending on the vehicle, by pressing the steering wheel control **6**, you can activate the heated seats according to the stored user settings that you have previously defined.

For more information on programming this function, please refer to the multimedia instructions.

Front seats with electric controls



Depending on the vehicle, the driver's front seat is equipped.

Use switch **1** to access the "Seats" menu on the multimedia screen.

Adjusting the seatback

To tilt the seatback, move the top of switch **2** forwards or backwards.

Adjusting the lumbar support on the driver's seat

Move the switch **3** forwards, backwards, upwards or downwards.

Adjusting the seat position



To move the seat forwards or back
Move the switch **4** forwards or backwards.

To raise or lower the seat base
Move the rear of the switch **4** upwards or downwards.

2

FRONT SEATS

2



For safety reasons, carry out any adjustments while the vehicle is stationary.

We would advise you not to recline the seatbacks too far to ensure that the effectiveness of the seat belts is not reduced.

Nothing should be placed on the floor (area in front of the driver) as these objects may slide under the pedals during sudden braking manoeuvres, thus obstructing their use.

Heated seats



Depending on the vehicle, with the ignition on, you can activate the heated seats via the multimedia screen **5**:

- pressing the  pictogram on the required seat for the first time activates the heating system at maximum power. Three switch-integrated warning lights are illuminated;
- a second press decreases the heating to medium power. Two integrated warning lights are illuminated;



- a third press decreases the heating to minimum power. One integrated warning light is illuminated;
- a fourth press turns the heating off.

In order to avoid unnecessary energy consumption, the heated passenger seat can be deactivated automatically in the absence of an occupant.

"Favourites" function

Depending on the vehicle, by pressing the steering wheel control **6**, you can activate the heated seats according to the stored user settings that you have previously defined.

For more information on programming this function, please refer to the multimedia instructions.

FRONT SEATS

Functions



A number of seat functions are available from the multifunction screen, depending on the vehicle.

On equipped vehicles, the switch **A** can be used to directly access the "Seats" menu on the multimedia screen.



"Lumbar activated" function

(depending on the vehicle)

You can activate the "Lumbar activated" function for the driver's seat or, depending on the vehicle, for the front passenger seat.

With the ignition on, from the multimedia screen select the "Vehicle" world **1**, "Seats", then "Lumbar activated".

Browse through the "Driver" or "Passenger" menu to:

- select the sequence type ("Low", "Extended", "Alternate");
- adjust the intensity;
- activate/deactivate the massage seat.

Press and hold the switch **A** of the seat for which you would like to activate the "Lumbar activated" function, according to the defined parameters.

Settings

Refer to the multimedia instructions for information on accessing the settings.

You can activate or deactivate the following elements:

- easy driver/passenger access;
- visual feedback of current movement.

Note: if the user profile is "Guest", the automatic adjustment functions will not be available.

Seat Easy access

When the function is activated:

- the driver's seat, with the vehicle stationary:
 - moves backwards when the door is opened (if the engine is off) or when the engine is switched off (if the door is open);
 - advances when the engine is started (if the door is closed) or when the door is closed (if the engine is running);
- the passenger seat moves backwards when the door is opened and advances when the door is closed.

2

FRONT SEATS

The seats move automatically. You can interrupt the movement by pressing one of the seat adjustment buttons **3**, **4** and **5**.

2



Deactivate the "Seat Easy access" function before installing a child seat on the front passenger seat and/or on the rear seats.
Risk of injury.

Position



61943

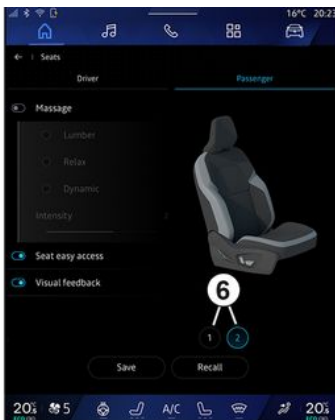

62479

Storing your driving position

- Adjust the driver's seat using buttons **3**, **4** and **5** → **77**;
- adjust the door mirrors → **146**.

Refer to the multimedia instructions for information on accessing the stored driving position.

The positions of the exterior rear view mirrors when driving forwards, in reverse and of the driver seat are saved.

Recalling the driving position

For more information on storing the driving position, please refer to the multimedia instructions.

You can interrupt the stored driving position reminder by pressing one of the seat adjustment buttons **3**, **4** and **5**.

« Relax position »

With the vehicle stationary, you can move back and tilt the driver's seat to enable a relaxing seating position while taking a break: press "Activate" **2**.

You can interrupt the movement in progress by pressing one of the seat adjustment buttons **3**, **4** and **5** or via the multimedia screen by pressing "Return to the driving position".

Note: while the vehicle is charging, a message is automatically displayed on

FRONT SEATS

the multimedia screen to ask if you would like to activate the position. During activation, you can access the "Relax position" settings;

For further information on the "Relax position", please refer to the multimedia instructions.



Before using "Relax position" or recalling a driving position (position memory, changing the profile), ensure that nobody is near any of the moving parts (especially on the rear seats).

Risk of injury.

REAR SEATS

Rear headrests

2

To raise the headrest



To remove the headrest

Tilt the bench seat forwards then press button **1** and remove the headrest.

To refit the headrest

Tilt the bench seat forwards, then insert the rods into the holes and push in the headrest until it locks. Check that the bonnet is correctly locked.

Rear bench seat: functions

Functions



To fold down the seatback

Ensure that the front seats are far enough forward.

Before folding down a seatback, fasten the seat belt. This prevents the seat belt from locking when the seatback is lifted up again.

Pull the strap **1** and lower the seatback **A**.

REAR SEATS



 Make sure the cup holders and armrest storage cover are closed before handling the seats → 327.

 When moving the rear bench seat, ensure that nothing obstructs the anchorage points (body parts, pets, gravel, cloths, toys, etc.).

To raise the seatback

Proceed in reverse order.

Raise the seatback again until it reaches the locking joint of the seatback. Be careful not to jam the seat belt between the seatback and the parcel shelf.

Check the operation of the seat belt.

 Do not use the central rear seat while the armrest is lowered.

SEAT BELTS

Always wear your seat belt when travelling in your vehicle. You must also comply with the legislation of the particular country you are in.

Before starting, first adjust your driving position, then ask all occupants to adjust their seat belts to ensure optimum protection.

Seat belts

Adjusting your driving position

- **Sit well back in your seat** (having removed your coat or jacket, etc.). This is essential to ensure that your back is positioned correctly;
- **adjust the distance between the seat and the pedals.** Your seat should be as far back as possible while still allowing you to fully depress the pedals. The seatback should be adjusted so that your arms are slightly bent when you hold the steering wheel;
- **adjust the position of your headrest.** For maximum safety, your head must be as close as possible to the headrest;
- **adjust the height of the seat.** This adjustment allows you to select the seat position which offers you the best possible view;
- **adjust the position of the steering wheel.**



Make sure that the rear bench seat → 82 is locked in position correctly so that the rear seat belts will operate correctly.



Incorrectly adjusted or twisted seat belts may cause injuries in the event of an accident.

Use one seat belt per person, whether child or adult.

Even pregnant women should wear a seat belt. In this case, ensure that the lap belt is not exerting too much pressure on the abdomen, but do not allow any slack.

Adjusting the seat belts



To ensure the correct adjustment and positioning of the seat belts on all seats:

- adjust the seats (seat position and seatback angle, if available);
- sit with your back firmly against the seatback;
- move the shoulder strap **1** as close as possible to the base of the neck without it actually resting against it (if necessary, adjust the height of the seat belt if possible) and make sure that the shoulder strap **1** is in contact with the shoulder;
- position the lap belt **2** so that it lies flat on the thighs and against the pelvis.

SEAT BELTS

The seat belt must be worn as close to the body as possible. e.g. avoid wearing heavy clothing, keeping bulky objects under the belts, etc.

Locking

Unwind the belt **slowly and smoothly** and ensure that the buckle **3** locks into the catch **5** (check that it is locked by pulling on the buckle **3**).

If the belt jams, allow it to return slightly before attempting to unwind it again.

If your seat belt is completely jammed, pull slowly, but firmly, so that just over 3 cm unwinds. Allow it to return slightly before attempting to unwind it again.

If there is still a problem, contact an approved dealer.

Unlocking

Press the button **4** and the seat belt will be rewound by the inertia reel. Guide the belt.

Seat belt reminder warning lights

Front and rear seat belt reminder warning

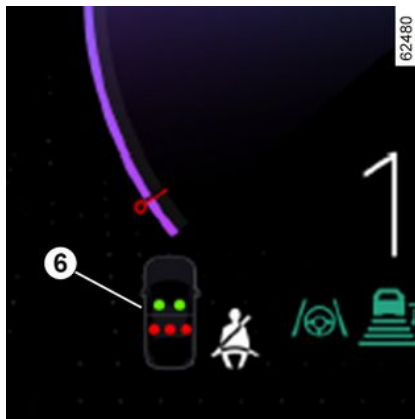

With the doors closed, the graphic **6** is displayed on the instrument panel for approximately 60 seconds when the vehicle ignition is switched on. This informs the driver of the fastening status of each of the seat belts every time:

- the doors are opened during driving (vehicle speed above zero);
- a seat belt is fastened/unfastened.

Understanding the graphic 6:

- symbol in green: seat belt fastened;

- symbol in red: the seat is occupied and the seat belt is not fastened;
- symbol in grey: seat not occupied.

With the doors closed, the  warning light appears on the central display when the vehicle ignition is switched on if the driver's and/or passenger's seat belt(s) (if this seat is occupied) are not fastened.

When the vehicle speed is less than approximately 12 mph (20 km/h), the

 warning light appears on the central display if a seat is occupied and the seat belt is not fastened.

It is accompanied by the graphic **6** which appears for approximately 60 seconds each time one of the seat belts is fastened or unfastened.

When the vehicle speed reaches exceeds approximately 12 mph (20 km/h), if one of the seat belts is or becomes unfastened during the journey:

- the  warning light flashes on the central display;
- and
- a beep sound for approximately 120 seconds;
- and

SEAT BELTS

– the graphic **6** is displayed for approximately 180 seconds and the symbol for the seat concerned changes to red.

Always make sure that the front passengers are properly fastened in and that the number of seat belts indicated as fastened corresponds to the number of seats occupied.

Note: in some cases, the warnings may be triggered if an object is placed on one of the seats.

Adjusting the height of the front seat belts



Press the button **7** to adjust the seat belt height, so that the shoulder strap is worn as shown previously. Press the

button **7** and raise or lower the seat belt. Make sure that the seat belt is locked in position correctly after you have adjusted it.

Rear seat belts

Rear side seat belts 8



The belts are fastened, unfastened and adjusted in the same way as the front belts.

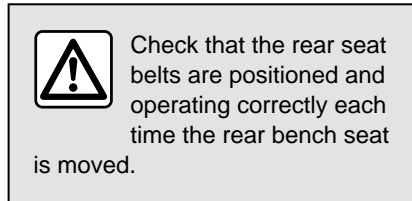

Rear centre seat belt 9

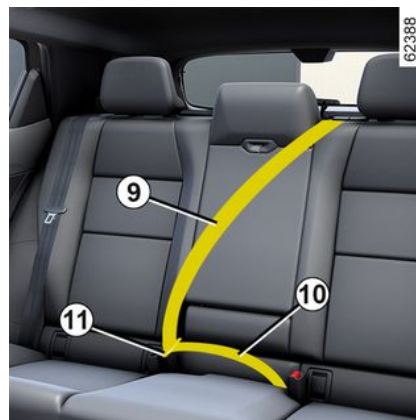

Slowly unwind the belt **9**.

Fasten the buckle **10** into the red catch unit **11**.

SEAT BELTS

Warnings

The following information applies to the vehicle's front and rear seat belts.



- No modification must be made to the originally-fitted restraint system components (seat belts, seats and their mountings). For special operations (e.g. fitting child seats) please contact an approved dealer.
- Do not use devices which give any slack in the belts (e.g. clothes pegs, clips, etc.), as a seat belt which is worn too loosely risks causing injury in the event of an accident.
- Never wear the shoulder strap under your arm or behind your back.
- Never use the same belt for more than one person and never hold a baby or child on your lap with your seat belt around them.
- The belt should never be twisted.
- Following an accident, have the seat belts checked and replaced if necessary. Always replace your seat belts as soon as they show any signs of wear.
- When the rear bench seat is being put back, make sure that the seat belts and buckles are correctly positioned so that they can be used properly.
- Make sure that the seat belt buckle is inserted into the appropriate catch.
- Ensure that no objects are placed in the area around the seat belt catch as they could prevent it from being properly secured.
- Make sure the seat belt catch is properly positioned (it should not be hidden away, crushed or flattened by people or objects).

ADDITIONAL SAFETY DEVICES

2

Methods of restraint in addition to the front seat belts

They consist of:

- seat belt inertia reel pretensioners;
- lap seat belt pretensioners;
- chest force limiters;
- airbags driver and passenger front.

These systems are designed to act independently or together when the vehicle is subjected to a frontal impact.

Depending on the severity of the impact, the system can cause:

- blocking of the seat belt;
- the seat belt inertia reel pretensioner which is triggered to correct seat belt slack;
- the lap seat belt pretensioner to hold the occupant in their seat;
- the front airbag.

Pretensioners

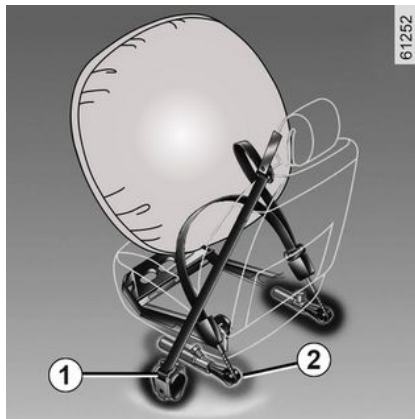

The pretensioners hold the seat belt against the body, holding the occupant more securely against the seat, thus increasing the seat belt's efficiency.

In the event of a severe frontal impact and if the ignition is switched on, the system may engage the following depending on the force of the impact:

- the seat belt inertia reel pretensioner **1** which instantly retracts the seat belt;
- the lap seat belt inertia reel pretensioner **2** on the front seats.



– Have the entire restraint system checked following an accident.

– No operation whatsoever is permitted on any part of the system (pretensioners, airbags, computers, wiring) and the system components must not be reused on any other vehicle, even if identical.

– Only qualified personnel from our Network may work on the pretensioners and airbags, otherwise the system may trigger accidentally and cause injury.

– The electrical trigger system may only be tested by a specially trained technician using special equipment.

– If scrapping your vehicle, contact an approved dealer for disposal of the gas generator of the pretensioners and airbags.

Load limiter

Above a certain severity of impact, this mechanism is used to limit the force of the belt against the body so that it is at an acceptable level.

ADDITIONAL SAFETY DEVICES



Driver and passenger front airbags

Fitted to the driver and passenger sides.

A symbol on the lower section of the windscreen indicates if this equipment is present (depending on the vehicle).

Each airbag system consists of:

- an airbag and gas generator fitted on the steering wheel for the driver and in the dashboard for the front passenger;
- an electronic unit for monitoring the system controlling the gas generator electrical trigger;
- remote sensors;
- control warning lights, displayed on the roof console **3**:

-  lit up, airbag passenger activated;
-  lit up, airbag passenger deactivated.



The airbag system uses pyrotechnic principles. This explains why, when the airbag inflates, it will generate heat, produce smoke (this does not mean that a fire is about to start) and sound like a detonation. In a situation where an airbag deployment is required, it will inflate immediately and this may cause some minor, superficial grazing to the skin or other problems.



Operation

This system is only operational when the ignition is switched on.

In a severe frontal impact, the airbags inflate rapidly, cushioning the impact of the driver's head and chest against the steering wheel and of the front passenger against the dashboard. The airbags then deflate immediately so that the passengers are not in any way prevented from leaving the vehicle.

Operating faults



This warning light comes on when the engine is started and then goes out after approximately 65 seconds.

ADDITIONAL SAFETY DEVICES

If it does not come on when the ignition is switched on or if it stays on, there is a fault in the system.

Contact your approved Dealer as soon as possible;

Your protection will be reduced until this fault is rectified.

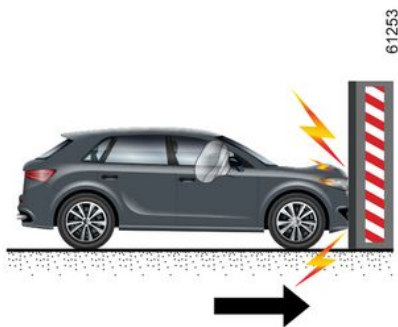

The following cases trigger the pretensioners or Airbags.

In a frontal impact against a rigid (non-deformable) surface at an impact speed equal to or greater than 16 mph (25 km/h).

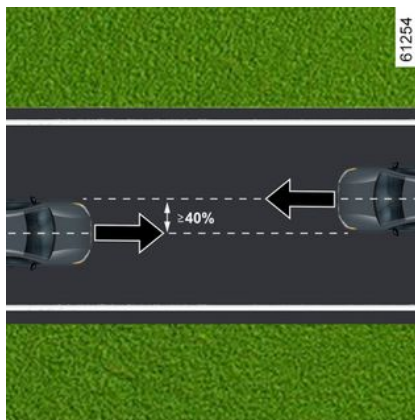

In the event of a frontal impact with another vehicle of an equivalent or higher category, with an impact area equal to or greater than 40%, where the speed of both vehicles is equal to or greater than 25 mph (40 km/h).

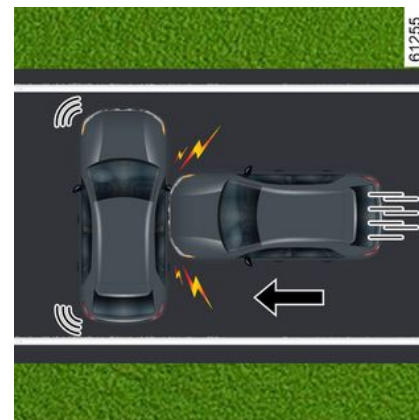

In a side impact with another vehicle of an equivalent or higher category, at an impact speed equal to or greater than 31 mph (50 km/h).

ADDITIONAL SAFETY DEVICES

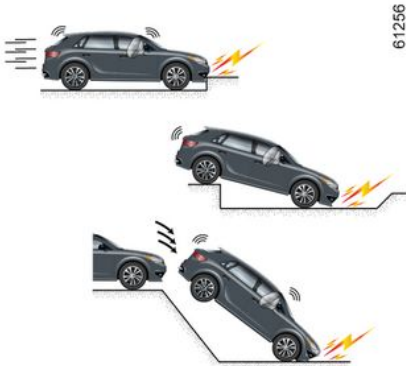

The pretensioners or Airbags may be triggered by:

- an impact underneath the vehicle (e.g. pavement kerb);
- potholes;
- a drop or hard landing;
- stones;
- ...



The pretensioners or Airbags may not be triggered by:

- a rear impact, however severe;
- the vehicle overturning;



- side impact at the front or rear of the vehicle;
- frontal impact, underneath the tail of a lorry;
- frontal impact against an obstacle with a sharp angle;
- ...

All of the warnings below are given so that the airbags not obstructed in any way when it is inflated and also to prevent the risk of serious injuries caused by items which may be dislodged when it inflates.

ADDITIONAL SAFETY DEVICES

Warnings

2



Warnings in relation to the driver's airbag

- Do not modify the steering wheel or the boss.
- Do not cover the steering wheel boss under any circumstances.
- Do not attach any objects (badge, logo, watch, telephone cradle, etc.) to the steering wheel boss.
- The steering wheel must not be removed (except by qualified personnel from our Network).
- Do not sit too close to the steering wheel: sit with your arms slightly bent (see "Adjusting your driving position" → 84). This will allow sufficient space for the airbag to deploy correctly and be fully effective.

Warnings in relation to the passenger airbag

- **Fitting seat covers on the front seats is prohibited as they may affect the operation of the passenger airbag .**
- Do not attach or glue any objects (badge, logo, clock, telephone holder, etc.) to the dashboard on or near the airbag.
- Do not place anything between the dashboard and the passenger (animal, umbrella, walking stick, parcels, etc.).
- The passenger must not put his or her feet on the dashboard or seat as there is a risk that serious injuries may be sustained. As a general rule, parts of the body should be kept away from the dashboard (knees, hands, head, etc.).

ADDITIONAL SAFETY DEVICES

Methods of restraint in addition to the rear seat belts

They consist of:

- **side seat belt inertia reel pretensioners;**
- **chest force limiters.**

These systems are designed to act independently or together when the vehicle is subjected to a frontal impact.

Depending on the severity of the impact, the system can cause:

- blocking of the seat belt;
- the seat belt inertia reel pretensioner (which engages to correct seat belt slack).

Load limiter

Above a certain severity of impact, this mechanism is used to limit the force of the belt against the body so that it is at an acceptable level.

Side seat belt pretensioners

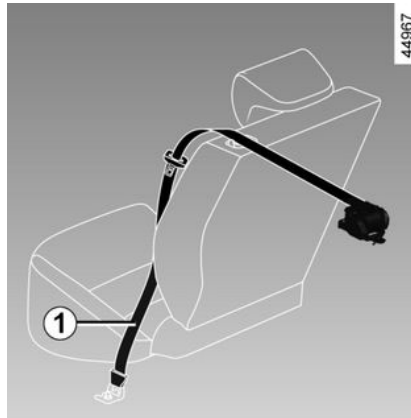

The pretensioners hold the seat belt against the body, holding the occupant more securely against the seat, thus increasing the seat belt's efficiency.

With the ignition on, following a significant frontal impact and depending on the severity of the impact, the system may trigger the seat belt inertia reel pretensioner **1** which instantly retracts the seat belt.



- Have the entire restraint system checked following an accident.
- Any operation on the entire system (pretensioners, airbags, electronic units, wiring) or re-use on any other vehicle, even identical, is strictly prohibited.
- To avoid the system triggering accidentally and causing injury, only qualified personnel from the brand network may work on the pretensioners and airbags.
- The electrical trigger system may only be tested by a specially trained technician using special equipment.
- If the vehicle is scrapped, contact an approved dealer to dispose of the gas generator of the pretensioners and airbags.

Side protection devices

Side airbag

This airbag is fitted to each of the front seats and is activated at the door side of the seats to protect the occupants in the event of a severe side impact.

ADDITIONAL SAFETY DEVICES

Curtain airbag

2 This airbag fitted in the ceiling along each side of the vehicle. They inflate along the front and rear door side windows to protect the passengers in the event of a severe side impact.

Central airbag

This airbag fitted to the driver's seat and deployed between the driver's seat and the passenger seat in order to protect the driver and passenger in the event of a severe side impact.

It also spreads out to protect the driver, if they are the only one in the front, in the event of a severe side impact.

ADDITIONAL SAFETY DEVICES

Warnings



Warning relating to the passengerairbag side airbag and theairbag central airbag

– **Fitting seat covers on the front seats is prohibited as this could hinder the operation of the passenger airbag status.**

- Do not place any accessories, objects or even pets between the seatback, the door and the internal fittings. Do not cover the seatback with objects such as clothes or accessories. This could hinder the operation of theairbag or lead to injury during inflation.
- Do not drive with the central armrest in the open position as this could hinder the operation of theairbag and/or lead to injury during inflation.
- Do not place any object(s) on the central armrest compartment cover as this could hinder the operation of theairbag and/or lead to injury during inflation.
- Do not leave any object(s) protruding from the central armrest compartment as this could hinder the operation of theairbag and/or lead to injury during inflation.
- No work or modification whatsoever may be carried out on the seat or internal fittings, except by qualified personnel from our Network.
- The slits on the front seatbacks (door side and centre console side) correspond to the airbags deployment zone: never insert any objects into these slits.

ADDITIONAL SAFETY DEVICES

Additional methods of restraint

2

All of the following warnings are provided to avoid interference with the deployment of the airbag and to avoid direct serious injury due to objects being projected when it is inflated.



The front passenger airbag is designed to complement the action of the seat belt, and the airbag and seat belts are integral parts of the same protection system. It is therefore essential to wear seat belts at all times. If seat belts are not worn, the occupants are exposed to an increased risk of serious injury in the event of an accident. It may also increase the risk of minor superficial injuries occurring when the airbag is deployed, although such minor injuries are always possible with the airbag itself.

The pretensioners or airbags are not automatically triggered if the vehicle overturns or in the event of a rear impact, however severe. Shocks to the underbody of the vehicle, from pavements, potholes, stones etc. can all trigger these systems.

- Any operation or modification on the complete system airbag (airbags, pretensioners, electronic unit, wiring, etc.) is **strictly prohibited** (except by qualified personnel from the brand network).
- To ensure that the system remains in good working order and to avoid accidental triggering of the system, only qualified personnel from the brand network may work on an airbag.
- As a safety measure, have the system checked airbag after the vehicle has been subject to an accident, theft or attempted theft.
- When selling or lending the vehicle, inform the new purchaser of these conditions when handing over this vehicle user manual.
- When scrapping your vehicle, contact your approved dealer for disposal of the gas generator(s).

CHILD SAFETY

General information

Carrying children

Please ensure that you comply with the legislation of your country.

Children, and adults, must be correctly seated and strapped in for all journeys. The children being carried in your vehicle are your responsibility.

A child is not a miniature adult. Children are at risk of specific injuries as their muscles and bones have not yet finished growing. The seat belt alone would not provide suitable protection. Use an approved child seat and ensure you use it correctly.



To prevent the doors being opened, use the "Child lock" feature → 63.



A collision at 31 mph (50 km/h) is the same as falling a distance of 10 metres.

Transporting a child without a restraint is the equivalent of allowing him or her to play on a fourth-floor balcony without railings. Never travel with a child held in your arms.

In the event of an accident, you will not be able to keep hold of the child, even if you yourself are wearing a seat belt.

If your vehicle has been involved in a road accident, replace the child seat and have the seat belts and ISOFIX anchorage points checked.



Driver's responsibility when parking or stopping the vehicle

Never leave an animal, child or adult who is not self-sufficient alone in your vehicle, even for a short time.

They may pose a risk to themselves or to others by starting the engine, activating equipment such as the electric windows or by locking the doors.

Also, in hot and/or sunny weather, please remember that the temperature inside the passenger compartment increases very quickly.

RISK OF DEATH OR SERIOUS INJURY.

Using a child seat

The level of protection offered by the child seat depends on its ability to restrain your child and on its installation. Incorrect installation compromises the protection it offers the child in the event of harsh braking or an impact.

Before purchasing a child seat, check that it complies with the regulations for the country you are in and that it can be fitted in your vehicle. Consult an ap-

CHILD SAFETY

proved Dealer to find out which seats are recommended for your vehicle.

The regulations on transporting children are specific to each country. The use of a child seat during transport depends on the age and/or the size and/or weight of the child.

For children who do not need to be transported in a child seat, make sure that the seat belt is correctly adjusted and fastened.

In all cases, you must comply with the regulations of the particular country you are in.

Before fitting a child seat, read the manual and respect its instructions. If you experience any difficulties during installation, contact the manufacturer of the equipment. Keep the instructions with the seat.



Set a good example by always fastening your seat belt and teaching your child:

- to strap themselves in correctly;
- to always get in and out of the car at the kerb, away from busy traffic.

Do not use a second-hand child seat or one without an instruction manual.

Check that there are no objects in the vicinity of the child seat which could impede its operation.



Never leave a child unattended in the vehicle.

Check that your child is always strapped in and

that the belt or safety harness used is correctly set and adjusted. Avoid wearing bulky clothing which could cause the belts to slacken → 84.

Never let your child put their head or arms out of the window.

Check that the child is in the correct position for the entire journey, especially if asleep.



Before installing a child seat on one of the rear seats, ensure that the "Easy Access Seat"

function is deactivated for the driver's and/or front passenger seat(s) → 79.

RISK OF INJURY.

CHILD SAFETY

Choosing a child seat

Rear-facing child seats



61260

A baby's head is, proportionally, heavier than that of an adult and its neck is very fragile. Transport the child in this position as long as possible (until the age of 2 at the very least). It supports both the head and the neck.

Choose a bucket type seat for best side protection and change it as soon as the child's head is higher than the shell.

Forward-facing child seats



61261

Up to 18 kg or 4 years, the child may travel on a forward-facing seat.

Choose your seat according to the child's size: their head and abdomen are the areas which must be most protected. A forward-facing child seat which is firmly attached to the vehicle will reduce the risk of impact to the head. Ensure your child travels in a forward-facing seat with a harness for as long as their size permits.

Choose a bucket type seat for optimum side protection.w

Booster cushions



61262

From 15 kg or 4 years, the child can travel using a booster seat, which will enable the seat belt to be adapted to suit his size and shape. The booster seat cushion must be fitted with guides to position the seat belt on the child's thighs rather than the stomach. It is recommended that you use a seatback which can be adjusted in terms of height to position the seat belt in the centre of the shoulder. It must never rest on the neck or on the arm.

Choose a bucket type seat for optimum side protection.w

CHILD SAFETY

Choosing a child seat mounting

There are two ways to attach child seats: using the seat belt or using the ISOFIX system.

Attachment via the seat belt

The seat belt must be adjusted in order to ensure it works in the event of sudden braking or impact.

Ensure that the strap paths indicated by the child seat manufacturer are observed.

Always check that the seat belt is correctly fastened by pulling it up, then pulling it out fully whilst pressing on the child seat.

Check that the seat is correctly held by moving it from side to side and back to front: the seat should remain firmly fixed.

Check that the child seat has not been installed at an angle and that it is not resting against a window.



Do not use the child seat if it risks unfastening the seat belt restraining it: the base of the seat must not rest on the buckle and/or catch of the seat belt.



The seat belt must never be twisted or the tension relieved.

Never pass the shoulder strap under the arm or behind the back.

Check that the seat belt has not been damaged by sharp edges. If the seat belt does not operate normally, it will not protect the child.

Consult an approved Dealer.

Do not use this seat until the seat belt has been repaired.

Attachment using the ISOFIX system

Authorised child seats ISOFIX are approved in accordance with current regulations if any of the four cases below applies:

- Universal ISOFIX 3-point forward-facing seat;
- Semi-universal ISOFIX 2-point seat;
- vehicle-specific;
- i-Size which has either:
 - a strap which attaches to the third ring of the seat concerned;
 - or a strut that rests on the vehicle floor, compatible with the approved

seat i-Size, the role of which is to prevent the child seat from moving in the event of a collision.

In the latter three cases check that your child seat can be installed by consulting the list of compatible vehicles.



No modifications must be made to the component parts of the originally fitted restraint system (seat belts, ISOFIX, seats and their mountings).

Attach the child seat with the ISOFIX locks, if these are provided. The ISOFIX system allows quick, easy and safe fitting.

The ISOFIX system consists of two rings and, in some cases, a third ring.

CHILD SAFETY



The ISOFIX anchorage points have been exclusively designed for child seats with the ISOFIX

system.

Never fit a different type of child seat, seat belt or other objects to these fittings.

Check that nothing is obstructing the anchorage points.

If your vehicle has been involved in a road accident, have the ISOFIX anchorage points checked and replace your child seat.



Before using an ISOFIX child seat that you purchased for another vehicle, check that its instal-

lation is authorised. Consult the list of vehicles which can be fitted with the seat with the equipment manufacturer.



The two rings **1** are located between the seatback and the seat base and

are identified by a  mark.

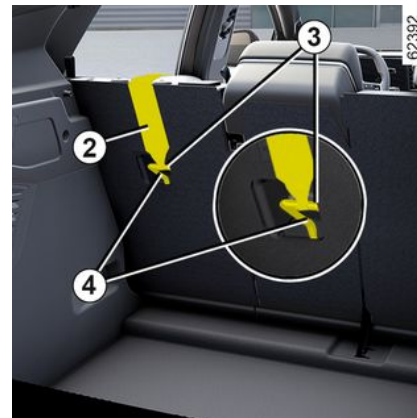

The third ring **4** is used to attach the upper strap on some child seats. **2** on some child seats.

Rear seats

The upper strap **2** should be positioned between the seatback and the rear parcel shelf. To do so, remove the rear parcel shelf → **68**.

Attach the hook **3** to one of the rings **4**

marked by the  symbol.

Front passenger seat

2

CHILD SAFETY

2

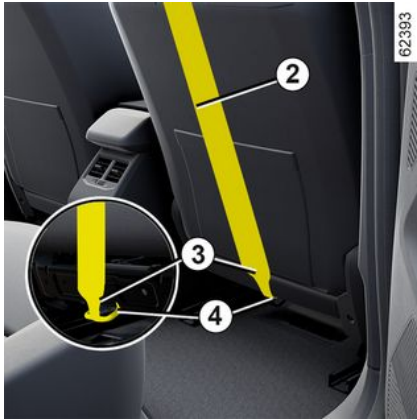

Attach the hook **3** of the upper strap **2**

to the ring **4** identified by the  symbol.

All seats

Pull the upper strap **2** so that the back of the child seat comes into contact with the back of the vehicle seat.



The ISOFIX anchorage points have been exclusively designed for child seats with the ISOFIX system. Never fit a different type of child seat, seat belt or other objects to these fittings. Check that nothing is obstructing the anchorage points. If your vehicle has been involved in a road accident, have the ISOFIX anchorage points checked and replace your child seat.



Check that the seatback of the forward-facing child seat is in contact with the seatback of the vehicle seat. In this case, the child seat may not always rest on the seat base of the vehicle seat.



The child seat strap **must** be attached to the corresponding ring.

CHILD SEATS

Fitting a child seat, general information

Some seats are not suitable for fitting child seats.

The diagrams on pages → 103 show you how to attach a child seat.



Fit the child seat in a rear seat wherever possible.

Make sure the child seat or the child's feet do not prevent the front seat from locking correctly → 75.

Check that when installing the child seat in the vehicle it is not at risk of coming loose from its base.

If you have to remove the headrest, check that it is correctly stored so that it does not come loose under harsh braking or impact.

Always attach the child seat to the vehicle even if it is not in use so that it does not come loose under harsh braking or impact.

The types of child seats indicated may not be available. Before using a differ-

ent child seat, check with the manufacturer that it can be fitted.

In the front seat

The laws concerning children travelling in the front passenger seat differ in every country. Consult the relevant legislation and follow the indications on the diagram.

Before fitting a child seat in this seat (if authorised):

- lower the seat belt as far as possible;
- move the seat as far back as possible;
- gently tilt the seatback away from the vertical position (approximately 25°);
- on equipped vehicles, raise the seat base as far as possible.

Always fully raise the seat headrest so that it does not interfere with the child seat → 75.

After installing the child seat, when this is possible, you can move the vehicle seat forward if necessary (so as to leave enough space in the rear seats for passengers or other child seats). For a rear-facing child seat, do not let it touch the dashboard or move it to the furthest forward position.

Do not change other settings after installing the child seat.



RISK OF DEATH OR SERIOUS INJURY: be-

fore fitting a rear facing child seat on the front passenger seat, check that the airbag has been deactivated → 117.

In the rear side seat

A carrycot can be installed across the vehicle and will take up at least two seats. Position the child with his or her feet nearest the door.

In order to install a rear-facing child seat, move the front seat as far forward as possible, then move the front seat back as far as it will go, without allowing it to come into contact with the child seat.

For the safety of the child in the forward-facing position:

- move the seat in which the child will be seated as far back as possible;
- Move the seat in front of the child forwards, and set the position of the seatback to avoid contact between the seat and the child's legs.

CHILD SEATS

2



Make sure the child seat or the child's feet do not prevent the front seat from locking correctly

→ 75.



Before installing a child seat on one of the rear seats, ensure that the "Easy Access Seat"

function is deactivated for the driver's and/or front passenger seat(s) → 79.

RISK OF INJURY.

In all situations, remove the headrest of the rear seat on which the child seat is positioned → 82. If necessary, position the rear seat as far back as possible. This must be done before fitting the child seat. Check that the child seat is resting against the back of the rear seat.



Installing a booster seat (group 2 or 3)

Check that the seat belt → 84 operates (winds)

correctly.

Adjust the seat belt by positioning:

- the shoulder strap on the child's shoulder without it touching their neck;
- the lap belt so that it lies flat on the thighs and against the pelvis.

If necessary, adjust the position of the vehicle seat.



Fit the child seat in a rear seat wherever possible.

To install a seat ISOFIX in the rear left-hand seat, unfasten the central seatbelt by hand before engaging the locks.



A child seat with a floor support must never be installed on the rear centre seat.

RISK OF DEATH OR SERIOUS INJURY.

In rear centre seat

Check that the belt is suitable for securing your child seat. Consult an approved Dealer.

CHILD SEATS

Attachment by seat belt

2

Fitting diagram

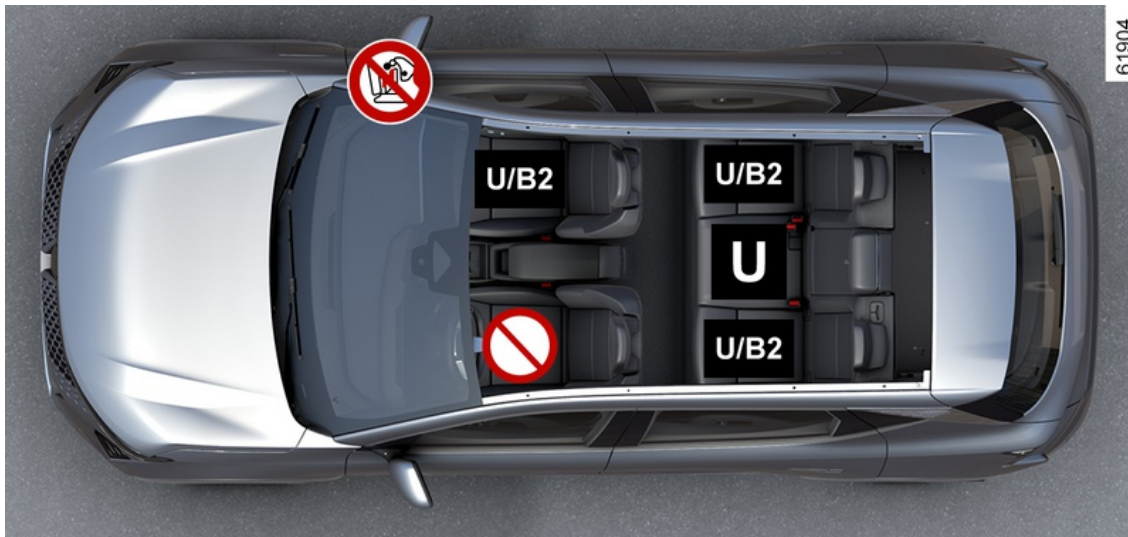

CHILD SEATS



RISK OF DEATH OR SERIOUS INJURY: before fitting a rear facing child seat on the front passenger seat, check that the airbag has been deactivated → 117.

2



Check the status of the airbag before fitting a child seat or allowing a passenger to use the seat.



Seat not suitable for fitting child seats.

Child seat attached using the belt



Seat equipped for attaching a "universal" approved seat using a seatbelt.



Seat enabling a child seat with "B2" approval to be attached by seat belt.



Using a child safety system which is not approved for this vehicle will not properly protect the baby or child. They risk serious or even fatal injury.



Check that your child is always strapped in and that the belt or safety harness used is correctly set and adjusted. If necessary, adjust the seat position accordingly.



Do not fit a child seat while the central seatback is folded down.

CHILD SEATS

Installation table

The table below summarises the information already shown on the diagram on the previous page, to ensure the regulations in force are respected.

Type of child seat	Weight of the child	Front passenger seat (7)		Rear side seats (7)	Rear centre seat (7)
		With airbag deactivated	With airbag activated		
Carrycot fitted across the vehicle Group 0	< 10 kg	X	X	U (2)	U (2)
Rear-facing shell seat Groups 0 or 0 +	< 10 kg and < 13 kg	U (1) (5)	X	U (3)	U (3) (6)
Shell seat/rear-facing seat Groups 0+ and 1	< to 13 kg and 9 to 18 kg	U (1) (5)	X	U (3)	U (3) (6)
Forward-facing seat Group 1	9 to 18 kg	X	U (5)	U (4)	U (4) (6)
Booster seat Groups 2 and 3	15 to 25 kg and 22 to 36 kg	X	U / B2 (5)	U / B2 (4)	U (4)



(1) RISK OF DEATH OR SERIOUS INJURY: before fitting a rear-facing child seat in the front passenger seat, check that the airbag has been deactivated → 117.

X = Seat not suitable for fitting child seats of this type.

U = Seat enabling a child seat with "Universal" approval to be attached by seat belt: check that it can be fitted.

B2 = Boosters in groups 2 and 3 (15 to 25 kg and 22 to 36 kg/33.1 to 55.1 lbs and 48.5 to 79.4 lbs).

CHILD SEATS

- (2) A carrycot can be installed across the vehicle and will take up at least two seats. Position the child with his or her feet nearest the door.
- (3) Before installing a rear-facing child seat, move the front seat forwards as far as possible then, once the child seat is installed, move the front seat backwards as far as possible without it touching the child seat.
- (4) In all situations, remove the rear headrest of the seat on which the child seat is positioned. This must be done before fitting the child seat. Move the seat in front of the child forwards, move the seatback forward to avoid contact between the seat and the child's legs.
- (5) Raise the seat to the maximum and position it as far back as possible, tilting the seatback slightly (approximately 25°).



(6) RISK OF DEATH OR SERIOUS INJURY: a child seat with a floor support must never be fitted.



(7) Deactivate the "Easy Access Seat" function before installing a child seat on the front passenger seat and/or on the rear seats → 79.
Risk of injury.

CHILD SEATS

Attachment using the ISOFIX system

2

Fitting diagram



CHILD SEATS



For the front passenger seat, the use of a child seat with a floor support is recommended to avoid triggering the seat belt warning signal.



Using a child safety system which is not approved for this vehicle will not properly protect the baby or child. They risk serious or even fatal injury.



Fitting a seat ISOFIX in the rear-left seat means the middle seat cannot be used. The central seat belt will no longer be either accessible or useable.



RISK OF DEATH OR SERIOUS INJURY: before fitting a rear facing child seat on the front passenger seat, check that the airbag has been deactivated → 117.



Seat which does not allow a child seat to be fitted.

Child seat attached using the ISOFIX system



Seat equipped for attaching a ISOFIX or i-Size child seat.



The front and rear seats are equipped with an anchorage point allowing an ISOFIX universal forward-facing child seat to be attached. The anchoring points are located on the passenger seatback for the front seat and on the bench seatback for the rear seats.

CHILD SEATS

2



Check that your child is always strapped in and that the belt or safety harness used is correctly set and adjusted. If necessary, adjust the seat position accordingly.



Do not fit a child seat while the central seatback is folded down.



Fit the child seat in a rear seat wherever possible.
To install an ISOFIX seat in this seat, unbuckle the seat belt by hand before engaging the bolts.

CHILD SEATS

Installation table

The table below summarises the information already shown on the diagram on the previous page, to ensure the regulations in force are respected.

Type of child seat	Weight of the child	Size of seat [fixture]	Front passenger seat (7)		Rear side seats (7)	Rear centre seat (7)
			With airbag deactivated	With airbag activated		
Carrycot fitted across the vehicle Group 0	< 10 kg	L1 [F] L2 [G]	X	X	IL (2)	X
Rear-facing shell seat Groups 0 or 0 +	< 13 kg	R1 [E]	IL (1) (3)	X	IL (4)	X
Rear-facing seat Groups 0+ and 1	< to 13 kg and 9 to 18 kg	R3 [C] R2 [D]	IL (1) (3)	X	IL (4)	X
Forward-facing seat Group 1	9 to 18 kg	F3 [A] F2 [B] F2X [B1]	X	IUF - IL (3)	IUF - IL (5)	X
Booster seat Groups 2 and 3	15 to 25 kg and 22 to 36 kg	B2	X	IUF - IL (3)	IUF - IL (5)	X
Seati-Size	Rear-facing seat		i - U (1) (3)	X	i - U (4)	X
	Forward-facing seat		X	i - UF (3)	i - U (5)	X
	Booster seat		X	i - UF (6)	i - U (5)	X

X = Seat not suitable for fitting child seats.

CHILD SEATS

IUF = Seat allowing a child seat with "Universal or vehicle-specific" approval to be attached using the ISOFIX system on equipped vehicles: check that it can be fitted.

IL = Seat allowing a child seat with "Semi-universal or vehicle-specific" approval to be attached using the ISOFIX system on equipped vehicles: check that it can be fitted.

i-U = Suitable for "Universal" front-facing and rear-facing i-Size restraint devices.

i-UF = Suitable only for "universal" front-facing and rear-facing i-Size restraint devices.



(1) RISK OF DEATH OR SERIOUS INJURY: before fitting a rear-facing child seat in the front passenger seat, check that the airbag has been deactivated → 117.

(2) A carrycot can be fitted across the vehicle and it will take up at least two seats. Position the child with his or her feet nearest the door.

(3) Move the vehicle seat backwards as far as possible and lower it as much as possible, then tilt the seatback slightly (by approximately 25°).

(4) Before installing a rear-facing child seat, move the front seat forwards as far as possible then, once the child seat is installed, move the front seat backwards as far as possible without it touching the child seat.

(5) In all situations, remove the headrest of the rear seat on which the child seat is positioned. This must be done before fitting the child seat. Move the seat in front of the child forwards, move the seatback forward to avoid contact between the seat and the child's legs.

(6) Raise the seat to the maximum and position it as far back as possible, tilting the seatback slightly (approximately 25°).

The size of the ISOFIX child seat is indicated by a letter:

- F3, F2, F2X [A, B, B1]: for forward-facing child seats in Group 1 (9 to 18 kg);
- B2: boosters in groups 2 and 3 (15 to 25 kg and 22 to 36 kg);
- R3, R2 [C, D]: rear-facing seats or shell seats in group 0+ (less than 13 kg) or group 1 (9 to 18 kg);
- R1 [E]: rear-facing shell seats in group 0 (less than 10 kg) or 0+ (less than 13 kg);
- L1, L2 [F, G]: carrycots in group 0 (less than 10 kg).

CHILD SEATS



(7) Deactivate the "Easy Access Seat" function before installing a child seat on the front passenger seat and/or on the rear seats → 79.

Risk of injury.

2

CHILD SAFETY: DEACTIVATING, ACTIVATING THE FRONT PASSENGER AIRBAG

Child safety: deactivating, activating the front passenger airbag

Front passenger airbag deactivation



Before installing a child seat on the front passenger seat:

- check that the child seat can be installed on this seat;
- it is essential to **deactivate** the airbag for a rear-facing child seat.

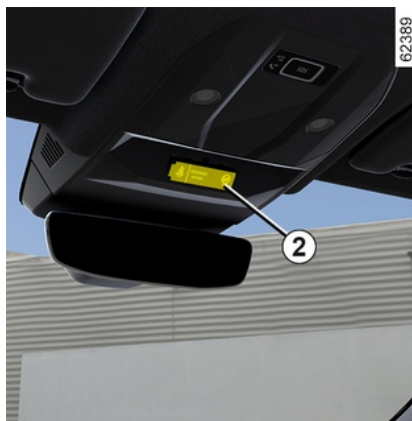

To deactivate the airbag: with the vehicle stationary and the ignition switched off, push and turn the lock 1 to the OFF position.

When the ignition is switched on, you

must check that the  warning light is illuminated on the display 2.

This light remains continuously lit to let you know that you can fit a child seat.



The passenger airbag may only be activated or deactivated when the vehicle is stationary

with the ignition off.

If it is interfered with when the vehicle is being driven, indicator

lights  and  will come on.

Switch the ignition off then on again to reset the airbag in accordance with the lock position.



DANGER

As the deployment of the front passenger airbag is not compatible with the positioning of a rear-facing child seat, **NEVER fit a rear-facing child restraint system on a seat protected by an ACTIVATED front airbag. This can cause the CHILD'S DEATH or SERIOUS INJURY.**

2

CHILD SAFETY: DEACTIVATING, ACTIVATING THE FRONT PASSENGER AIRBAG

2



62390



61614

Activation of the front passenger airbag



62396

You should reactivate the airbag as soon as you remove the child seat from the front passenger seat to ensure the protection of the front passenger in the event of an impact.



DANGER

As the deployment of the front passenger airbag is not compatible with the positioning of a rear-facing child seat, **NEVER fit a rear-facing child restraint system on a seat protected by an ACTIVATED front airbag. This can cause the CHILD'S DEATH or SERIOUS INJURY.**

CHILD SAFETY: DEACTIVATING, ACTIVATING THE FRONT PASSENGER AIRBAG

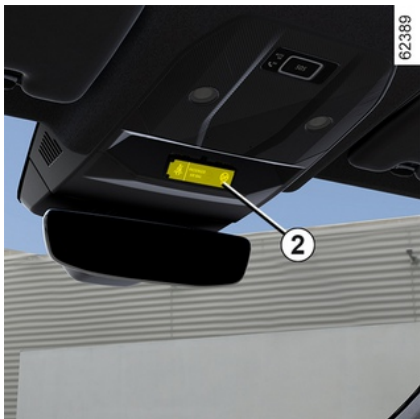

To reactivate the airbag: with the vehicle stationary and the ignition off, push and turn the lock **1** to the ON position.

When the ignition is switched on, you

must check that the  warning

light is off and that the  warning light lights up on the display **2** after each start-up for around 1 minute.

The front passenger airbag is activated.

Operating faults

In the event of a front passenger airbag a rear-facing child seat must not

be installed in the front passenger seat.

Allowing any other passenger to sit in that seat is not recommended.

Contact your approved Dealer as soon as possible;



Activation or deactivation of the passenger airbag must be carried out

while the vehicle is stationary and the ignition is off.

If it is interfered with when the vehicle is being driven, the warning

lights  and  will be displayed.

To restore the status of the airbag according to the position of the lock, switch off the ignition and then switch it back on.

DRIVING POSITION

Driving position: left-hand drive

2

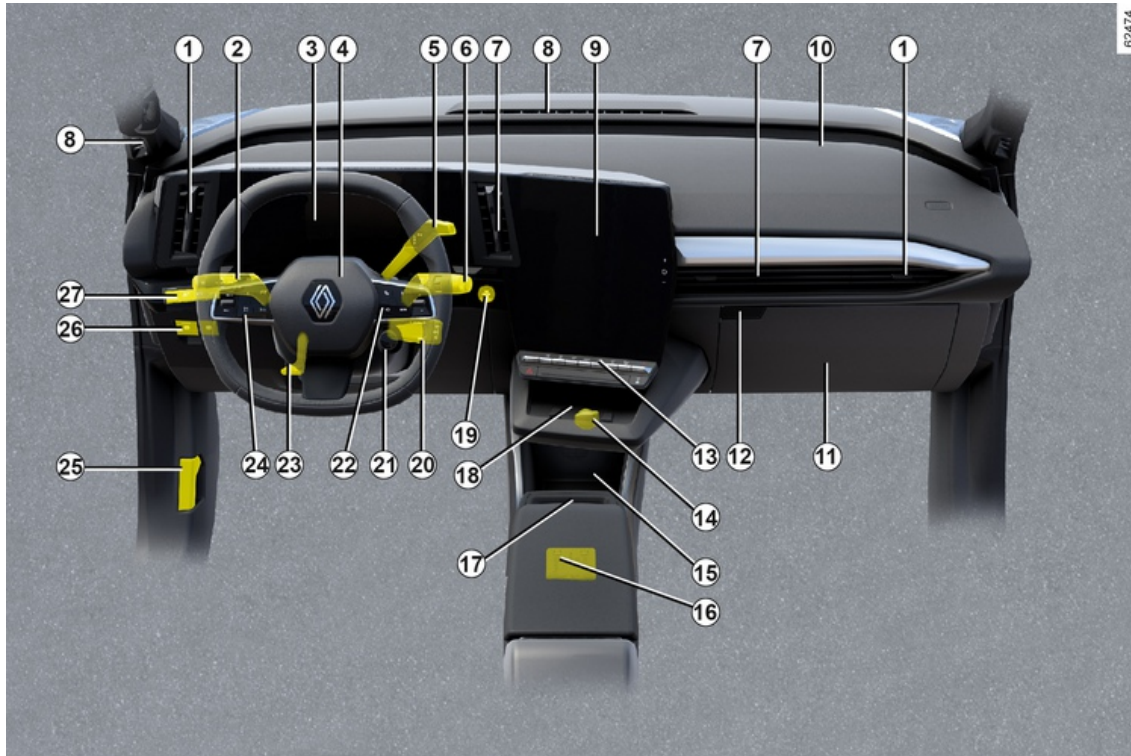

DRIVING POSITION

The fittings described below DEPEND ON THE VEHICLE VERSION AND COUNTRY.

1. Side air vents.

2. Stalk for:

- direction indicator lights;
- exterior lights;
- rear fog lights.

3. Instrument panel.

4. Driver airbag and horn location.

5. Electronic selector lever.

6. Steering column stalk for wind-screen and rear screen wash/wiper.

7. Centre air vents.

8. Demister outlet.

9. Multimedia screen.

10. Location of the airbag passenger.

11. Fuse box.

12. Glovebox

13. Controls for:

- heating or air conditioning;
- hazard warning lights;
- door central locking;
- ...

14. Accessories socket.

15. Cup holder.

16. USB-C ports in the centre console.

17. "Hands-free" card holder.

18. Induction charging zone or centre console storage compartment.

19. Engine start/stop button.

20. Radio remote control.

21. MULTI-SENSE control.

22. Controls for:

- trip computer information read-out and vehicle settings customisation menu;
- remote radio and navigation system.

23. Control for adjusting steering wheel height and reach.

24. Main switch and controls for the speed limiter/adaptive cruise control Stop and Go Active Driver Assist functions.

25. Bonnet release control.

26. Controls for:

- activating/deactivating the electronic parking brake;
- activating/deactivating the AUTOHOLD function;
- ...

27. Controls for:

- lighting dimmer for control instruments;
- the "My Safety" function
- luggage compartment opening control;
- ...

DRIVING POSITION

Driver's position, right-hand drive

2

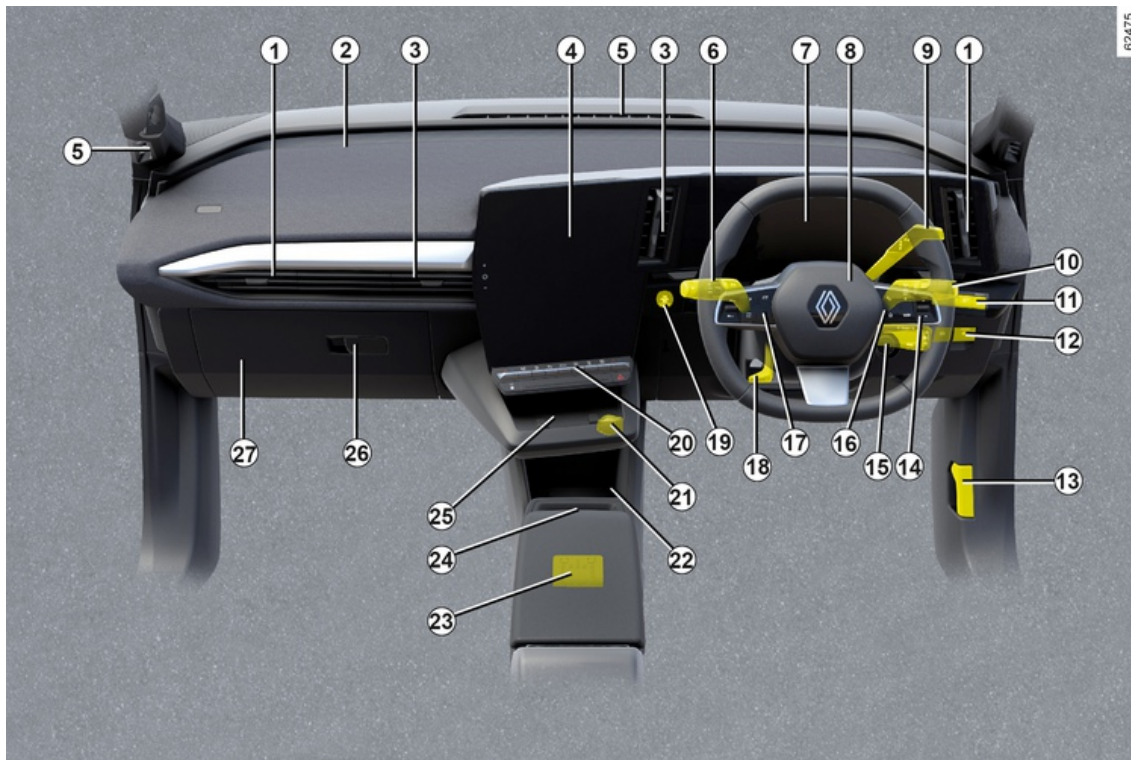

DRIVING POSITION

The fittings described below DEPEND ON THE VEHICLE VERSION AND COUNTRY.

1. Side air vents.
2. Location of the airbag passenger.
3. Centre air vents.
4. Multimedia screen.
5. Demister outlets.
6. Stalk for:
 - direction indicator lights;
 - exterior lights;
 - rear fog lights.

7. Instrument panel.
8. Driver airbag and horn location.
9. Electronic selector lever.
10. Steering column stalk for wind-screen and rear screen wash/wiper.
11. Controls for:
 - lighting dimmer for control instruments;
 - the "My Safety" function
 - luggage compartment opening control;
 - ...

12. Controls for:
 - activating/deactivating the electronic parking brake;

- activating/deactivating the AUTOHOLD function;
 - ...
13. Bonnet release control.
 14. Radio remote control.
 15. MULTI-SENSE control.
 16. Controls for:
 - trip computer information read-out and vehicle settings customisation menu;
 - remote radio and navigation system.

17. Main switch and controls for the speed limiter/adaptive cruise control Stop and Go Active Driver Assist functions.

18. Control for adjusting steering wheel height and reach.

19. Engine start/stop button.

20. Controls for:
- heating or air conditioning;
 - hazard warning lights;
 - door central locking;
 - ...

21. Accessories socket.

22. Cup holder.

23. USB-C ports in the centre console.

24. "Hands-free" card holder.

25. Induction charging zone or centre console storage compartment.

26. Glovebox

27. Fuse box.



TRIP COMPUTER

General information

2 Trip computer and warning system A



Depending on the vehicle, this includes the following functions:

- mileage;
- trip settings;
- information messages;
- operating fault messages (associated with the  warning light);
- warning messages (connected to the  warning light).

All these functions are detailed in the vehicle user manual.

Repeatedly press upwards/downwards on the switch **1** to browse between these functions.

From the instrument panel A :

a) trip settings:

- average energy consumption since the last reset and current energy consumption;
- distance travelled since last reset.

b) reset the pressure of the tyres;

c) service interval;

d) trip log, operating faults and information messages.

Resetting the journey parameters (reset button)

With one of the trip parameters selected as the display, press and hold the switch **1** downwards until the display resets to zero.

Automatic resetting of the journey parameters

Resetting occurs automatically when the maximum value of any of the parameters is exceeded.

Reading energy consumption values

Some vehicle equipment items consume energy: the energy consumed by the vehicle may therefore differ from

the energy consumed on the electric counter.

Interpreting some of the values displayed after resetting

The values showing average energy consumption and range will become more stable and reliable the further you have travelled since the last time the Reset button was pressed.

For the first few miles after pressing the reset key you will notice that the range increases as you travel. This is because the average energy consumption since the last reset is taken into account. However, the average energy consumption may fall when:

- the vehicle stops accelerating;
- when driving from an urban area onto the open road.



Some on-board computer information appears on the navigation system display.

The trip settings mileage recorder is reset simultaneously in the on-board computer and the navigation system.

TRIP COMPUTER

Resetting the estimated range

After the traction battery has been fully recharged, you can select two types of resetting: manual or automatic.

Manual reset

Select the trip setting to reset, then press and hold the switch **1** to reset the range.

Automatic reset



The range is automatically reset when the traction battery is fully charged. The calculated value corresponds to an average use, taking into account the exterior temperature. If a particularly economical driving pattern is identified, the calculation is corrected and the range is increased.

TRIP COMPUTER

Journey settings

2

The display of information shown below **DEPENDS ON THE VEHICLE EQUIPMENT AND COUNTRY**

Examples of selections	Interpreting the display selected
	a) Trip settings.
 + 13,4 kWh	Current energy consumption. Average energy consumption. The value is displayed after having travelled at least 400 metres since the last reset.
 12,8 kWh/100 km	
Journey 1284,7 km	
Tyre pressure init. long press	b) Reset the pressure of the tyres → 187

Examples of selections	Interpreting the display selected
Service in 1,200 miles (1,936 km) or 3 months	c) Service interval. Distance remaining until the next service (displayed in miles or kilometres), then when the service nears, several scenarios are possible: – interval less than 932 miles (1,500 km) or one month : the "Service in" message is displayed along with the remaining distance or time;

TRIP COMPUTER

Examples of selections	Interpreting the display selected
	<p>– when a service is due, the "Service due" message is displayed accompanied by the first limit (distance or time);</p> <p>– range equal to 0 miles (0 km) or date of service reached: the message "Service Required" is displayed accompanied by the  warning light. The vehicle requires a service as soon as possible.</p>
<p>Resetting the display after the service in accordance with the maintenance schedule.</p> <p>The service interval must only be reset after a service which complies with the recommendations in the maintenance schedule.</p> <p>Special feature: to reset the service interval, press and hold one of the display reset buttons for approximately 10 seconds until the display shows the service range permanently.</p>	
Examples of selections	Interpreting the display selected
Settings Press "OK"	<p>d) Vehicle settings customisation menu.</p> <p>→ 136</p>
WARNING: Boot Open	<p>e) Trip log.</p> <p>Successive display:</p> <ul style="list-style-type: none"> – information messages; – operating fault messages.

TRIP COMPUTER

Information messages

These can help in the vehicle starting phase, or give information about a selection or a driving status.

Examples of information messages are given in the following pages.

Examples of messages	Interpreting the display selected
"Disconnect the cable to start"	Indicates that the charging cable is still plugged into the vehicle.
"Check the connections"	Unplug, then plug in the vehicle.
"Check the charging terminal"	If the message still shows, this may be caused by the external charging conditions or by the home installation.
"Check the charging terminal"	Indicates a possible electrical fault or a defective charging cable: change the charging terminal or location or have the cable checked.
"Power cut off during charging"	Indicates an electrical fault while charging. Restart charging.
	If this does not work, have the electrical installation checked.

TRIP COMPUTER

Operating fault messages

They appear along with the  warning light and indicate that you should drive very carefully to an approved dealer as soon as possible. If you fail to follow this recommendation, you risk damaging your vehicle.

They disappear when the display selection key is pressed or after several seconds and are stored in the computer log. The warning light  remains on. Examples of operating fault messages are given in the following pages.

Examples of messages	Interpreting the display selected
"Check airbag"	Indicates a fault in the restraint system in addition to the seat belts. In the event of an accident, it is possible that they may not be triggered.
"Check vehicle"	Indicates a fault on one of the pedal sensors or in the secondary 12 V battery management system.
"Check braking system"	Indicates wear or the need to check the braking system.
"Check Post-collision"	Indicates a problem with the multi-collision braking.
"Check vehicle socket"	Indicates overheating at the vehicle-side charging socket. Wait for approximately 20 minutes then try again. If this does not work, contact an approved dealer.
"Check electrical system"	Indicates a fault in the traction system.
"Battery charging impossible"	Indicates a fault on the traction battery recharge system.

TRIP COMPUTER

Warning messages

2

They appear along with the **STOP** warning light and indicate that for your own safety you must stop immediately, as soon as traffic conditions allow. Stop your engine and do not restart it. Call an approved Dealer.

Some examples of warning messages are given below. **Note:** the messages appear on the display either individually or alternately (when there are several messages to be displayed), and may be accompanied by a warning light and/or a beep.

Examples of messages	Interpreting the display selected
"Braking system fault"	Indicates a fault in the braking system.
"Steering fault"	Indicates a fault in the steering system.
"Electric engine fault"	Indicates that the vehicle is losing power.
"Electrical fault"	Indicates a fault in the electric system.
"Puncture"	Indicates that at least one tyre is punctured or severely underinflated.



If the vehicle is parked on the hard shoulder, you must warn other road users of your vehicle's presence with a warning triangle or with other devices as per the legislation applying to the country you are in.

TRIP COMPUTER

Displays and indicators

Instrument panel A



lights up when the driver's door is opened. In some cases, the appearance of a warning light is accompanied by a message.

Selection of views

Depending on the vehicle, several views may be available on the instrument panel. To select a view, press control **1** as many times as necessary to scroll through the different views on the instrument panel **A** until you reach the desired view.

All of the available views display the following essential information on the instrument panel:

- speedometer;
- the information on the activated driving aids;
- information area.

Only while the vehicle is charging, the **"Charge"** view displays the range, the battery percentage and the remaining charging time on the instrument panel.

The **"Driving aids"** view displays the essential information on the instrument panel with that of the active driving aids in full screen.

The **"Classic"** view displays the essential information on the instrument panel and, depending on the vehicle, the power meter.

The **"Navigation"** view displays the essential information and the road map duplicated from the multimedia system on the entire instrument panel.

The **"Realist"** view **B**

617292



View **B** displays the essential information on the instrument panel, along with your vehicle and its environment (lanes, surrounding vehicles moving in the same direction, etc.).

Note: the system only recognises vehicles in the car, lorry and motorbike categories.

The **"Minimal"** view displays only the essential information on the dashboard.

TRIP COMPUTER

Information display

2



62494



63513

Speedometer 2.

The vehicle speed is limited to approximately 93 mph (150 km/h) (or 106 mph (170 km/h) depending on the vehicle).

Excessive speed audible alarm

Depending on the vehicle and country, the  warning light is displayed and a beep sounds. This beep sounds as soon as the vehicle is travelling at over 75 mph (120 km/h).

This warning light remains lit for as long as the vehicle is travelling at over 75 mph (120 km/h).

Information on driving aids 3.

Navigation in progress information 4.

Power meter 5.

Total mileage recorder 6.

Regenerative braking level warning light 8.

Battery information 9 (traction battery charging rate, estimated range).



62410

Information area 7, browse using the control **10** to select various widgets on the instrument panel **A**:

- trip computer information (mileage recorder, consumption, etc.);
- telephone, multimedia (audio source currently playing, etc.) information;
- vehicle information (warning messages, etc.);
- ...

TRIP COMPUTER

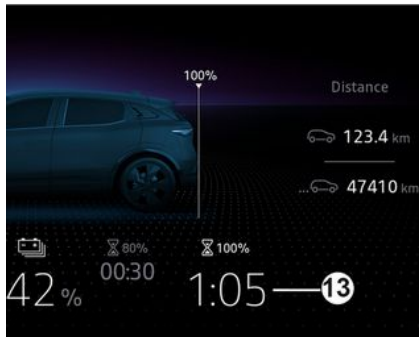
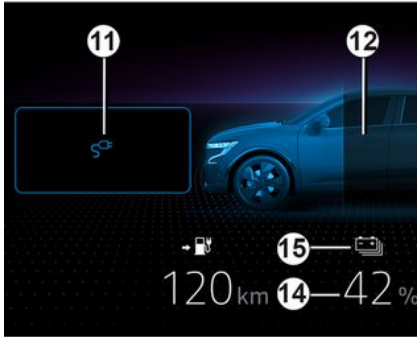

Charging lead "Plugged in" warning light 11

This comes on when the charging cable is plugged into the vehicle.

Charge level 12

The gauge indicates the level of energy remaining.

Remaining charging time 13

Traction battery charge rate 14

Reserve threshold

Depending on the vehicle, when the traction battery charge reaches approximately 7% or 12%, the meter and

the warning light 15  appear in yellow accompanied by a beep.

To optimise your range → 185.

Immobilisation threshold imminent

Depending on the vehicle, when the charge level reaches approximately 4% or 6%, a beep will sound again and the meter will light up in red or, depending on the vehicle, 30 seconds after the meter lights up in red.

Depending on the vehicle, when the charge level reaches 3.5% or approximately 5%, the range value is no longer displayed. Engine performance gradually decreases until the vehicle comes to a halt → 353.

Estimated range 16

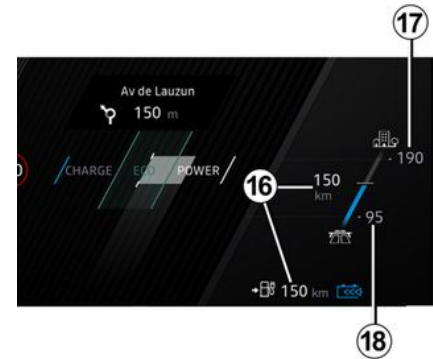

High 17: visibility of range in optimal conditions (e.g. driving on A-roads or dual carriageways with little use of thermal comfort).

Low 18: visibility of range in adverse conditions (e.g. driving on a motorway in winter or in a traffic jam with intensive use of thermal comfort).

To optimise your range → 185.

TRIP COMPUTER

Instrument panel in miles



(option to switch to km/h)

With the vehicle stationary and the engine running, from the multimedia screen **16** select the "Vehicle" world, press the "Settings" menu, "System", "Units" then "Speed".

Choose between km/h or mph.

The speedometer and some of the distance information displayed on the instrument panel are converted.

To return to the previous mode, repeat the same operation.

Note: once the battery is switched off, the trip computer automatically returns to the original unit of measurement.

Please refer to the multimedia instructions for more information.



To use certain driving aid functions, it is necessary to change the unit of measurement on the instrument panel in order to obtain the appropriate information when driving in a country where the speed units differ from those set as default on your vehicle.



For safety reasons, carry out any adjustments while the vehicle is stationary.

Vehicle settings personalisation menu



Depending on the vehicle equipment, this function allows you to activate/deactivate and adjust some of the vehicle's functions.

Accessing the settings menu

With the vehicle stationary and the engine on, from the multimedia screen **1** select the "Vehicle" world, press the "Vehicle" menu then the "Exterior" tab to access the various settings.

TRIP COMPUTER

Adjusting the settings

Select a tab then the function to be modified (the display depends on the vehicle equipment and country):

a) "Access":

- « Auto door lock while driving » ;
- « Hands-free lock/unlock » ;
- « Access and start by phone » ;
- ...

b) "Welcome":

- « External lighting sequence » ;
- « Internal sequence sound » ;
- « Automatic mirrors' unfolding » ;
- « Internal light function » ;
- ...

c) "Driving lights":

- « Adaptive Vision » ;
- « Driving side selection » ;
- ...

d) "Wiping":

- « Rear wiper when in reverse gear » ;
- « Automatic front wiper » ;
- ...

Depending on the function, select:

- "ON" or "OFF" to activate or deactivate;

or

- a time period to adjust the time during which the headlights are illuminated;

ed (e.g. for the "Follow me home" function).

Please refer to the multimedia instructions for further information.



For safety reasons, carry out any adjustments while the vehicle is stationary.

"Favourites" function



Depending on the vehicle, by pressing the steering wheel control **2** you can activate the following functions according to the stored user settings that you have previously defined:

- heated seats;
- heated steering wheel;
- setting selection (access, welcome, lighting, wiper, etc.);
- "Hands-free Park Assist" function;
- ECO mode;
- 360° camera;
- ...

For more information on programming this function, please refer to the multimedia instructions.



For safety reasons, carry out any adjustments while the vehicle is stationary.

TRIP COMPUTER

Clock and outdoor temperature

Setting the time



The time and outdoor temperature are displayed on the multimedia screen **1**.

To adjust the time, from the multimedia screen **1** select the "Vehicle" world, press the "Settings" menu, then "Date and time".

You can access various settings:

- "Time format";
- "Select a time zone";
- "Set the time zone";
- ...

Please refer to the multimedia instructions for further information.

Exterior temperature indicator

Special feature:

When the outside temperature is between -3°C and $+3^{\circ}\text{C}$, the $^{\circ}\text{C}$ figures flash (this indicates a risk of ice formation).



If the power supply is cut (battery disconnected, supply wire cut, etc.), the clock must be reset.

We recommend that you do not adjust these settings while driving.



Exterior temperature indicator

As ice formation is related to climatic exposure, local air humidity and temperature, the external temperature alone is not sufficient to detect ice.

WARNING LIGHTS

The display of information shown below **DEPENDS ON THE VEHICLE EQUIPMENT AND COUNTRY.**



Instrument panel A: this lights up when the driver's door is opened. To adjust the dashboard brightness, refer to the multimedia instructions.

In some cases, the appearance of a warning light is accompanied by a message.



Warning light  means you should drive **very carefully to an authorised dealer as soon as possible.** If you fail to follow this recommendation, you risk damaging your vehicle.



For your own safety, the **STOP** warning light requires you to stop immediately, as soon as traffic conditions allow. Switch off the engine and do not restart it. Call an approved dealer.



If no lights or sounds are apparent, this indicates a fault in the instrument panel. This indicates that it is essential to stop immediately (as soon as traffic conditions allow). Ensure that the vehicle is correctly immobilised and contact an approved Dealer.



Side light tell-tale light



Dipped beam headlight tell-tale light



Main beam headlight tell-tale light



Automatic main beam headlight indicator light



Rear fog light tell-tale



Left-hand direction indicator tell-tale light



Right-hand direction indicator tell-tale light

WARNING LIGHTS



Bad weather warning light



"Adaptive Vision" lights malfunction warning light



Door status warning light



Electronic parking brake applied warning light → 177



"Autohold" system warning light



Pedestrian horn fault warning light



Driver and passenger front airbag fault warning light → 117



Low windscreen washer level warning light



Automatic wiping function warning light



Urgent stop warning light

This lights up when the ignition is switched on and goes out as soon as the engine is switched on. The warning light comes on with other warning lights and/or messages and is accom-

panied by a beep.

For your own safety, it requires you to stop immediately, as soon as traffic conditions allow. Switch off the engine and do not restart it.

Call an approved dealer.



Warning light

This lights up when the ignition is switched on and goes out as soon as the engine is switched on. The warning light may light up in conjunction with other warning lights and/or messages on the instrument panel.

It means you should **drive very carefully** to an approved Dealer as soon as possible. If you fail to follow this recommendation, you risk damaging your vehicle.



Warning light

If it appears in red during driving and is

accompanied by the **STOP** indicator light, you must, for your safety, stop as soon as traffic conditions allow. Switch off the engine and do not restart it. Call an approved dealer.

If it appears in yellow during driving

and is accompanied by the 

warning light, visit an approved dealer as soon as possible. **Meanwhile, drive with care.** If you fail to follow this

recommendation, you risk damaging your vehicle.



Electrotechnical system warning light

It lights up along with the warning light



and a beep when the electrical assembly temperature is too high. Stop the vehicle and switch off the ignition. Consult an approved Dealer.

If it lights up accompanied by the

warning light  , a beep and the "EVACUATE IN SAFETY" message, switch off the ignition and do not restart the engine. Leave the vehicle and consult an approved dealer.

WARNING LIGHTS



The "EVACUATE IN SAFETY" message accompanied by the warn-

ing light **STOP** and a beep requires that you stop the vehicle immediately, depending on the traffic conditions. Switch off the ignition. Leave it switched off. Exit the vehicle, get all passengers out of the vehicle and keep them away from the vehicle and traffic.

Fire hazards



If the vehicle is parked on the hard shoulder, you must warn other road users of your vehicle's presence with a warning triangle or with other devices as per the legislation applying to the country you are in.



Electrotechnical system fault warning light

When it comes on, this indicates an electrotechnical fault related to the

electrical assembly (traction battery and electric motor). Contact your approved Dealer straight away.



Electric motor fault warning light

When it comes on, this indicates a fault with the electrotechnical system linked to the electric motor. Contact your approved Dealer straight away.



Traction battery gauge warning light

This appears in yellow when the traction battery charge level has reached the reserve threshold.



Traction battery fault warning light

If it appears, accompanied by the



warning light, this indicates a fault related to the operation of the traction battery. Contact your approved Dealer straight away.



Secondary 12 V battery charge warning light

If it comes on, accompanied by the

warning light **STOP** and a beep, this means that the electrical circuit is over-charged or discharged → **338**.



Limited performance warning light

This appears when the traction battery temporarily does not deliver its nominal power. During this period, vehicle performance is reduced.

Opt for a smoother driving style until the warning light disappears.



Charging cord plugged in warning light

This lights up when the charging lead is plugged into the vehicle → **20**.



Anti-lock braking warning light

This lights up when the ignition is switched on and goes out after a few seconds.

If it does not go out after the ignition is switched on, or lights up when driving, there is a fault with the ABS. Braking will then be as normal, without the ABS. Contact your approved Dealer straight away.



Electronic Stability Program (ESC) and traction control system warning light

The warning light may appear for several reasons.

WARNING LIGHTS



Electronic Stability Program (ESC) and traction control system unavailability warning light



Tyre under-inflation warning light

This lights up when the ignition is switched on or when the engine starts, then disappears after a few seconds
→ 187.



"Hands-free parking" function warning light



Variable power assisted steering warning light

It lights up when the ignition or the engine is switched on and goes off after a few seconds.

If it comes on while driving, alongside

the warning light **STOP**, this means there is a system fault.
Call an approved dealer.



Brake circuit fault warning light

It lights up when the ignition or the engine is switched on and goes off after a few seconds.

If it comes on during braking and is ac-

companied by the **STOP** warning

light and a beep, it indicates that the fluid level in the circuit is low or that there is a braking system fault.
Stop as soon as traffic conditions allow and consult an approved Dealer.



Brake pedal warning light

This lights up when the brake pedal should be depressed.



Charging programming warning light



Air conditioning programming indicator



"Hands off steering wheel" detection warning light



"Advanced safety" function fault or unavailability warning light



Overspeed warning light



Lane departure system warning light



Lane departure prevention system warning light



Lane centring system warning light



Speed limiter warning light



Adaptive cruise control warning light Stop and Go

On display **B**



Passenger Airbag ON → 117



Passenger Airbag OFF → 117



Front seat belt reminder warning light

On the rear view mirror **C**
(depending on the vehicle)

WARNING LIGHTS



 **Camera rear view function
warning light → 148**

STEERING

Steering wheel

2 Adjusting the steering wheel height and depth



Lower the lever **1** and set the steering wheel to the required position.

Then, raise the lever fully, beyond the point of resistance to lock the steering wheel.

Make sure that the steering wheel is correctly locked.



For safety reasons, only adjust the steering wheel when the vehicle is stationary.

Steering wheel heating

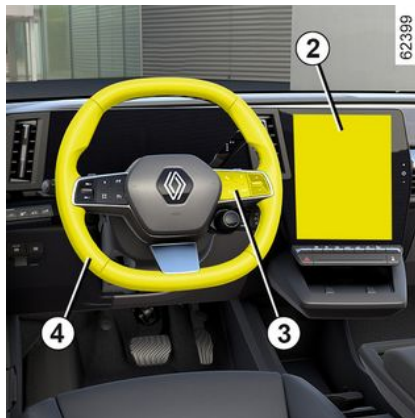

(depending on the vehicle)

This function heats the steering wheel **4**.

Operating principle

When the temperature is reached, the function regulates the temperature of the heated areas for approximately 30 minutes and then switches off automatically.

Activating the function

With the ignition on, press the button **5** on the multimedia screen **2**.

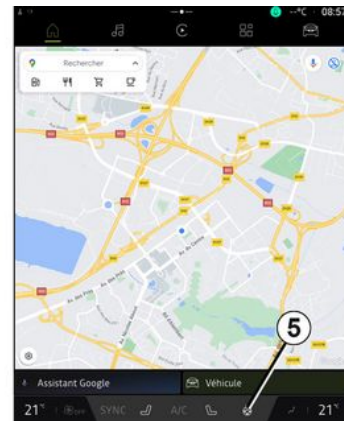

Deactivating the function

– Automatically:

The function switches off automatically after the regulation phase of approximately 30 minutes.

– Manually:

To deactivate the function during the regulation phase, press the button **5** on the multimedia screen **2**.

Note: the function can also be accessed using the **3** "Favourites" button on the steering wheel **4**.

STEERING

"Favourites" function



Depending on the vehicle, by pressing the steering wheel control **6** you can activate the heated steering wheel according to the stored use settings that you have previously defined.

For more information on programming this function, please refer to the multimedia instructions.

Power-assisted steering

The variable power-assisted steering system is equipped with an electronic control system which alters the level of assistance to suit the vehicle speed.

Steering is made easier during parking manoeuvres (for added comfort) while

the force needed to steer increases progressively as the speed rises (for enhanced safety at high speeds).



Never switch off the ignition when travelling downhill, and avoid doing so in normal driving (power steering and brake servo will not function).



Never leave the steering wheel on full lock when the vehicle is stationary. With the engine switched off, or if there is a system fault, it is still possible to turn the steering wheel. The force required will be greater. A noise may be heard when the steering wheel is moved quickly. This is normal.

REAR VIEW

Rear view mirrors

2

Exterior rear view mirrors with electrical adjustment:

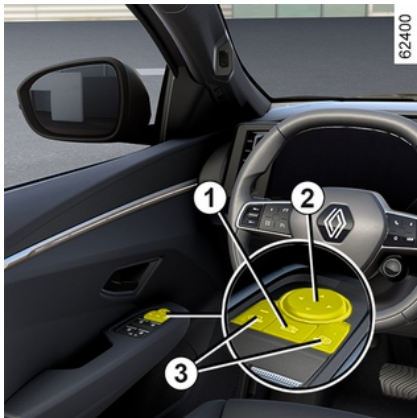

Select the door mirror using one of the switches **3**, then use the switch **2** to adjust it to the desired position.

Heated rear view mirrors

While the engine is running, mirror de-icing is activated simultaneously with the rear screen de-icing/demisting.



For safety reasons, carry out any adjustments while the vehicle is stationary.

Electrical folding mirrors

The door mirrors will fold-out automatically when the vehicle is unlocked. The door mirrors fold in when the vehicle is locked.

You can deactivate/activate automatic folding of the door mirrors → **136**.

You can force folding by pressing the switch **1**. In this situation, the door mirrors will remain folded until the **1** button is pressed again, regardless of automatic folding.

Special case

When the rear view mirror has been manually deployed or folded back, it is possible to reset it to a usage position.

To do this, press the switch **1**. A mechanical noise from the rear view mirror unit will be heard.

If a tapping noise cannot be heard, press the switch **1** again until the tapping noise can be heard from the door mirror.



Objects observed in the rear view mirror glass are actually closer than they appear.

For your safety, take this into account in order to correctly assess the distance before any manoeuvre.

Rear view mirrors which tilt in reverse gear

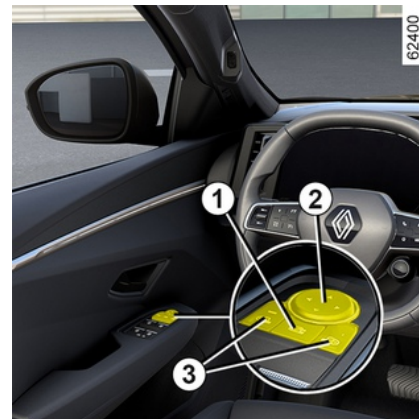

For vehicles equipped with the driver's seat with position memory, you can enter a specific setting for the rear view mirrors when reversing and store the position.

REAR VIEW

With the vehicle at a standstill and reverse gear engaged, select the door mirror using one of the switches **3**, then use the switch **2** to adjust it to the required position.

Returning to the driving position

It is possible to move from the reverse gear to a forward gear:

- approximately nine seconds after the reverse gear has been disengaged when the speed is lower than 6 mph (10 km/h);
- with the forward gear engaged when the speed is greater than 6 mph (10 km/h);
- when the engine is stopped.

Position memory

- Adjust the door mirrors (see previous paragraphs);
- refer to the multimedia instructions to access the settings memory. Save the settings.

The positions of the exterior rear view mirrors in forward and reverse gear, and the position of the driver's seat are saved simultaneously.

Recalling the memorised position

Refer to the multimedia manual to access recall of the saved position. Select "Recall".

The positions of the exterior rear view mirrors in forward gear, reverse and of the front seats are recalled.



For safety reasons, carry out any adjustments while the vehicle is stationary.

Interior rear view mirror

Its position can be adjusted.

Rear view mirror with lever 4

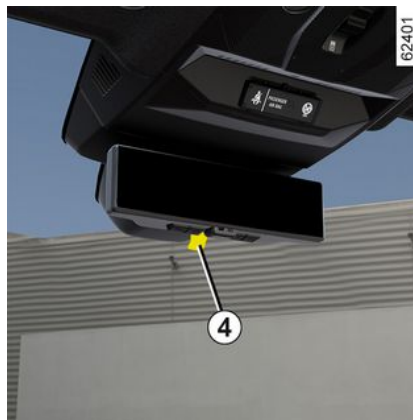

When driving at night, to avoid being dazzled by the headlights of the vehi-

cle behind, shift the small lever **4** located behind the rear view mirror.

Rear view mirror with lever 5

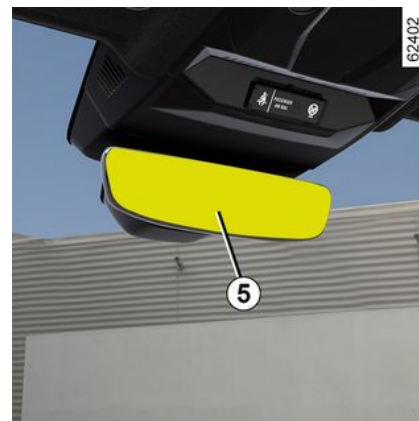

The rear view mirror automatically darkens when you are being followed by a vehicle using main beam headlights or in very bright lighting.

Camera rear view

Depending on the vehicle, your rear view mirror may be fitted with a display of the rear surroundings transmitted by the camera fitted behind the rear screen.

For more information → **148**.

REAR VIEW

Camera rear view

Operating principle

2



Depending on the vehicle, the rear view may be displayed by the camera **1**.

Direct rear view by mirror remains available at all times.

The camera **1** is fitted behind the rear screen, in the wiping area.

Make sure that the camera **1** is not obscured (by dirt, mud, snow, condensation, etc.).



When the ignition is switched on, the rear view mirror **2** mounted on the roof centre console displays the view behind the vehicle that is transmitted by the camera **1**.

Note:

– the camera display **1** is transmitted only if the rear view mirror is in "screen" mode.



This function is an additional aid. It cannot, therefore, under any circumstances replace the vigilance or the responsibility of the driver.

The driver should always be ready for sudden incidents while driving: always ensure that there are no small, narrow moving obstacles (such as a child, animal, pushchair, bicycle, stone, post, etc.) in the blind spot when manoeuvring.

Adjusting the rear view mirror 2

If reflections reduce the visibility of the view transmitted by the camera, you can adjust the rear view mirror **2** to the left, right, upwards or downwards.

REAR VIEW

Operation

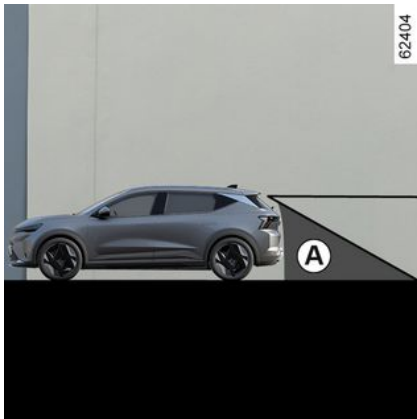

The camera's field of vision does not cover the entire area behind the vehicle, especially in the blind spot area **A**.

Switching off the function

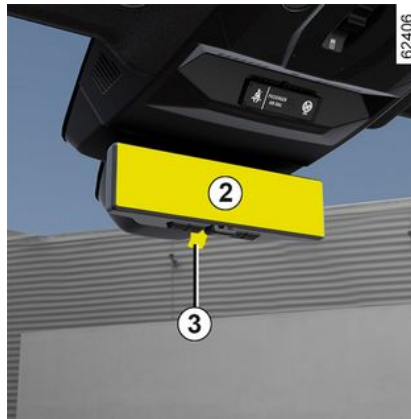

The display switches off immediately after the ignition is switched off.

Note: the "mirror" mode can be activated using the lever **3**.

 Depending on your vision, an adaptation time may be necessary to focus on the camera view display. Objects which appear on the edge of the door mirror **2** may be distorted. In very bright light (snow, vehicle in sunshine, etc.), the camera view may be partially disturbed. In low brightness or poor weather, the image on the screen may be distorted.

Operation

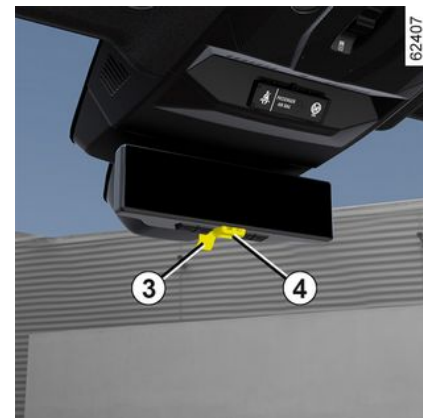

REAR VIEW

Use the lever **3** to switch between "mirror" mode and "screen" mode.

The green LED **4** as well as the pictogram displayed at the top right of the rear view mirror indicates that the screen mode is operating properly.

It disappears if you switch to "mirror" mode or in the event of a fault.



Each time the vehicle is started, the function returns to the settings saved at the last engine stop.

Adjusting the display and the camera

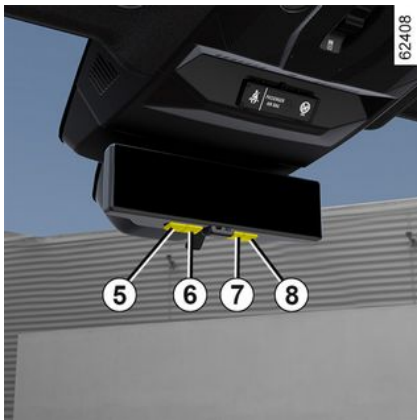

Press button **5** for "**Menu**" to access the settings menu.

Repeatedly press buttons **6** and **7** to scroll through the settings options. Press the "OK" button **8** to access the desired setting.

Use buttons **6** and **7** to adjust or activate/deactivate the desired setting.

Selecting the settings:

- a) adjusting the brightness;
- b) adjusting the vertical viewing angle;
- c) adjusting the horizontal viewing angle;
- d) adjusting the angle of rotation;
- e) activating/deactivating the settings menu display on the rear view mirror;
- f) selecting a language;
- g) activating/deactivating button backlighting.

Exit from the settings menu occurs automatically after approximately five seconds if no button is pressed.



For safety reasons, carry out any adjustments while the vehicle is stationary.

Adjust the system field of vision and the door mirrors before driving. Be sure to adjust the central rear view mirror before switching to "screen" mode.

Special features related to the reverse gear



When the vehicle is reversing, pay attention to the images transmitted by the reversing camera (multimedia

REAR VIEW

screen **9**) in addition to the information available through the rear view mirror → **278** as there remains a rear view blind spot.

Operating faults

When the system detects an operating fault, the rear view mirror **2** turns

black, the pictogram  displayed at the top right of the rear view mirror disappears and the LED **4** goes out.

This may be caused by a fault affecting the camera or screen (clearness, fixed image, delayed communication etc.).

If the black background persists, switch to "mirror" mode and consult an approved dealer.

LIGHTING AND SIGNALS

Exterior lighting and signals

2 Daytime running lights



Rotate the ring **3** until the AUTO symbol is aligned with the mark **2**.

The daytime running lights come on automatically (without any action on the stalk **1**) when the engine is started and they switch off when the engine is switched off.

Side lights

 Turn the ring **3** until the symbol is opposite the mark **2**.

This indicator light on the instrument panel comes on.

Note: depending on the vehicle, the side lights can only be activated manually when the parking brake is applied or, depending on the vehicle, when the

gear lever is in the **P** position. Otherwise, the "Unavailable position lights" message is displayed on the instrument panel to inform you that it is not possible to activate the side lights.

Dipped beam headlights

Manual operation

Turn the ring **3** until the symbol is opposite the mark **2**.

This indicator light on the instrument panel comes on.



Before driving at night, check that the electrical equipment is operating correctly and adjust the headlight beams (if your vehicle is not carrying its normal load). As a general precaution, check that the lights are not obscured (by dirt, mud, snow or objects being transported).

Automatic operation

Turn the ring **3** until the AUTO symbol is opposite the mark **2**: with the engine on, the dipped beam headlights switch on or off automatically according to the

LIGHTING AND SIGNALS

exterior light level, without any action on the stalk **1**.

Depending on the vehicle, the dipped beam headlights will appear automatically after several sweeps of the wind-screen wiper blades.



When driving on the left-hand side of the road in a left-hand drive vehicle (or vice versa), you must adjust your headlights for the length of your stay → **156**.

Adaptive front lighting system

(depending on the vehicle)

This function automatically adjusts the width and range of the dipped beam headlights according to the speed and weather conditions.

Turn the ring **3** until the AUTO symbol is opposite the mark **2**: with the engine on.

This function can be deactivated, refer to the multimedia instructions.

Operating faults

When the "Check Automatic Lighting" message appears on the instrument panel, the system is deactivated.

Consult an approved Dealer.

"Poor weather" function



(depending on the vehicle)

This function is part of the adaptive front lighting system. It replaces the use of the front fog lights. It may be activated in foggy or snowy weather or in any other case of poor visibility.

To activate this function, turn the ring **3** until the AUTO symbol appears opposite the mark **2**, then press the rotary switch to bring the mark **4** in line with the symbol **5**.

Warning light  comes on the instrument panel.

Switching off the lights

To deactivate the function, rotate the rotary switch again so that the mark **4** is opposite the symbol **5**.

The warning light  disappears from the instrument panel.

The poor weather lights switch off when the exterior lights are switched off.

Additional cornering lighting

(depending on the vehicle)

In forward gear, if the dipped beam or main beam headlights are on and de-

pending on the steering wheel angle, this function adapts the beam width to improve visibility on a bend or at a junction.

Main beam headlights



 With the engine on and the dipped beam headlights on, push the stalk **1** (movement **A**).

This indicator light on the instrument panel comes on.

To return to the dipped beam headlights position, push the stalk **1** again.

LIGHTING AND SIGNALS

Automatic main beam headlights

2

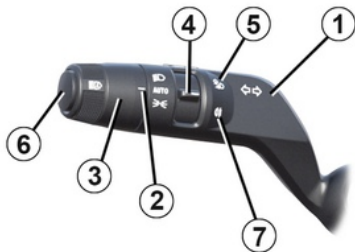

 Depending on the vehicle, this system switches the main beam headlights on and off automatically.

It uses a camera located behind the interior rear view mirror to detect vehicles that are being followed and those coming in the opposite direction.

Note: at night, in urban areas with street lighting, the automatic main beam headlights automatically switch off.

The main beam headlights come on automatically if:

- the exterior light level is low;

- no other vehicle or lighting is detected;
- the vehicle speed is above approximately 25 mph (40 km/h).

If any of the above conditions are not fulfilled, the system switches to dipped beam headlights.

Note: make sure that the windscreen is not obscured (dirt, mud, snow, condensation, etc.).

Activation/deactivation

To activate the automatic main beam headlights

Turn the ring **3** until the AUTO symbol is next to the mark **2**, then press the switch **6**.

The warning light  appears on the instrument panel if the dipped beam headlights are on.

To deactivate the automatic main beam headlights

Press the switch **6**, the  disappears from the instrument panel.

Note: push the stalk **1** to deactivate the automatic daytime running lights

function, the  will disappear from

the instrument panel and the main beam headlights will be activated.

 The system may encounter difficulties under certain conditions, including:

- extreme weather conditions (rain, snow, fog, etc.);
- obstruction in front of the windscreen or camera;
- when a following or oncoming vehicle has weak or hidden lighting;
- incorrect settings for the front headlights;
- reflecting systems;
- ...

Operating faults

If the "Check automatic lighting" message appears on the instrument panel, the system is deactivated.

Consult an approved dealer.

LIGHTING AND SIGNALS



Using a portable navigation system at night in the windscreen area below the camera may disturb the operation of the "automatic main beam headlights" system (risk of reflection on the windscreen).



The "automatic main beam headlights" system should under no circumstances be used to replace the driver's attention and responsibility with regard to vehicle lighting and adapting to light, visibility and traffic conditions.

Switching off the lights

The lights will go out automatically when the driver's door is opened or the vehicle is locked, or one minute after the engine is switched off.

In this case, the next time the engine is started the lights will be switched back on according to the position of the ring **3**.

Lights-on reminder buzzer

If the lights are on after the engine is switched off, a warning beep sounds when the driver's door is opened to warn you that the lights are still on.

Operating faults

Depending on the vehicle, if the "Check lighting" message appears

along with the  warning light

and/or the  warning flashes on the instrument panel, this indicates a lighting fault.

Consult an approved dealer.

Welcome and goodbye function

(depending on the vehicle)

Once the function is activated, the daytime running lights and the rear side lights will light up automatically upon detection of the card or when the vehicle is unlocked.

They switch off automatically:

- approximately fifteen seconds after they are switched on;
- when starting the engine, based on the position of the lighting stalk;
- or
- upon locking the vehicle.

Activating/deactivating the function

For activation or deactivation of the external welcome, refer to the multimedia instructions.

"See-me-home lighting"

This function enables you to briefly switch on the side lights and dipped beam headlights (e.g. to provide light when opening a gate).

With the engine stopped and the lights switched off, after opening the driver's door, the ring **3** in position AU-TO, pull the stalk **1** towards you: the side lights and dipped beam headlights will switch on for approximately 30 seconds along with the warning lights



on the instrument panel.

To increase this duration, you may pull the stalk up to four times (total time restricted to approximately two minutes).

The "Lighting on during ___" message appears with the lighting time on the instrument panel to confirm the action.

You can then lock your vehicle.

Deactivating the "See-me-home lighting" function

To switch off the lights before they switch off automatically, turn the ring **3**

LIGHTING AND SIGNALS

to any position, then return it to position AUTO.

Note: if the Welcome and Goodbye function is activated, once the engine is switched off, the procedure for deactivating the "See-me-home lighting" function must be carried out before pulling the stalk (otherwise the lights remain lit by the Welcome and Goodbye function).

Rear fog light

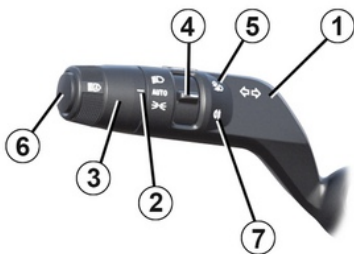

62413

 To activate this function, turn the ring **3** until the AUTO symbol appears opposite the mark **2**, then press the rotary switch to bring the mark **4** in line with the symbol **7**.

Warning light  comes on the instrument panel.

Operation of the fog lights depends on the exterior lighting selected, and an indicator light will light up on the instrument panel.

To avoid inconveniencing other road users, remember to switch off this light when it is no longer needed.

Switching off the lights

To deactivate the function, rotate the rotary switch again so that the mark **4** is opposite the symbol **7**.

The warning light  disappears from the instrument panel.

The rear fog lights switch off when the exterior lights are switched off.

 When driving in fog or snow, or when transporting objects which are higher than the roof, the headlights do not come on automatically. The fog lights are controlled by the driver: the warning lights on the instrument panel inform you whether they are on (warning light on) or off (warning light off).

Headlight beam adjustment



62415

Depending on the vehicle, the switch **A** can be used to adjust the height of

LIGHTING AND SIGNALS

the headlight beams according to the load.

With the dipped beam headlights on, press or raise switch **A** as many times as required to select the required position on the instrument panel. The position selected is displayed on the instrument panel for approximately 15 seconds.

Note: if the lights are on, at each engine start-up the selected position is displayed on the instrument panel for approximately 15 seconds.



When driving on the left in a left-hand drive vehicle (or vice versa), you must adjust your lights **temporarily** for the duration of your trip.

LIGHTING AND SIGNALS

Table of adjustment position examples

2

	Examples of positions for adjusting the control A according to the load
Driver alone or with front passenger	0
All seats occupied	1
Driver with passengers and luggage (or load) reaching the maximum permissible all-up weight	2
Driver without passengers and luggage (or load) reaching the maximum permissible all-up weight	3

The table below gives some examples. In all cases, adjust the control **A** according to the vehicle load so that the road can be seen and other drivers are not dazzled.

LIGHTING AND SIGNALS

Temporary adjustment

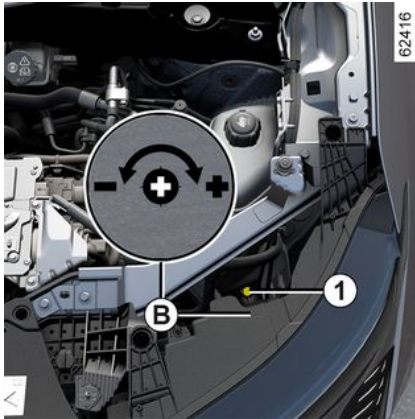

This can be adjusted using the multimedia screen → **136**.

Depending on the vehicle, the adjustment must be carried out manually.

Press or raise the switch **A** as many times as required to select position 0 on the instrument panel.

Open the bonnet and identify the marking **B** next to one of the front headlight projectors.

Using a screwdriver or similar, turn the screw **1** a half turn towards the - symbol to lower the beams.

Return to the original position once your trip is over: turn the screw **1** a

half turn towards the + symbol to raise the beams.

AUDIBLE AND VISUAL SIGNALS

Horn

2



Press the steering wheel boss **A** to sound the horn.

Headlight flasher

To flash the headlights, pull the stalk **1** towards you, then release.

Direction indicators

Move the stalk **1** in the same direction as you want to move the steering wheel.

One-touch mode

Briefly shift the stalk **1** upwards or downwards, not exceeding the point of resistance, then release it: the stalk

will return to its original position and the direction indicator light concerned will flash three times.

Hazard warning lights



 Press the switch **2**. This switch activates all four direction indicators and the side indicator lights simultaneously.

It must only be used in an emergency to warn drivers of other vehicles that you have had to stop in an area where stopping is prohibited or unexpected, or that you are obliged to drive under special conditions.

WIPER

Windscreen wash, wipe

Vehicle fitted with intermittent windscreen wipers

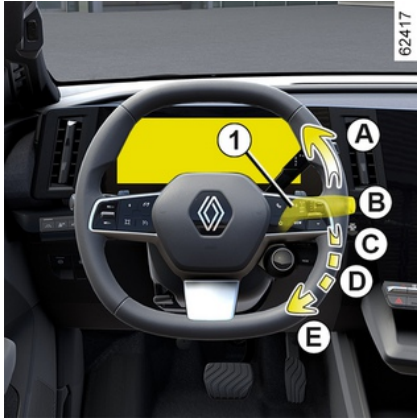

A. a single sweep of the wipers

A short push will trigger one sweep of the wipers.

B. stopping

C. intermittent wiping

The wipers will pause for several seconds between sweeps. It is possible to change the interval between sweeps by turning the ring 2.

D. slow continuous wiping

E. fast continuous wiping



Special feature

When driving the vehicle, the wiping speed slows down whenever the vehicle stops.

For example, fast wiping speed will slow to normal wiping speed.

As soon as the vehicle moves off, wiping will return to the speed originally selected.

Any action on the stalk 1 overrides and cancels the automatic function.

Vehicle fitted with front windscreen wiper rain sensor

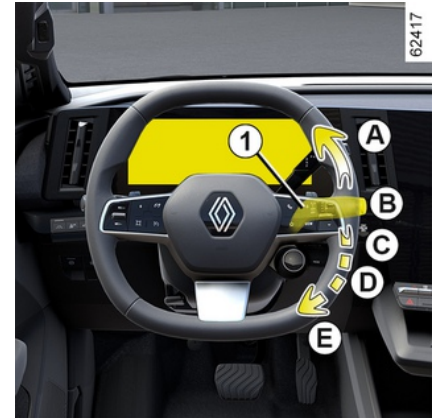

The rain sensor is located on the windscreen, in front of the interior rear view mirror.

A. a single sweep of the wipers

A short push will trigger one sweep of the wipers.

B. off



62418

C. automatic wiper function

When this position is selected, the system detects water on the windscreen and triggers the wipers at a suitable wiping speed.

It is possible to change the triggering threshold and the interval between sweeps by turning the ring **2**:

- **F**: maximum sensitivity;
- **G**: minimum sensitivity.

The higher the sensitivity, the quicker the wipers will react and the faster the wipe.

When activating automatic wiping or when increasing sensitivity, one sweep of the blades is performed.

The  warning light appears on the instrument panel to confirm that the function is activated.

Note:

- the rain sensor is only intended as a driving aid. In the event of reduced visibility, the driver should manually activate the wipers. In foggy weather or during snowfalls, wiping is not automatically triggered and remains under the driver's control;

- in the event of temperatures below zero, automatic wiping is not activated when the vehicle is started. It is automatically activated as soon as the vehicle exceeds a certain speed (approximately 5 mph (8 km/h));

- do not activate automatic wiping in dry weather;
- fully de-ice the windscreen before activating automatic wiping;
- when washing using a roller type car wash, return the stalk **1** to the off position **B** to deactivate automatic wiping.

Operating faults

In the event of a malfunction of the automatic wiping, the wiper is set to intermittent wiping. Call an approved dealer.

The rain sensor operation may be interrupted in the event of:

- damaged windscreen wipers: a film of water or traces left by a blade in the sensor's detection zone may increase the response time of the automatic wiper, or increase the wiping frequency;
- a windscreen with any chip or crack near the sensor, or a windscreen covered in dust, dirt, insects, ice, the use of washing wax and water-repellent chemicals. The windscreen wiper will be less sensitive or may even not react at all.

D. slow continuous wiping

E. fast continuous wiping

Special feature

When driving the vehicle, the wiping speed slows down whenever the vehicle stops.

For example, fast wiping speed will slow to normal wiping speed.

As soon as the vehicle moves off, wiping will return to the speed originally selected.

Any action on the stalk **1** overrides and cancels the automatic function.

Precautions

- In the event of ice, check whether the blades are stuck to the windscreen before operating the wiping mechanism. If you activate the wipers while the blades are stuck down with ice,

WIPER

you may risk damaging both the blade and the wiper motor.

- Do not activate the wipers on a dry screen. This will lead to premature wear or damage to the blades.

Specific front wiper position (service position)

This position enables the blades to be lifted to remove them from the windscreen.

It may be useful to:

- clean the blades;
- release the blades from the windscreen in winter;
- replace the blades → 359.

With the engine off or running, lift the stalk **1** twice to position **A** (single sweep).

The blades stop slightly away from the bonnet.

To return the blades to the lowered position, with the ignition on, ensure that the wipers have folded down onto the windscreen, then move the stalk **1** to position **A** (single sweep).

Before switching on the ignition, place the wipers on the windscreen. Otherwise, there may be a risk of damage to the bonnet or the wipers when they are switched on.



Before any action involving the windscreen (washing the vehicle, de-icing or cleaning the windscreen, etc.) return the stalk **1** to position **B** (park).

Risk of injury and/or damage.



In the event of obstacles on the windscreen (dirt, snow, ice etc.), clean the windscreen (including the central area located behind the interior rear view mirror) before starting the wipers (risk of motor overheating). If an object is preventing a blade from moving, it may stop functioning.

Remove the obstacle and reactivate the wiper using the wiper stalk.

Windscreen washer

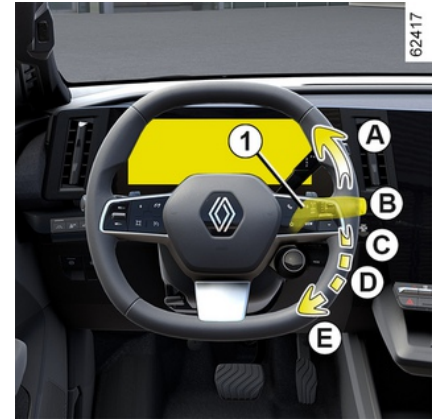

With the ignition on, pull the stalk **1** then release it.

A longer pull will trigger, in addition to the windscreen washer, two sweeps of the wipers followed, a few seconds later, by a third.

Note:

- A front washing action at stalk **1** lasting for more than 30 seconds may cause the windscreen washer pump to cut out. **This prevents the pump from overheating;**
- in temperatures below zero, the washer liquid risks freezing to the windscreen, thereby reducing visibility. Heat the windscreen using the demister control before cleaning.

WIPER

2



When working in the engine compartment, ensure that the windscreen wiper stalk is in position

B (stop).

Risk of injury.



Efficiency of a wiper blade

Check the condition of the wiper blades. How long they last depends on you:

- it must remain clean: clean the blade and the screen regularly with soapy water;
- do not use it when the screen is dry;
- free it from the screen when it has not been used for a long time.

In all cases, replace it as soon as it begins to lose efficiency: approximately once a year → **359**.

Precaution for using the wipers

- In freezing or snowy conditions, clear the screen before starting the wipers (risk of motor overheating);
- ensure that no objects are obstructing the travel of the blade.

Rear windscreen wash, wiper

Rear windscreen wiper



62476



With the ignition on, rotate the ring **3** on the stalk **1** until the symbol is opposite the mark **2**

- **off**;
- **intermittent wiping**;

The wipers will pause for several seconds between sweeps. The wiping frequency varies according to the vehicle speed;

- **slow continuous wiping**.

To stop the operation, rotate the ring **3** again.

WIPER

Note: when washing using a roller type car wash, return the ring **3** on the stalk **1** to the stop position to deactivate automatic wiping.

Follow usage recommendations.

At the end of use, remember to return the rear wiper control to the stop position, so that wiping is not inadvertently activated during the next use.



Do not use the wiper arm to open or close the tailgate.



Before taking any action involving the rear screen (washing the vehicle, de-icing, cleaning, etc.) return the stalk **1** to the off position.

Risk of injury and/or damage.



Efficiency of a wiper blade

Check the condition of the wiper blades. How long they last depends on you:

- it must remain clean: clean the blade and the screen regularly with soapy water;
- do not use it when the screen is dry;
- free it from the screen when it has not been used for a long time.

In all cases, replace it as soon as it begins to lose efficiency: approximately once a year ➔ **359**.

Precautions for using the wipers

- In freezing or snowy conditions, clear the screen before starting the wipers (risk of motor overheating);
- ensure that no objects are obstructing the travel of the blade.

Activation/deactivation of the rear screen wiper

Engaging reverse gear triggers intermittent wiping (if the front wipers are in operation). If your vehicle is equipped

with a vehicle settings customisation menu, you can opt to activate or deactivate this function ➔ **136**.

For vehicles not fitted with a settings customisation menu, you can have this function deactivated by an authorised dealer.

In the event of obstacles present on the rear window (dirt, snow, etc.), the wiper will try to sweep away all the obstacles. If an obstacle prevents the blade from moving, it can be stopped. Remove the obstacle, wait for around 30 seconds and reactivate the wiper using the wiper stalk.

Precautions

- In the event of ice, check that the blades are not stuck to the windscreen before operating the wipers. If you activate the wiper while the blade is blocked by ice, you risk damaging both the blade and the wiping motor.
- Do not operate the wipers on a dry screen. This will lead to the premature wear or damage to the blades.

Rear screen wash/wipe



With the ignition on, push and hold the stalk **1** then release it.

Holding the stalk for longer will trigger (in addition to the windscreen washer) two sweeps of the rear wiper followed,

WIPER

a few seconds later, by a third (drip wiping function).

When the stalk is released, it returns to the rear wipe position.

Note: a rear washing action at stalk **1** lasting for more than 30 seconds may cause the windscreen washer pump to cut out. **This prevents the pump from overheating.**

2

STARTING, STOPPING THE ENGINE

Starting the engine



The card must be in the detection zone **1**.

To start:

- press the brake pedal;
- press the button **2**. The message READY appears on the instrument panel, along with a beep.

The message disappears when the vehicle speed is above approximately 3 mph (5 km/h).



Special features

- If any one of the starting conditions is not applied, the "Apply brake + START" message is displayed on the instrument panel.

i Depending on the vehicle, you may have a digital key that offers all the functions of the card. However, if a card has been left inside the vehicle and the doors have been locked with a digital key, all of the card's functions will be inhibited. For further information, please see the "Digital key" section ➔ **60**.

i During a system update via the multimedia system it will not be possible to start the vehicle.

Wait for the update to be completed before starting the vehicle. For more information on system updates, please refer to the multimedia instructions.

i The vehicle can only be started if the charging cord is unplugged from the vehicle.

STARTING, STOPPING THE ENGINE



"Hands-free" starting with the luggage compartment open

In this case, the card should not be located in the luggage compartment, to prevent the risk of loss.

Accessories function

(switching on the ignition)

Once you have gained access to your vehicle, you may use some of its functions (radio, navigation, wipers, etc.).

To use the other functions, with the card in the passenger compartment, press the button **2** without pressing the pedals.

Operating faults

In certain cases, the "hands-free" - card may not work:

- the card battery is flat, the secondary 12 V battery is discharged, etc.;
- the card is near to appliances operating on the same frequency (monitor, mobile phone, video game device, etc.);
- the vehicle is located in a high electromagnetic radiation zone.

The "Place card on zone + START" message appears on the instrument panel.

Press the brake pedal, then place the card **4** (button side) on the placement area **3** of the upper console **A**.

Press the button **2** to start the vehicle. The message goes out.

Stopping the engine



The vehicle must be at a standstill.

Press the button **2**: the engine stops, the READY message disappears from the instrument panel and the electronic parking brake is applied.

If the card is no longer in the passenger compartment when you try to switch the engine off, the "Keycard absent : press/hold START" message appears on the instrument panel: press the button **2** for more than two seconds.

With the engine switched off, any accessories being used (radio, etc.) will continue to function for approximately 45 minutes.

STARTING, STOPPING THE ENGINE

When the driver's door is opened, the accessories stop working.



Never switch off the ignition before the vehicle has stopped completely. Once the engine has stopped, the power-assisted steering and the passive safety devices such as the Airbags and pretensioners will no longer operate.



Driver's responsibility when parking or stopping the vehicle

Never leave an animal, child or adult who is not self-sufficient alone in your vehicle, even for a short time.

They may pose a risk to themselves or to others by starting the engine, activating equipment such as the electric windows or locking the doors.

Also, in hot and/or sunny weather, please remember that the temperature inside the passenger compartment increases very quickly.

RISK OF DEATH OR SERIOUS INJURY.

GEAR CONTROL

Gear control, electronic lever

Electronic selector lever 1

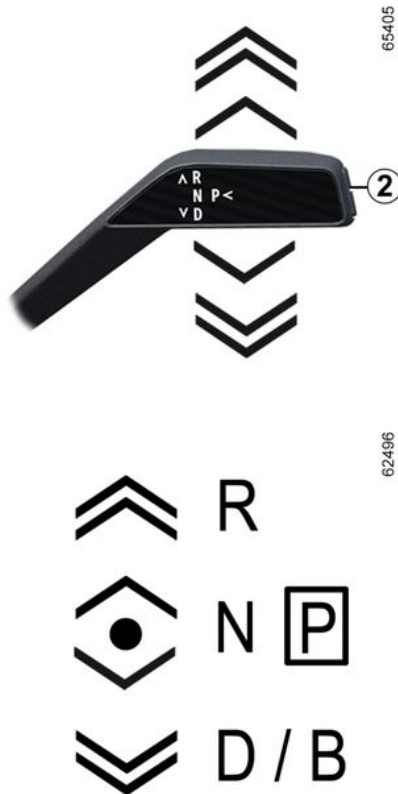

D: automatic mode

B: depending on the vehicle, regeneration mode

P: parking, button **2**

The gear engaged is displayed on the instrument panel as a reminder.

One-touch selector

Shift the selector lever **1** one or two notches upwards or downwards to the desired position (R, N, D or, depending on the vehicle, B) then release the lever and it will return to the stable position.

The position engaged is displayed on the instrument panel.

If certain conditions prevent shifting from one position to another, the current position flashes on the instrument panel.

R: reverse gear

N: neutral

GEAR CONTROL

To engage P position

65407

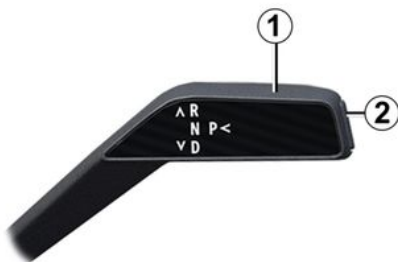

With the vehicle at a standstill and the engine or the ignition on, press the button **2** to engage the position P.



Check that the P warning light on the instrument panel is activated before leaving the vehicle.

Risk of loss of immobilisation of the vehicle

To disengage position P

With the vehicle stationary and the engine on, press the brake pedal and move the selector lever **1** upwards or downwards according to the position desired.

If the brake pedal is not pressed, the "Press brake pedal" message and the  are displayed on the instrument panel.

To engage neutral

With the vehicle stationary and the engine on, to engage position N, it is necessary to press the brake pedal before moving the selector lever **1** one notch upwards or downwards.

Driving in automatic mode

With the vehicle stationary, the engine on and your foot on the brake pedal, move the selector lever **1** two notches downwards to engage position D.

Note: if position D, R or, depending on the vehicle, if position B is engaged while the vehicle is stationary, the vehicle moves forward as soon as you release the brake pedal (without pressing on the accelerator pedal).

If one of the conditions is not met, the current position flashes for around 5

seconds and the "Press brake pedal" message is displayed on the instrument panel for approximately five seconds.

In most traffic conditions, you will not have to touch the gear lever.

Note: with the engine on and the vehicle moving between 0 and 5 mph (0 and 8 km/h), position N or R, it is necessary to press the brake pedal in order to engage position D.

Driving in mode B

(depending on the vehicle)

This mode allows driving with a more dynamic regenerative mode. When releasing the accelerator, the vehicle uses regenerative braking to slow down the vehicle. Thus the motor generates higher electrical current which allows the traction battery to be recharged.

Note: position D, R or, depending on the vehicle, if position B is engaged while the vehicle is stationary, the vehicle moves forward as soon as you release the brake pedal (without pressing on the accelerator pedal).

In B mode, the regenerative braking will be reduced if the accumulator is cold or completely charged.

GEAR CONTROL

Move from D position to B or B to D

(depending on the vehicle)

To switch from one position to the other, tilt the lever to one notch or two notches backwards.

The selected gear lever position is displayed on the instrument panel.

To select reverse gear

With the vehicle stationary and the engine on, move the selector lever **1** two notches upwards to engage position R.

Note: if position D, R or, depending on the vehicle, if position B is engaged while the vehicle is stationary, the vehicle moves forward as soon as you release the brake pedal (without pressing on the accelerator pedal).

If the brake pedal is not pressed, a beep will sound, the display of the current position flashes for around five seconds in the grid shown on the instrument panel, and the "Press brake pedal" message is displayed for around five seconds.

Note: with the engine on and the vehicle moving at between 0 and 5 mph (0 and 8 km/h), in position N, D or, depending on the vehicle, B, it is necessary to press the brake pedal to engage position R.

Parking the vehicle

Position P is engaged automatically and, if fitted, the electronic parking brake is applied when:

- the engine is stopped;
 - the driver's seatbelt is unfastened and the vehicle is stopped;
- and
- the driver's door is opened and the vehicle is stopped.

P is displayed on the instrument panel.



P position must only be engaged when the vehicle is stationary.

As position P is **automatically engaged** when the engine is stopped, it is sometimes necessary to place the vehicle in position N for some car washes, for example:

- with the engine on, press the button P, move the selector lever **1** one notch upwards or downwards to shift to N position then stop the engine;
- with the engine off and the ignition on, move the selector lever **1** one notch upwards or downwards then switch off the ignition.

The next time the engine is restarted, position P is engaged automatically according to the cases described earlier.



For safety reasons, do not switch off the ignition before the vehicle has come to a complete standstill.

Operating faults

In the event of an engine fault or an electrical fault (battery fault, etc.), make sure that the vehicle is properly immobilised.

If the "Auto gearbox P failure" message appears on the instrument panel, it may not be possible to apply the parking brake. Be sure to secure the vehicle with the electronic parking brake and consult an approved dealer.

GEAR CONTROL



An impact to the underside of the vehicle while manoeuvring (e.g. striking a post, raised kerb or other street furniture) may result in damage to the vehicle (e.g. deformation of an axle).

To avoid any risk of accident, have your vehicle checked by an approved dealer.

REGENERATIVE BRAKING SYSTEM

When releasing the accelerator pedal, the vehicle uses regenerative braking to slow down.

Some of this energy is converted to electricity to recharge the traction battery.

The paddles behind the steering wheel can be used to increase or decrease regenerative braking.



The regenerative braking should under no circumstances be used as a substitute for the brake pedal.

pedal.

Regenerative braking change paddles 1 and 2



Depending on the vehicle, paddles 1 and 2 can be used to change the regenerative braking level when the gear lever is in position D.

1: increase regenerative braking.

2: decrease regenerative braking.

The paddles can only be operated when the gear lever is in D position.

It is not possible to use the paddles while adaptive cruise control is activated → 255.

Driving with paddles



- A
- B
- C
- D
- E ONE PEDAL

Regenerative braking levels

REGENERATIVE BRAKING SYSTEM

The **3** warning light informs you of the regenerative braking level:

- **A**: "Free-wheel" level for gentle, economical driving. Requires driving with anticipation;
- **B**: low regenerative braking level;
- **C**: average regenerative braking level;
- **D**: high regenerative braking level;
- **E**: (depending on vehicle) maximum regenerative braking level and One Pedal function activated.

One Pedal function

On equipped vehicles, the One Pedal function facilitates driving in built-up areas or heavy traffic, mainly by using the accelerator pedal.

When you release the accelerator pedal sufficiently, the vehicle decelerates until it comes to a complete stop.

When you release the accelerator pedal completely, the regenerative braking level is at its maximum.

Press the accelerator pedal sufficiently to regain speed.

Activation



With the lever in **D** position, press the paddle **1** as many times as necessary

until the "One Pedal activated" message appears. The ONE PEDAL **3** warning light appears, accompanied by a beep, to confirm that it is activated.



The One Pedal function does not make an emergency stop and its braking performance is limited.



This function is an additional driving aid. This function is not under any circumstances intended to replace the due care and attention of the driver, who should at all times be in control of the vehicle.

Note: with One Pedal activated, the vehicle stationary and lever in position **D**, the vehicle will not move when you release the brake pedal.

Put on standby

When reverse gear is selected, the function goes on standby. The ONE PEDAL warning light is displayed in grey on the instrument panel.

REGENERATIVE BRAKING SYSTEM

The function reactivates in **D** position beyond a certain speed threshold. The ONE PEDAL warning light appears in blue to confirm reactivation.

Note: the parking brake is applied automatically when the vehicle remains stationary for more than approximately three minutes.

Deactivation

To deactivate the function:

- while driving, press the paddle **2**;
- when stationary, press the brake pedal and then the paddle **2**.

Thee "One Pedal deactivated" message appears on the instrument panel. The ONE PEDAL warning light **3** disappears, accompanied by a beep, to confirm deactivation.

The function deactivates automatically when the engine stops.

Limits of operation

- On low grip surfaces (frost, snow, etc.), the function may be subject to excessive deceleration in which case it is advisable to use braking levels A, B or C ➔ **174**;
- In the case of a steep slope, with the accelerator pedal released, the One Pedal function may not be sufficient to keep the vehicle stationary. Make sure the vehicle is stationary by pressing

the brake pedal, activating the electronic parking brake or, depending on the vehicle, the handbrake.

Operating faults

When the system detects a malfunction, the "One Pedal unavailable" message informs you that it is unavailable. Consult an approved dealer.

PARKING BRAKE

Electronic parking brake

Assisted operation



Applying the electronic parking brake

With the vehicle stationary, the electronic parking brake can be used to immobilise the vehicle:

– **by pressing the engine start/stop button 1** ;

or

– **when the driver's seat belt is unfastened**;

or

– **when the driver's door is opened**;



or

– **when position P is engaged**.



The electronic parking brake can be used to immobilise the vehicle. Before leaving the vehicle, check that the electronic parking brake is fully applied. Warning light 2 on switch 3 and warning

light  on the instrument panel illuminate to show that the parking brake is applied but switch off when the doors are locked. Depending on the vehicle, a sticker is located on the upper section of the windscreen to remind you of this.

In all other instances, the electronic parking brake is not applied automatically. Manual mode must be used.

For certain country-specific model versions, the assisted brake application function is not activated. See the information on "Manual operation".

To confirm that the electronic parking

brake is applied, the  warning light on the instrument panel and warning light 2 on the switch 3 light up.

PARKING BRAKE

After the engine is switched off, the indicator light **2** goes out a few minutes after the electronic parking brake has

been applied and the  warning light goes out when the vehicle is locked.

Note: in some situations (electronic parking brake failure, manual release of the parking brake, etc.), to indicate that the electronic parking brake is released a beep sounds and the "WARNING: Apply Parking Brake" message appears on the instrument panel:

- **with the engine on:** when the driver's door is opened;
- **with the engine off:** when a front door is opened.

In this case, pull and release the switch **3** to apply the electronic parking brake.

Assisted release of the parking brake

The parking brake is released:

- once the vehicle starts to accelerate;
- or
- when shifting from position P.



The electronic parking brake can be used to immobilise the vehicle. Before leaving the vehicle, check that the electronic parking brake is fully applied. Warning light **2** on switch **3** and warning

light  on the instrument panel illuminate to show that the parking brake is applied but switch off when the doors are locked. Depending on the vehicle, a sticker is located on the upper section of the windscreen to remind you of this.

Manual operation

You can apply the electronic parking brake manually.

Manually applying the electronic parking brake

Pull the switch **3**. Warning light **2** and

warning light  are illuminated on the instrument panel.

Manually releasing the electronic parking brake

Press the switch **1** without pressing the pedals to switch the ignition on.

Press the brake pedal then press the switch **3**: the warning light **2** on the

switch and the warning light  warning light disappear from the instrument panel.

Brief stop

To apply the electronic parking brake manually (when stopping at a red light, stopping when the engine is running, etc.): pull and release the switch **3**. The brake is released as soon as the vehicle is started up again.

Special cases

To park on a slope or while towing a trailer, for example, pull switch **3** for a few seconds to enable maximum braking.

To park, with the electronic parking brake released (if there is a risk of freezing, for example):

- engage position P: the drive wheels will be mechanically locked by the driveshaft;
- stop the engine by pressing the engine Start/Stop button **1**;
- unfasten the driver's seat belt;
- open the driver's door;
- manually release the electronic parking brake (please see the information

PARKING BRAKE

on "Manually releasing the electronic parking brake" on the previous page);
– depending on the vehicle, the parking brake is applied automatically. You will have to release it manually.

For safety reasons, automatic release is deactivated when the driver's door is open or not shut properly and the engine is running (in order to prevent the vehicle from moving without the driver). The "Release Parking Brake" message appears on the instrument panel when the driver presses the accelerator pedal.

Operating faults

– In the event of a fault, the warning

light  lights up on the instrument panel along with the "Check Parking Brake" message and, in some

cases, the warning light . Contact your approved Dealer straight away.

– In the event of an electronic parking

brake fault, the warning light  lights up along with the "WARNING: Braking System" message, a beep and, in some cases, the warning light



This means that you must stop as soon as traffic conditions allow.



If the "Electrical fault", "Check battery" or "WARNING: Braking System" message appears, you must immobilise the vehicle by engaging position P or by pulling the switch **3** for approximately 10 seconds.

If the conditions and the slope require it, chock the wheels of the vehicle.

Risk of loss of immobilisation of the vehicle.

Call an approved Dealer.



Never leave your vehicle without moving the selector lever to position P, applying the handbrake and switching off the engine. This is because when the vehicle is stationary with the engine running and a gear engaged, the vehicle may begin to move if you accelerate.

There is a risk of accidents.



If no lights or sounds are apparent, this indicates a fault in the instrument panel. This indicates that it is essential to stop immediately (as soon as traffic conditions allow). Ensure that the vehicle is correctly immobilised and contact an approved Dealer.

"Autohold" function

Vehicle stopped (e.g. at a red light, an intersection, a traffic jam, etc.), the function ensures braking force even when the driver releases the brake pedal.

PARKING BRAKE

The braking force is released as soon as the driver accelerates sufficiently with a gear engaged.

Activation



Press the switch **1**.

The warning light on the switch **1** comes on to confirm that the function is activated.

Deactivation

Press the switch **1**. If your vehicle is maintained by braking force you can also press the brake pedal.

The warning light on the switch **1** disappears to confirm that the function is deactivated.

If the braking force is maintained, the parking brake is applied automatically when:

- the driver opens the door;
- or
- the driver unfastens their seat belt;
- or
- the vehicle is immobilised for more than approximately three minutes.

 Upon each start-up, the function continues the mode set at the time the engine was last switched off.



The electronic parking brake can be used to immobilise the vehicle. Before leaving the vehicle, check that the electronic parking brake is fully applied. When the parking brake is applied, this is confirmed by the illumination of the warning light on the switch **2**

and the warning light  displayed on the instrument panel until the doors have been locked. Depending on the vehicle, a sticker is located on the upper section of the windscreen to remind you of this.

Conditions for maintaining the braking force

The following conditions must be met:

- the driver's door is closed;
- and
- the driver's seat belt is fastened;
- and
- the electronic parking brake is released;
- and

PARKING BRAKE

– the vehicle is not stationary on a very steep slope.

The maintained braking force is confirmed by the warning light  on the instrument panel.

Conditions for interrupting the braking force

The following conditions must be met:

– the driver accelerates sufficiently with a gear engaged;

or

– the driver disables the function.

The warning light  disappears from the instrument panel.

ENVIRONMENT

Manufacture

Your vehicle has been designed with respect for the **environment** in mind for its entire service life: during its production, usage and at the end of its service life.

Your vehicle has been manufactured at a factory which complies with a policy to reduce the environmental impact on the surrounding areas (reduction of water and energy consumption, visual and noise pollution, atmospheric emissions and waste water; sorting and reusing waste).

Please make your own contribution towards protecting the environment too.

– Parts and vehicles at the end of their life must not be thrown away. They must be handed to a legal entity that complies with environmental standards.



61496

Recycling

Your vehicle is at least 85% recyclable and at least 95% recoverable.

To achieve these objectives, many of the vehicle components have been designed to enable them to be recycled.

The materials and structures have been carefully designed to:

- allow these components to be easily removed and reprocessed by specialist companies;
- promote a circular economy (re-use, recycling, recovery, etc.)

This is particularly true for electrified vehicle batteries.

In order to preserve raw material resources, your vehicle also includes many parts made from recycled plastics or renewable materials.

- Worn parts and components that are replaced during routine vehicle maintenance, such as tyres, must be disposed of at dedicated collection points.
- Worn **electrical** and **electronic** components that are replaced (such as batteries, etc.) must not be thrown away as rubbish. Take them to an approved Dealer or consult your local authority for information on appropriate recycling facilities.
- To optimise the recycling of your vehicle at the end of its life, you can contact an authorised dealer or visit the manufacturer's website to be directed to collection points that guarantee respect for the environment complying with local laws.

DRIVING ADVICE, ECO-DRIVING

Eco-driving

Driving advice, eco-driving

Range is accredited in according to a standard regulatory method. Identical for all manufacturers, this enables vehicles to be compared with one another.

Range in real time depends on vehicle usage conditions, equipment fitted and the user's driving style. To optimise range, please refer to the following advice.

Depending on the versions, you will be provided with functions which enable you to lower energy consumption:

- on the instrument panel:
 - the power meter;
 - the driving style indicator;
- on the multimedia screen:
 - data relating to your energy consumption;
 - an energy consumption graph;
 - scores based on your driving style;
 - Eco driving advice;
 - a route planner;
 - an ECO driving mode.

Power meter

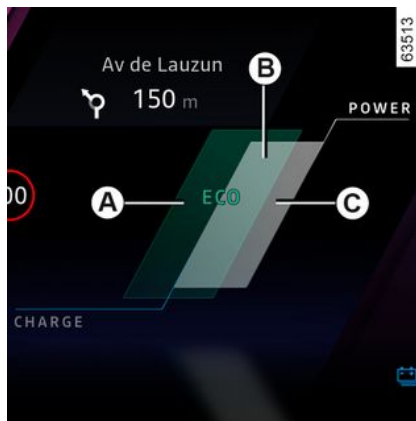

(on the instrument panel)

The charge meter gives you a real-time view of the energy consumed or recovered when the vehicle is moving.

"Energy recovery" A usage zone

When driving, if you lift your foot off the accelerator pedal or press the brake pedal, the motor generates electrical current during deceleration, and this energy is used to slow down the vehicle and recharge the traction battery → 174.

"Optimal" B usage zone

Indicates economical driving, balanced between recovery and energy expenditure.

"Energy consumption" C usage area

The traction battery supplies the electrical energy required for the motor to move the vehicle.



The presence and display of this information depends on the ambient setting selected → 133.

Driving style indicator

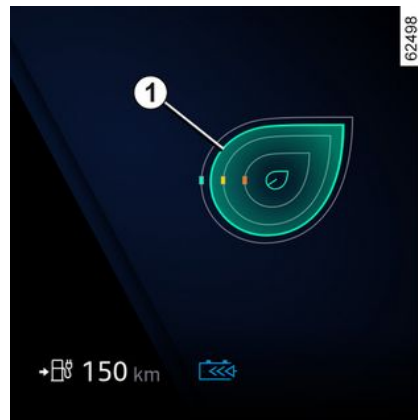

Informs you about the driving style adopted in real time. This is indicated by the warning light 1.

DRIVING ADVICE, ECO-DRIVING

You can display the driving style indicator by repeatedly pressing upwards/downwards on the switch **2**.



The larger the leaf displayed on the indicator **1** is, the better the management of speed, acceleration and anticipation in terms of eco-driving.

The smaller the leaf displayed on the indicator **1** is, the worse the management of speed, acceleration and anticipation in terms of eco-driving.

In the case of behaviour that is deemed unecological (small orange leaf), advice relating to your driving habits may be sent to you.

If you regularly follow this indicator, you will increase your vehicle's electrical range.

ECO mode

ECO mode is a function that optimises vehicle range. It acts on some of the vehicle's energy-consuming systems (air conditioning, etc.) and on the vehicle's behaviour (acceleration, cruise control, deceleration, etc.)

Activation/deactivation from the multimedia screen **3**

To activate or deactivate the function, refer to the multimedia instructions.



While driving, it is possible to exit the ECO mode temporarily in order to improve engine performance.

To do this, press the accelerator pedal firmly and fully. ECO mode is reactivat-

ed when you take pressure off the accelerator pedal.

 With ECO mode activated, the vehicle speed is limited to approximately 71 mph (115 km/h).

Journey record

On equipped vehicles, once the engine is switched off, a "Journey log" is displayed on the multimedia screen **3**. This log shows the information relating to your last journey:

- your average energy consumption;
- the number of miles/kilometres travelled;
- an overall grade taking into account acceleration, braking anticipation and your skill in managing speed;
- advice to enable you to improve your rating.

Please refer to the multimedia instructions for further information.

Navigation system

Using the information available on your navigation system (traffic information, nearest charging station, etc.) makes it easy to manage your journey.

DRIVING ADVICE, ECO-DRIVING

Vehicle range

Advice

In real usage, the range of an electric vehicle may vary depending on several factors over which you have partial control, which may make a considerable difference to the vehicle range.

These factors are:

- speed and driving style;
- road type;
- heating level;
- tyres;
- use of electrical accessories;
- vehicle loading.

Furthermore, activating mode ECO enables the vehicle to automatically take charge of all energy consumers (engine power etc.) to reduce their consumption to the fullest possible extent → 183.

Speed and driving style



62427

Driving at high speed will significantly reduce your vehicle's range.

Examples (at a steady speed):

- reducing the speed from approximately 80 mph (130 km/h) to 68 mph (110 km/h) allows you to save up to around 20% of fuel range;
- reducing your speed from approximately 56 mph (90 km/h) to 50 mph (80 km/h) allows you to save up to around 10% of fuel range.

"Sporty" driving reduces your vehicle's range: opt for a "smoother" driving style.

Advice:

- drive at a constant speed;

- keep an eye on the tools available to you to view the road conditions (charge meter, current consumption, journey record, etc.) → 183;
- adapt your driving style to avoid excessive energy consumption;
- favour energy recovery: anticipate traffic changes by taking your foot off the accelerator pedal or braking gradually.

Road type



62428

Do not try to maintain the same speed up a hill; accelerate no more than you would on the level. Keep your foot in the same position on the accelerator pedal.

DRIVING ADVICE, ECO-DRIVING

Heating levels

62429

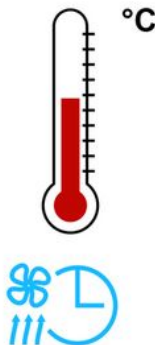

The use of heating or air-conditioning reduces vehicle range.

To maintain your vehicle range, we recommend that you select the "programming" mode before using the vehicle → **313**.

Vehicle loading

Avoid pointlessly overloading your vehicle.

Tyres

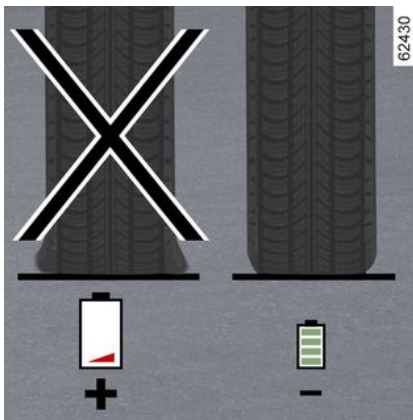

An under-inflated tyre increases energy consumption. Comply with the specified tyre pressures for your vehicle.

When driving, use tyres made by the same manufacturer, with the same dimensions, type and structure as the original tyres. The use of non-regulation tyres significantly reduces vehicle range → **344**.

TYRE PRESSURE LOSS WARNING

61319

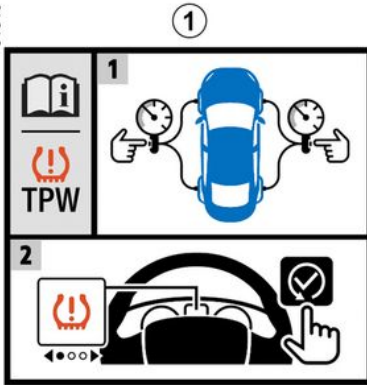

68404



When fitted to the vehicle, this system notifies the driver if one or more tyres lose pressure.

The system can be identified by the 1 label in the vehicle.

Operating principle



This system detects a loss of pressure in one of the tyres by measuring the wheel speed while driving.

Warning light  2 comes on steady to alert the driver in the event of insufficient pressure (deflated wheel, punctured tyre, etc.).



This function is an additional driving aid.

The function does not take the place of the driver. It cannot, therefore, under any circumstances replace the vigilance or the responsibility of the driver. Check the tyre pressures, including the emergency spare wheel, once a month.

Operating conditions

In order to provide a reliable warning in the event of significant pressure loss, the system must be reset with an inflation pressure equal to one of those shown on the tyre inflation pressure label (reference values) → 346.

Resetting should always be carried out after checking the tyre pressure of all four tyres when cold.

In the following situations, the system risk coming into action late or not functioning correctly:

- system not reset after reinflation or any operation on the wheels;
- incorrectly reset system: tyre pressures different from the recommended pressures;

TYRE PRESSURE LOSS WARNING

- significant change in load or distribution of load on one side of the vehicle;
- sporty driving with strong acceleration;
- driving on snowy or slippery surface;
- driving with snow chains;
- fitting a single new tyre;
- use of tyres not approved by the network.



Tyre pressure must be checked before starting the resetting procedure.

The system will not issue a warning if the pressure does not correspond to the recommended pressure.



A sudden loss of pressure in a tyre (burst tyre, etc.) may not be immediately detected by the system.

Procedure for resetting the standard levels for the tyre pressures

This should be performed:

- after each re-inflation or resetting of tyre pressure;

- after changing a wheel;
- after swapping a wheel (however, this practice is not recommended).

Tyre pressures must correspond to the current usage of the vehicle (empty, carrying a load, motorway driving, etc.). Respect the tyre pressures (including the emergency spare wheel). Check them at least once a month and before a long journey (refer to the label on the edge of the driver's door → 344).

Resetting procedure via the multimedia screen 3



The resetting procedure must be carried out while the vehicle is stationary and the ignition is switched on.

Please refer to the multimedia instructions for further information.

TYRE PRESSURE LOSS WARNING

Message display

The table below shows the possible messages related to the tyre resetting procedure.

Steps	Messages	Readings
-	Tyre pressure init. at stop	The message is displayed during driving. If you want to reset the pressure of the four tyres, stop the vehicle.
1	Tyre pressure init. long press	To reset the pressure of the four tyres, with the vehicle stopped, press and hold the 5 OK switch to launch resetting until the "If pressure OK [hold on]" message is displayed.
2	If pressure OK [hold on]	The message flashes as a reminder that the pressure must be adjusted to the reference values recommended on the tyre inflation pressure label ➔ 346 . To confirm the reset request, press and hold switch 5 OK until the "Operation completed" message appears.
3	Operation completed	The resetting procedure has been completed successfully. You can now drive.

TYRE PRESSURE LOSS WARNING

Readjustment of tyre pressures

The pressure of the four tyres must be set when cold (refer to the label located on the edge of the driver's door) → 346.

If tyre pressures cannot be checked when the tyres are cold, **the recommended pressures should be increased by 0.2 to 0.3 bar (3 PSI).**

Never deflate a hot tyre.

After each reinflation or readjustment of the tyre pressure, launch the resetting of the tyre pressure reference value.

Replacing wheels/tyres

Only use equipment approved by the brand network, otherwise the system risks late activation or incorrect operation → 344.

After each change of wheel/tyre, readjust the tyre pressure and launch the reset of the tyre pressure reference value.

Emergency spare wheel

If fitted on the vehicle, readjust the tyre pressure and launch the resetting of the tyre pressure reference value.

Tyre repair product and inflation kit

Only use equipment approved by the brand network, otherwise there is risk of the system being activated late or not working correctly → 347. After using the tyre inflation kit, readjust the tyre pressure and launch the resetting of the tyre pressure reference value.

Tyre pressure faults







The table lists the warning messages which appear on the instrument panel **6** when the system detects a tyre pressure fault.

The information on the instrument panel signals any potential tyre

pressure faults (e.g. deflated or punctured tyre).

TYRE PRESSURE LOSS WARNING

Fault message table

Indicator lights	Messages	Readings
 comes on	Inflate tyres and init.	This indicates that tyre under-inflation or puncture has been detected. Check and adjust the pressure of the four tyres when cold and reset the system.
 flashes, then stays on	Check tyre press and init.	This indicates that the reset has been unsuccessful. Check and readjust the tyre pressure before re-launching the resetting procedure.
 flashes, then stays on, along with the warning light 	Check TPW	This indicates a fault in the system. Consult an approved dealer.
 flashes, then stays on	TPW not available	This indicates that an emergency spare wheel different in size to the other four wheels has been fitted to the vehicle. The system remains unavailable until a wheel identical in size to the other wheels has been fitted and the resetting procedure has been carried out.

DRIVER CORRECTION DEVICES AND AIDS

Depending on the vehicle, they comprise:

- of the **ABS (anti-lock braking system)**;
- of the **electronic stability programESC with understeer control and traction control**;
- **emergency braking assistance with (depending on the vehicle) braking anticipation**;
- **hill start assistance**;
- **multi-collision braking**;
- **regenerative braking system**.

Other driving assistance systems are described in this leaflet.



These functions are an additional aid in the event of critical driving conditions, enabling the vehicle behaviour to be adapted to suit the driving conditions. However, the functions do not take the place of the driver. **They do not increase the vehicle's limits and should not encourage you to drive more quickly.** Therefore, they can under no circumstances replace the vigilance or responsibility of the driver when manoeuvring the vehicle (the driver must always be ready for sudden incidents which may occur when driving).

ABS (anti-lock braking system)

Under heavy braking, the ABS prevents the wheels from locking, allowing the stopping distance to be managed and keeping control of the vehicle.

Under these circumstances, the vehicle can be steered to avoid an obstacle whilst braking. In addition, this system can increase stopping distances, particularly on roads with low surface grip (wet ground etc.).



You will feel a pulsation through the brake pedal each time the system is activated. The ABS does not in any way improve the vehicle's "physical" performance relating to the road surface and roadholding. It is still **essential** to follow the rules of good driving practice (such as driving at a safe distance from the vehicle in front etc.).



In an emergency, apply **firm and continuous pressure** to the brake pedal.

There is no need to pump it repeatedly. The ABS will modulate the force applied in the braking system.

Operating faults

–  and  lit on the instrument panel accompanied, depending on the vehicle, by the messages "Check ABS", "WARNING: Check Braking System" and "Check ESC": the ABS, the ESC and the emergency brake assist are deactivated. **Braking is still provided**;

– , ,  and

 illuminated on the instrument

DRIVER CORRECTION DEVICES AND AIDS

panel accompanied by the "WARNING: Braking System" message: **this indicates a fault with the braking system.**

In both cases, please consult an Authorised Dealer.



Your braking systems are partially operational. However, **it is dangerous to brake suddenly** and it is essential to stop immediately, as soon as traffic conditions allow. Call an approved Dealer.

Electronic stability control ESC with understeer control and traction control

Electronic stability control ESC

This system helps you to keep control of the vehicle in critical driving conditions (avoiding an obstacle, loss of grip on a bend, etc.).

Operating principle

A sensor in the steering wheel detects the direction selected by the driver.

Other sensors throughout the vehicle measure the actual direction.

The system compares driver input to the actual trajectory of the vehicle and

corrects the trajectory if necessary by controlling the braking of certain wheels and/or engine power. In the event that the system is triggered, the

warning light  flashes on the instrument panel.

Understeer control

This system optimises the action of the ESC in the case of pronounced understeering (loss of front axle road holding).

Traction control

This system helps to limit wheelspin of the drive wheels and to control the vehicle when pulling away accelerating or decelerating.

Operating principle

Using the wheel sensors, the system measures and compares the speed of the drive wheels at all times and slows down their over-rotation. If a wheel is starting to slip, the system brakes automatically until the drive supplied becomes compatible with the level of grip under the wheel again.

Operating faults

When the system detects an operating fault, the "Check ESC" message and

the  and  are displayed on the instrument panel. In this case,

the ESC and traction control system are deactivated.

Consult an approved dealer.

Emergency brake assist

This system supplements the ABS and helps reduce vehicle stopping distances.

Operating principle

The system is for detecting an emergency braking situation. In this case, the braking system immediately develops maximum power and may trigger ABS regulation.

ABS braking is maintained as long as the brake pedal is applied.

Brake lights come on

Depending on the vehicle, these may flash in the event of sudden deceleration.

Braking anticipation

Depending on the vehicle, when you rapidly release the accelerator, the system anticipates the braking manoeuvre in order to reduce stopping distances.

Special cases

When using the cruise control:

– if you use the accelerator pedal when you release it, the system may be triggered;

DRIVER CORRECTION DEVICES AND AIDS

– if you do not use the accelerator, the system will not be triggered.

Operating faults

When the system detects an operating fault, the "WARNING: Check Braking System" message appears on the instrument panel along with the



Consult an approved dealer.



These functions are an additional aid in the event of critical driving conditions, enabling the vehicle behaviour to be adapted to suit the driving conditions. These functions do not take the place of the driver. **They do not increase the vehicle's limits and should not encourage you to drive more quickly.** Therefore, they can under no circumstances replace the vigilance or responsibility of the driver when manoeuvring the vehicle (the driver must always be ready for sudden incidents which may occur when driving).

Hill start assistance

Depending on the gradient of the incline, this system assists the driver when starting on a hill. It prevents the vehicle from rolling backwards by automatically applying the brakes when the driver lifts his/her foot off the brake pedal to depress the accelerator pedal.

System operation

It only operates when the gear lever is in a position other than N and the vehicle is completely stationary (brake pedal depressed).

The system holds the vehicle for approximately **2 seconds**. The brakes are then gradually released (the vehicle will move according to the slope).



The hill start assistance system cannot completely prevent the vehicle from rolling backwards in all situations (extremely steep gradients etc.).

In all cases, the driver may depress the brake pedal to prevent the vehicle from rolling backwards.

The Hill Start Assist function should not be used for prolonged stops: use the brake pedal.

This function is not designed to immobilise the vehicle permanently.

If necessary, use the brake pedal to stop the vehicle.

The driver must remain particularly vigilant when driving on slippery or low-grip surfaces.

Risk of serious injury.

Multi-collision braking

Multi-collision braking reduces the risk of an additional collision after an accident by temporarily bringing your vehicle to a standstill.

DRIVER CORRECTION DEVICES AND AIDS

Operating principle

When the airbag system detects a collision, the pretensioners or airbags are triggered → 88 and the "Multi-collision braking" function activates the Electronic Stability Program (ESC) to brake the vehicle.

Multi-collision braking is deactivated during operation if:

- the driver presses the accelerator pedal firmly;

and/or

- the braking force generated by the driver pressing the brake pedal is greater than the force produced by the automatic braking triggered by the function.

Note: multi-collision braking requires the proper functioning of your vehicle's braking system.

Operating faults

When the system detects an operating fault, the message "Check Post-collision" and the warning light  appears on the instrument panel.

In this case, the function is deactivated. Consult an approved Dealer.

Regenerative braking system

When braking, the regenerative braking system can convert the energy produced by the vehicle deceleration into electric energy.

This will recharge the 400 V traction battery and provide greater vehicle range.

Operating faults

-  lit on the instrument panel accompanied by the message "WARNING: Check Braking System": **braking assistance is still operational.**

Under these conditions, the feel of applying the brake pedal may be different.

You are recommended to apply strong continuous pressure to the pedal.

Please see an authorised dealer.

-  lit on the instrument panel accompanied by the message "WARNING: Braking System": **this indicates a fault with the braking system.**

Please call an authorised dealer.



The warning light

 for your own safety, it requires you to stop immediately as soon as traffic conditions allow. Switch off the engine and do not restart it. Call an approved Dealer.

ADDITIONAL DRIVING AID FUNCTIONS

My Safety

The "My Safety" function can be used to deactivate or activate a set of driver assistance functions simultaneously.

Depending on the vehicle, you can configure the "My Safety" function from the multimedia screen by selecting the driving aid functions to be switched off as a group.

Operation



"ALL ON" mode

Depending on the vehicle, the functions and configurations of driving assistance concerned are:

- overspeed sound alert → 229;
- lane departure prevention → 197;
- driver vigilance warning → 227;
- emergency lane departure prevention → 204.

When the "All on" mode is activated: the "My Safety All ON selected" message is displayed on the instrument panel to confirm this. The driving aids that are available in the mode are activated.

"Perso" mode

You can use this mode to **deactivate** or **reactivate** certain driving aids that are available in the "All on" mode previously configured using the "MY SAFETY PERSO" setting.

With the ignition on, **press** button **1** twice in succession to activate "Perso" mode. On the first press, the "Press again for My Safety Custom" message is displayed on the instrument panel. On the second press, the indicator light on the button **1** goes out. "Perso" mode is activated. The "My Safety Perso selected" message is displayed on the instrument panel.

To switch back to "ALL ON" mode, **press** button **1** once. The indicator light on button **1** lights up.



Depending on the vehicle and on the length of time since the last time the engine was stopped, the "ALL ON" mode is reactivated:

- when the vehicle is unlocked;
- or
- when a door is opened;
- or
- when the engine is restarted.

Perso mode configuration



For safety reasons, carry out any adjustments while the vehicle is stationary.



The "MY SAFETY PERSO" settings saved for the "Custom" mode are stored when the engine was last stopped or when the doors were locked.

ADDITIONAL DRIVING AID FUNCTIONS

From the multimedia screen 2



Please refer to the multimedia instructions for more information.

Lane departure prevention

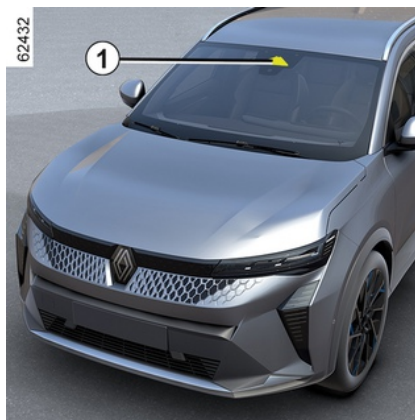

Using information from the **1** camera, the function triggers corrective action on the vehicle steering system when a continuous or broken line is crossed or when approaching the roadside (divider, barrier, pavement, embankment, etc.) without activating the direction indicator lights.

Depending on the setting, in the event of crossing a broken line without activating the direction indicator lights, the function:

- warns the driver without corrective action on the steering system;
- or

- performs corrective action on the steering system.

 You can **retake control of the vehicle** at any time by operating the steering wheel.

Location of the camera 1

Make sure the windscreen is not obscured (by dirt, mud, snow, condensation etc.).



This function is an additional driving aid. This function is not under any circumstances intended to replace the due care and attention of the driver, who should at all times be in control of the vehicle.

ADDITIONAL DRIVING AID FUNCTIONS

Activation/deactivation

From the multimedia screen 2



Please refer to the multimedia instructions for more information.

Using the switch 3



– **To deactivate the function**, if it has been deactivated from the "custom" mode of the "My Safety" → 196func-

tion, press switch 3 twice. The warning light is displayed in yellow on the instrument panel.

– **To reactivate the function**, press the 3 switch once. Warning light  comes on the instrument panel.

Operation



When the function is activated, the



and the left-hand and right-hand line indicators 5 are displayed in grey on the instrument panel.

The function is set to alert or intervene when the vehicle speed is between approximately 40 mph (65 km/h) and 112 mph (180 km/h) and if the



warning light and the left-hand and right-hand line indicators 5 appear in white.

The function is in operation if the vehicle

– approaches a roadside without activating direction indicators;

ADDITIONAL DRIVING AID FUNCTIONS

- crosses a continuous line without activating the indicator lights;
- crosses a broken line without activating the direction indicators, if the "operation on broken line" setting is selected.

In these cases:

- the function triggers an action on the vehicle's steering system to correct the vehicle trajectory;

- the  warning light and the indicator **5** on the side of the breached line changes to yellow on the instrument panel.

If the corrective action on the steering

system is not sufficient, the  warning light and the indicator **5** on the side of the breached line change to red on the instrument panel, accompanied by a vibration on the steering wheel.

When the "Operation on broken line" setting is not selected, **the function sounds the alarm** if the vehicle crosses a broken line without activating the indicator lights, and there is no road-side close enough to the line.

In this case, the function warns the driver:

- by a vibration in the steering wheel; and

- the  warning light and the indicator **5** on the side of the breached line turns to red on the instrument panel.

Note: on bends, the function allows for slightly cutting the bend.

Special cases

"Keep control" Warning

- If the system is operating and does not detect any activity on the steering wheel, the "Keep control" message appears on the instrument panel accompanied by a beep and, depending on

the vehicle, the  warning light appears in yellow until the driver has regained control of the vehicle.

- If the system has been in operation for too long, the "Keep control" message appears on the instrument panel accompanied by a beep and depend-

ing on the vehicle, the  warning light appears in yellow accompanied by the indicator **4** on the side of the line concerned until the driver has regained control of the vehicle.



You can interrupt the trajectory correction at any time by moving the steering wheel.

Vehicle fitted with "Active driver assist"

If the "Lane centring" function is activated at the same time as the "Lane departure prevention" function, the display of the warning light will vary as follows:

- the "Lane Centring" function is in operation: the green  warning light

replaces the white or grey  warning light on the instrument panel. Thus, you are informed as a priority of the status of the function "Channel centring";

- the "Lane Centring" function is put on standby and the "Lane Departure Prevention" function is neither ready

nor in operation: the grey  warning light replaces the white or grey

 warning light on the instrument panel. Thus, you are informed as a priority of the status of the function "Channel centring";

ADDITIONAL DRIVING AID FUNCTIONS

– the "Lane Centring" function is put on standby while the "Lane Departure Prevention" function is ready or in operation:

the  warning light is displayed in red or in yellow on the instrument panel. Thus, you are informed as a priority of the status of the function "Lane departure prevention".

In any case, you are informed at all times of the status of the function when it controls the steering system of your vehicle. The most useful information is always displayed.

Temporary unavailability / function disabled

The system is temporarily unavailable or disabled when:

- very fast lane departure;
- driving continuously on a line;
- approximately four seconds after changing lanes;
- tight bends;
- impaired visibility;
- one of the direction indicators is activated;
- activating the hazard warning lights;
- engaging reverse gear;
- strong acceleration;
- the lane width changes;
- operation of the Electronic Stability Control system;

- operation of the anti-lock braking system;
- the active emergency braking system is triggered;
- intervention of another function that controls the steering system, such as the "Lane Centring" function.

When the function is unavailable, the warning light  and left/right line correction indicators **5** turn to grey on the instrument panel.

If the front camera is obscured, the "Front camera without visibility" message is displayed on the instrument panel. Clean the area where the sensors are located

Automatic deactivation

The function is automatically deactivated when:

- The vehicle dynamics control system is deactivated;
- The electronic stability system is malfunctioning;
- The anti-lock braking system is malfunctioning;
- a towbar is electrically connected to the trailer hitch socket;
- warning light  is displayed.

When the function is deactivated, the warning light  is displayed in yellow on the instrument panel.

Settings



ADDITIONAL DRIVING AID FUNCTIONS

Using the switch 3



To access the multimedia screen function settings **2**, refer to the multimedia instructions:

– "Operation on broken line": use this setting to select the response of the function if the vehicle crosses a broken line without activating the direction indicators:

- selected setting: the function may trigger an action on the vehicle's steering system to correct the vehicle trajectory;
- setting not selected: the function can warn the driver by means of a vibration at the steering wheel without correcting the vehicle trajectory.

– "Vibration": adjust the steering wheel vibration for the "Lane departure prevention" function;

– "Lane exit anticipation": adjust the line detection sensitivity level. To do this, select:

- "Late": line detected upon crossing;
- "Standard": line detected on approach;
- "Early" line detected nearby.

Please refer to the multimedia instructions for further information.

Operating faults

When the system detects an operating fault, the left-hand and right-hand line

indicators and the warning light  are displayed in yellow on the instrument panel.

In some cases, they are accompanied by the following message:

- «Driving assist unavailable» ;
- or
- «Check Front camera» ;
- or
- «Check Driving assist».

Consult an approved dealer.

ADDITIONAL DRIVING AID FUNCTIONS

Warnings



This function is an additional driving aid. This function is not under any circumstances intended to replace the due care and attention of the driver, who should at all times be in control of the vehicle.

System servicing/repairs

- In the event of an impact, the camera alignment may be changed, and its operation may consequently be affected. Deactivate the function and consult an authorised dealer.
- Any work in the area where the camera is located (repairs, replacements, windscreen modifications etc.) must be carried out by a qualified professional.

Only an authorised dealer is qualified to service the system.

In the event of system disturbance

Some conditions can disturb or damage the system's operation, such as:

- windscreen obscured (by dirt, ice, snow, condensation etc.);
- a complex environment (tunnel, etc.);
- poor weather conditions (snow, rain, hail, black ice, etc.);
- poor visibility (night, fog, etc.);
- the road markings are irregular or difficult to distinguish (e.g. partially erased, excessive spacing, uneven road surface, etc.);
- being dazzled (glaring sun, lights of vehicles travelling in the opposite direction; etc.);
- the road is narrow, winding or undulating (tight bends, etc.);
- closely following a vehicle travelling in the same lane.

In this case, the function "Lane departure prevention" may trigger incorrectly or not at all.

Risk of unwanted, incorrect correction or no correction of trajectory.

Deactivating the function

You must deactivate the function if:

- the area of the camera has been damaged (on the windscreen side or the interior rear-view mirror side);
- the road is slippery (snow, black ice, aquaplaning, gravel etc.);
- poor visibility (night, fog, etc.);

ADDITIONAL DRIVING AID FUNCTIONS

- the windscreen is cracked or distorted (do not carry out windscreen repairs in this area; have it changed by an approved dealer);
- the vehicle is towing a trailer or a caravan;
- the vehicle is entering an area with several surface markings (an area with road works etc.).

ADDITIONAL DRIVING AID FUNCTIONS

Emergency lane departure prevention

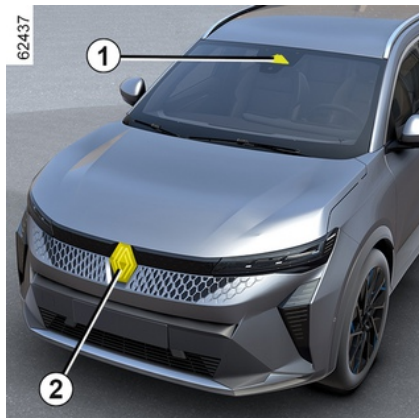

Using information from the radar **2** and the camera **1**, the function triggers corrective action on the vehicle steering system in the event of a risk of collision with a vehicle coming from the opposite direction in the adjacent lane, without the direction indicator having been activated.

Depending on the vehicle, using information from the radars **3** and the camera **1**, the function triggers corrective action on the vehicle steering system in the event of a risk of collision with a vehicle moving at the same speed or at a higher speed, if within the detection area of the rear radars.

 You can **retake control of the vehicle** at any time by operating the steering wheel.



This system provides an additional driving aid. This system is not, under any circumstances, intended to replace the due care and attention of the driver, who should at all times be in control of the vehicle.

Location of the camera **1**

Make sure the windscreen is not obscured (by dirt, mud, snow, condensation etc.).

Location of the front radar **2**

Ensure that the radar area is not obstructed (dirt, mud, snow, a badly fitted/attached front number plate), impacted, modified (including paintwork) or hidden by any accessory fitted on the front of the vehicle (on the front bumper, logo, etc.)

Location of the side radars **3**

Ensure that the radar area is not obstructed (by dirt, mud, snow etc.), impacted or modified (including paintwork etc.).

ADDITIONAL DRIVING AID FUNCTIONS

Activating/deactivating the function

From the **A** "My Safety" switch



Press **A** switch twice if the function has been disabled from the Personal mode of the "My Safety" → 196function.

To reactivate the function, press the **A** switch.

From the **B** multimedia screen



Please refer to the multimedia instructions for more information.

Detection of an oncoming vehicle

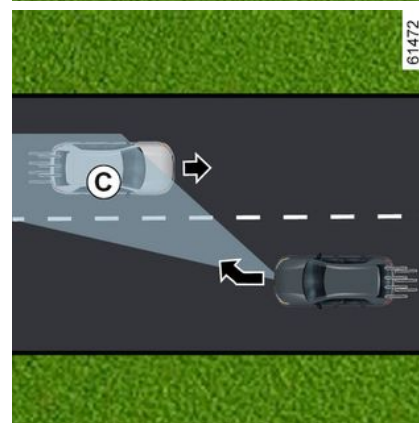
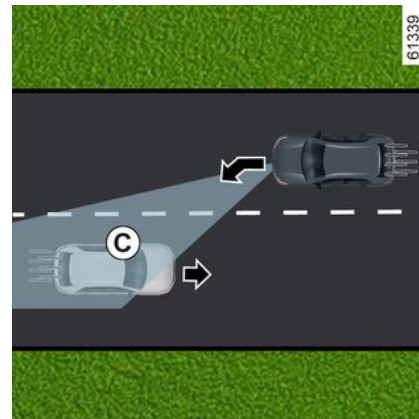

3

ADDITIONAL DRIVING AID FUNCTIONS

3



lision with a vehicle coming from the opposite direction in an adjacent lane and within the detection zone **C**, without the direction indicator having been activated, the system:

- **warns you of a collision risk:**

The message "Risk of collision" is displayed on the dashboard accompanied by the indicator **4** in red, the line on the side of the intervention and an audible signal. Display **5** appears on the instrument panel on the side of the intervention;

and

- **triggers corrective action on the steering system.**



You can interrupt the trajectory correction at any time by moving the steering wheel.



This function is an additional driving aid.

This function is not under any circumstances intended to replace the due care and attention of the driver, who should at all times be in control of the vehicle.

The function may not activate if the approaching speed is greater than approximately 124 mph (200 km/h) (for example, you are travelling at 68 mph (110 km/h) and the vehicle is travelling in the opposite direction in the adjacent lane at 56 mph (91 km/h)).

When driving at a speed between approximately 40 mph (65 km/h) and 68 mph (110 km/h), if there is a risk of col-

ADDITIONAL DRIVING AID FUNCTIONS

If case of overtaking

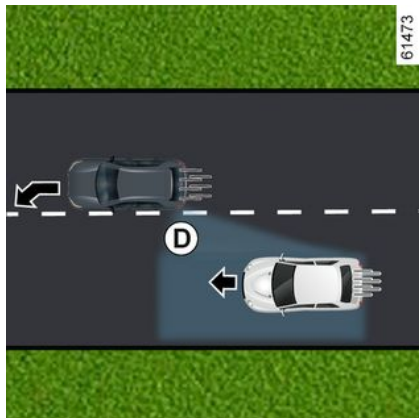
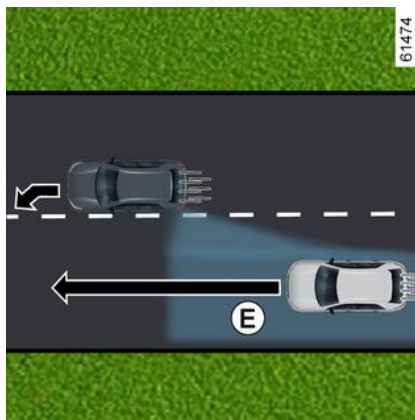

3

While driving at a speed between approximately 40 mph (65 km/h) and 112 mph (180 km/h), when approaching a line (continuous or broken) and there is a risk of collision with a vehicle located in the blind spot **D** and it is moving in the same direction as your vehicle or with a vehicle that is rapidly approaching from behind in an adjacent lane that is in the detection area **E**, the system:

– **warns you about a risk of collision:** the warning light **7** flashes, the message "Lateral obstacle detected" is displayed on the instrument panel, accompanied by the indicator **4** in red, the line on the side of the intervention and an audible signal. Display **5** ap-

ADDITIONAL DRIVING AID FUNCTIONS

appears on the instrument panel on the side of the intervention;
and

- **triggers corrective action on the steering system.**

Temporarily not available / non-activation of the system

The system is temporarily unavailable or disabled when:

- very fast lane departure;
- driving continuously on a line;
- approximately four seconds after changing lanes;
- tight bends;
- impaired visibility;
- activation of the direction indicator light (only when an oncoming vehicle is detected in an adjacent lane);
- activating the hazard warning lights;
- strong acceleration;
- the lane width changes;
- operation of the Electronic Stability Control system;
- operation of the anti-lock braking system;
- operation of the active emergency braking system;
- ...

The system cannot be activated when:

- the camera does not detect a line (solid or broken) on the relevant side;

- the camera does not simultaneously detect the two boundaries of the lane in which your vehicle is moving;
- reverse gear is engaged;
- the field of vision of the camera is obstructed;
- the front radar is obscured;
- depending on the vehicle, the rear radars are obscured;
- ...

Depending on the vehicle, if one of the side radars is obscured the message "Side radars no visibility" will appear on the instrument panel.

When the front radar is obscured, the "Front radar no visibility" message is displayed on the instrument panel.

When the front camera is obscured, the "Front camera no visibility" message is displayed on the instrument panel.

Clean the area where the sensors are located.

Automatically deactivating the function

The system is automatically deactivated when:

- The vehicle dynamics control system is deactivated;
- The electronic stability system is malfunctioning;

- The anti-lock braking system is malfunctioning;
- A towbar is electrically connected to the trailer hitch socket;
- the **STOP** warning light is displayed.

If the vehicle is equipped with a towbar that is recognised by the system, the message "Trailer: side radars unavailable" is displayed to inform you that the emergency lane departure prevention function has been deactivated.

If the vehicle is towing a trailer or caravan, unexpected or unnecessary corrections may occur. You can deactivate the system to avoid unexpected or unnecessary corrections.

Operating faults

When the function detects an operating fault, the following messages may be displayed on the instrument panel:

- « Check Front camera » ;
 - or
 - « Front radar to check » ;
 - or
 - « Check Driving assist » ;
 - or, depending on the vehicle,
 - « Check Side radars » .
- Consult an approved dealer.

ADDITIONAL DRIVING AID FUNCTIONS

Warnings



This function is an additional driving aid. This function is not under any circumstances intended to replace the due care and attention of the driver, who should at all times be in control of the vehicle.

System servicing/repairs

- In the event of an impact, the alignment of the camera or radar(s) may be altered and its operation may consequently be affected. Deactivate the function and consult an authorised dealer.
- Any work in the area where the camera or radars are located (replacements, repairs, windscreen modifications etc.) must be carried out by a qualified professional.

Only an authorised dealer is qualified to service the system.

In the event of system disturbance

Some conditions can disturb or damage the system's operation, such as:

- windscreen obscured (by dirt, ice, snow, condensation etc.);
- a complex environment (tunnel, etc.);
- poor weather conditions (snow, rain, hail, black ice, etc.);
- poor visibility (night, fog, etc.);
- the road markings are irregular or difficult to distinguish (e.g. partially erased, excessive spacing, distorted road surface...);
- being dazzled (glaring sun, lights of vehicles travelling in the opposite direction; etc.);
- the road is narrow, winding or undulating (tight bends, etc.);
- closely following a vehicle travelling in the same lane.

In this case, the "lane departure prevention" function may be activated incorrectly or not at all.

Risk of unwanted, incorrect correction or no correction of trajectory.

Deactivating the function

You must deactivate the function if:

- the camera area (on the windscreen side or the interior rear-view mirror side) or radar area(s) have been damaged;
- the road is slippery (snow, black ice, aquaplaning, gravel etc.) ;
- poor visibility (night, fog etc.) ;

ADDITIONAL DRIVING AID FUNCTIONS

- the windscreen is cracked or distorted (do not carry out windscreen repairs in this area; have it changed by an approved dealer);
- the vehicle is towing a trailer or a caravan;
- the vehicle is being towed (breakdowns);
- the vehicle is entering an area with several surface markings (an area with road works etc.) ;
- you are not driving on a paved road.

3

ADDITIONAL DRIVING AID FUNCTIONS

Blind spot warning

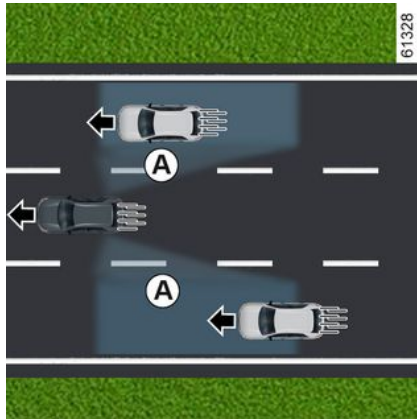

Using information from the sensors installed on each side of the rear bumper (area **C**), the function warns the driver:

- when a vehicle is in the blind spot area **A** and travelling in the same direction as your vehicle;
- and/or
- when there is a risk of collision with a vehicle that is in the **B** area and driving faster than you on an adjoining lane.

The function warns you when your vehicle is travelling at a speed above approximately 9 mph (15 km/h).

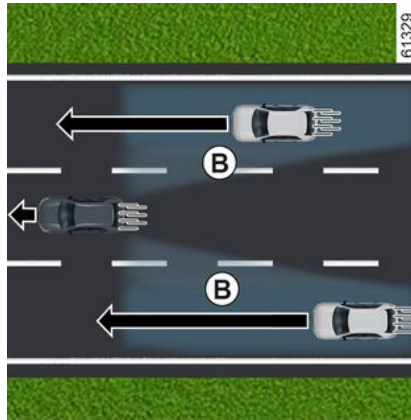

The function does not notify the driver if the other vehicles are not moving.



This function is an additional driving aid. This function is not under any circumstances intended to replace the due care and attention of the driver, who should at all times be in control of the vehicle.

Special feature



Ensure that zone **C** around the radars on each side of the rear bumper are not obstructed (by dirt, mud, snow, etc.).

If a radar is obscured, the "Side radars no visibility" message will appear on the instrument panel. Clean the area where the sensors are located.

ADDITIONAL DRIVING AID FUNCTIONS

Warning light 2



A warning light **2** is located on each door mirror **3**.

Note:

- clean the **3** rear view mirrors regularly, so that the indicator lights **2** can be seen properly;
- if you overtake another vehicle, the warning light **2** will only come on, if that vehicle remains for a long enough period in your vehicle's blind spot area **A**.

Display D

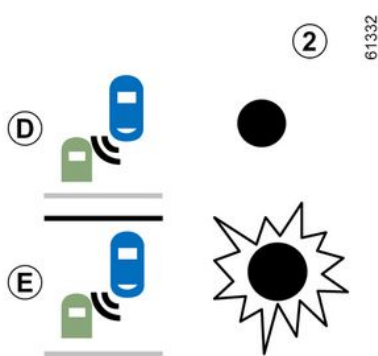

First warning: **direction indicator not activated**, the warning light **2** indicates that a vehicle is detected in the blind spot area and/or that a vehicle is rapidly approaching from the rear in an adjacent lane.

Display E

Direction indicator activated, the **2** warning light flashes when the function detects a vehicle in the blind spot warning area and/or a vehicle is rapidly approaching from the rear on the side towards which you will turn the wheel.

If you cancel the direction indicator, the function will return to the initial warning (display **D**).

Conditions for non-function

- When driving on a road with tight bends;
- in reverse.

If the vehicle is equipped with a towbar recognised by the system, the "Trailer: blind spot warning off" message is displayed on the instrument panel to inform you that the function is not operational.

For information on the range of equipment adapted to your vehicle, we advise you to consult an approved Dealer.

Operating faults

If the system detects a fault, the "Check Side radars" message is displayed on the instrument panel.

Consult an approved dealer.

ADDITIONAL DRIVING AID FUNCTIONS



Due to the presence of sensors behind the bumper, it is advisable to entrust any operation on the bumper (repair, replacement, paintwork, etc.) to a qualified professional.

ADDITIONAL DRIVING AID FUNCTIONS

Warnings



- The system's detection range operates according to a standard lane width. If you are driving in wide traffic lanes, the system might not be able to detect a vehicle in the blind spot.
- In the event of very bad weather conditions (heavy rain, snow, etc.), the system may be temporarily disrupted.

Remain aware of driving conditions.

There is a risk of accidents.



This function is an additional driving aid. This function is not under any circumstances intended to replace the due care and attention of the driver, who should at all times be in control of the vehicle.

The driver should always adapt their speed to the traffic conditions, regardless of the system indications.

The system should under no circumstances be taken to be an obstacle detector or an anti-collision system.

System servicing/repairs

- In the event of an impact, radar alignment may be changed, and its operation will consequently be affected. Consult an approved Dealer.
- Any work in the area where the radars are located (repairs, replacements, etc.) must be carried out by a qualified professional.

Only an authorised dealer is qualified to service the system.

System disturbance

Some conditions can disturb or damage the system's operation, such as:

- complex surroundings (metal bridges, tunnels, roads with barriers at the edge, etc.);
- poor weather conditions (snow, hail, black ice, etc.);
- the vehicle is fitted with a towbar that is not recognised by the system.

Risk of false alarms or absence of warnings

If the system behaves abnormally contact an authorised dealer.

ADDITIONAL DRIVING AID FUNCTIONS



Limitation of the system operation

- The radar area should be kept clean and free of any modifications in order to ensure the proper operation of the system.
- Small objects moving close to the vehicle (motorcycles, bicycles, pedestrians, etc.) may not be recognised by the system.
- When turning into a bend, the radars may temporarily cease to detect vehicles in adjacent lanes.
- The function may warn you late when two other vehicles are approaching from the rear, side by side in the adjacent lanes (driving on a 3-lane road) and at a much higher speed than your vehicle.
- The system may not provide a warning when the other vehicles are travelling at a significantly different speed.
- If the vehicle is being overtaken by a long vehicle (e.g. heavy goods vehicle overtaking at a similar speed to the vehicle) the system may interrupt the warning before the end of the manoeuvre.
- The vehicle is travelling on a winding road.

ADDITIONAL DRIVING AID FUNCTIONS

Safe distance alert

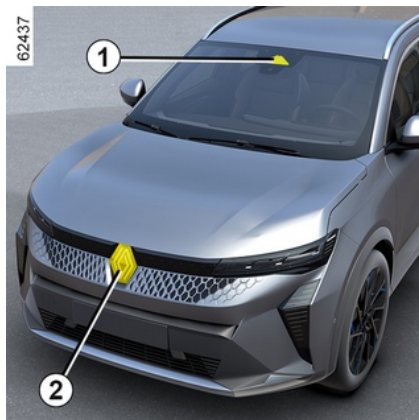

Using the information from the radar 2 and camera 1, this function informs the driver of the time interval between their vehicle and the vehicle in front so that a safe stopping distance between the two vehicles can be maintained.

The function is activated while the vehicle speed is between about 19 mph and 93 mph or 105 mph (30 km/h and 150 km/h or 170 km/h), depending on the vehicle.

Location of the camera 1

Make sure the windscreen is not obscured (by dirt, mud, snow, condensation etc.).

Location of the radar 2

Ensure that the radar area is not obstructed (by dirt, mud, snow, a badly fitted front number plate etc.), impacted, modified (including painting) or hidden by any accessory fitted on the front of the vehicle (on the grille or logo etc.).



This function is an additional driving aid. This function is not under any circumstances intended to replace the due care and attention of the driver, who should at all times be in control of the vehicle.

Activation/deactivation from the multimedia screen 3



From the "Vehicle" world on your multimedia screen 3, press the "Driving assistance" menu.

Activate or deactivate the "Following distance" function.



Each time the vehicle is started, the function continues the mode saved the last time the engine was stopped.

ADDITIONAL DRIVING AID FUNCTIONS

Operation

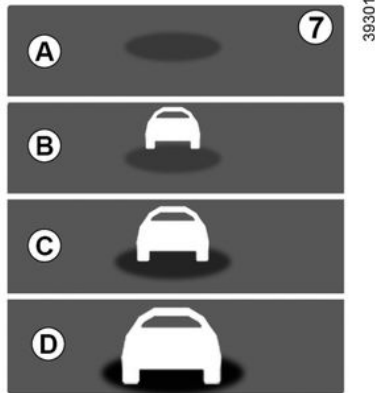

With the function activated, the **8** indicator is displayed on the instrument panel and informs the driver of the distance between their vehicle and the vehicle in front.

- **A** (grey): function not operational;
- **A** (green): no vehicle detected;
- **B** (green): the time interval is greater than or equal to around two seconds (distance between the two vehicles adapted to your speed);
- **C** (yellow): the time interval is between approximately 1 and 2 seconds (insufficient distance between the two vehicles);
- **D** (red): the time interval is less than or equal to around one second

(very insufficient distance between the two vehicles).

If the interval between the two vehicles is less than around 0.5 seconds, notification **8**, display **D**, will remain lit red on the instrument panel.

Under certain conditions, the time interval may not be displayed:

- while cornering;
- when changing lane;
- if the vehicle in front is sufficiently far or outside the range of the radar or camera.

ADDITIONAL DRIVING AID FUNCTIONS

Warnings



The measurement is displayed for information: the system does not carry out any action on the vehicle. This function is not designed for use in urban conditions or for a dynamic driving style (sudden cornering, acceleration, braking, etc.), but rather for stable driving conditions. The function does not interact with the braking system.

The radar and camera zones must be kept clean and free of any tampering in order to ensure the proper operation of the system.

Any work carried out in the area where the radar or camera is located (repairs, replacements, windscreen and/or bumper modifications, etc.) must be carried out by a qualified professional.

ADDITIONAL DRIVING AID FUNCTIONS



This function is an additional driving aid. This function is not under any circumstances intended to replace the due care and attention of the driver, who should at all times be in control of the vehicle.

System servicing/repairs

- In the event of an impact, the radar and/or camera alignment may be changed and its operation may consequently be affected. Deactivate the function and consult an authorised dealer.
- Any work carried out in the area where the radar and/or camera is located (replacements, repairs, windscreen and/or bumper modifications, etc.) must be carried out by a qualified professional.

Only an authorised dealer is qualified to service the system.

In the event of system disturbance

- obstruction of the windscreen or the bumper (by dirt, ice, snow, condensation etc.);
- a complex environment (metal bridge, tunnel, etc.);
- poor weather conditions (snow, hail, black ice, etc.);
- poor visibility (night, fog, etc.);
- poor contrast between the vehicle preceding it and the surrounding area (e.g. white vehicle in a snowy area, etc.);
- being dazzled (glaring sun, lights of vehicles travelling in the opposite direction; etc.);
- the road is narrow, winding and undulating (tight bends etc.)

Risk of erroneous false alarms.

ADDITIONAL DRIVING AID FUNCTIONS

Active emergency braking

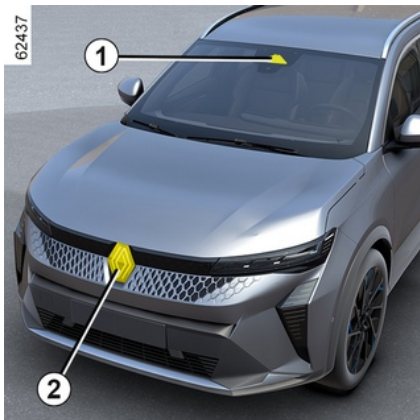

Using information from the camera **1** and the radar **2**, the system determines the distance between your vehicle:

– from the vehicle ahead in the same lane;

or

– from any oncoming vehicles in the context of a manoeuvre to change direction;

or

– and vehicles passing perpendicularly;

or

– and stationary vehicles;

or

– surrounding pedestrians and cyclists.

The system informs the driver if there is a risk of head-on collision to enable appropriate emergency manoeuvres (pressing the brake pedal and/or turning the steering wheel).

Depending on the reactivity of the driver, the system can assist with braking in order to limit damage or prevent a collision.

The system is otherwise inactive and does not trigger an alert.



This function is an additional driving aid.

This function is not under any circumstances intended to replace the due care and attention of the driver, who should at all times be in control of the vehicle.



This system can apply maximum braking to the vehicle until it is completely stationary if necessary.

For safety reasons, always wear your seat belt when travelling in your vehicle and make sure that it is loaded so that no items can be thrown forward and hit the occupants.

For safety reasons, always wear your seat belt when travelling in your vehicle and make sure that it is loaded so that no items can be thrown forward and hit the occupants.

Location of the camera **1**

Make sure the windscreen is not obscured (by dirt, mud, snow, condensation etc.).

Location of the radar **2**

Make sure that the area around the radar is not obscured (by dirt, mud, snow or an incorrectly fitted number plate), impacted, altered (including paintwork) or hidden.

Operation

When driving, when there is a risk of collision, the system:

– **alerts you of a collision risk:** the "Detected obstacle" message appears on the instrument panel accompanied by a beep.

ADDITIONAL DRIVING AID FUNCTIONS

Note: if the driver presses the brake pedal and the system still detects a risk of collision, the braking force may be increased if it is not sufficient to prevent the collision.

– **can trigger braking:** if the driver does not react to the alert and the collision becomes imminent, the red warn-

ing light  and the "Brake" message are displayed on the instrument panel accompanied by a sound signal.

Note:

– if the driver uses the vehicle controls (steering wheel, pedals, etc.) the system may delay its reaction or not activate;

– if active emergency braking has caused the vehicle to stop, the vehicle is kept stationary for a short time. Beyond this time limit, the driver must keep the vehicle stationary by holding their foot on the brake pedal;

– after the system activates braking, the "Advanced Safety triggered" message will be displayed



In the event of an emergency manoeuvre, you can stop the braking at any moment by:

- tapping the accelerator pedal;
- or
- turning the steering wheel as a collision avoidance manoeuvre.



Special features of warnings

Depending on the speed, the warning and braking may be activated simultaneously.

Vehicle detection

Detection of vehicles travelling in the same lane

A risk of a collision with the vehicle in front of you in the same lane is detectable by the system when the vehicle is travelling at a speed over approximately 5 mph (8 km/h).

Detection of oncoming vehicles in the context of a manoeuvre to change direction

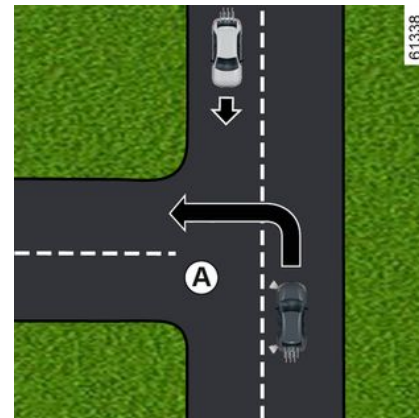

When you wish to change direction (e.g. **A**), oncoming vehicles are detected by the system when:

- your vehicle is travelling at a speed between approximately 5 mph (8 km/h) to 12 mph (20 km/h);
- you have activated the direction indicator light.

Detection of vehicles crossing the lane perpendicularly

Vehicles crossing the lane perpendicularly are detected by the system when:

- your vehicle is travelling at a speed between approximately 12 mph (20 km/h) and 37 mph (60 km/h).

Detection of vehicles stopped in the lane

ADDITIONAL DRIVING AID FUNCTIONS

Stationary vehicles are detected by the system when:

– your vehicle is travelling at a speed between approximately 5 mph (8 km/h) and 50 mph (80 km/h).

3 **Detection of pedestrians and cyclists**

Detection of pedestrians and cyclists in the same lane

The system detects pedestrians and cyclists when:

– your vehicle is travelling at a speed between approximately 5 mph (8 km/h) and 53 mph (85 km/h).

Detection of pedestrians and cyclists when changing direction

The system detects pedestrians and cyclists when:

– your vehicle is travelling at a speed between approximately 5 mph (8 km/h) and 12 mph (20 km/h).

Activation/deactivation

 Depending on the vehicle, according to the length of time following the last time the engine was stopped, the function is reactivated:

- when the vehicle is unlocked;
- or
- when a door is opened;
- or
- when the engine is restarted.

Activating, deactivating the system from the multimedia screen 3



To activate or deactivate the function, refer to the multimedia instructions. Select "ON" or "OFF".

Settings



For safety reasons, carry out any adjustments while the vehicle is stationary.

Settings from the multimedia screen 3

ADDITIONAL DRIVING AID FUNCTIONS



With the vehicle stationary, to access the function settings from the multimedia screen **3**, refer to the multimedia instructions:

"Warning anticipation": adjust the alert sensitivity level. To do this select:

- « Late » ;
- « Standard » ;
- « Early ».

Please refer to the multimedia instructions for more information.

Temporarily not available

If the system detects a temporary fault,

the  warning light appears on the instrument panel.

The possible causes are:

- the system is temporarily blinded (glare from the sun, dipped beam headlights, bad weather conditions etc.). The system will be operational again when visibility conditions are better;
- the system is temporarily interrupted (e.g. the windscreen, front or rear bumper or logo is obscured by dirt, mud, snow, condensation, etc.) In this case, park the vehicle and switch off the engine. Clean the windscreen, the front bumper or the logo. The next time the engine is started, after around five or ten minutes of driving, the warning light and the message disappear. If this is not the case, this may arise from another cause; contact an Approved Dealer.

Operating faults

If the system detects a temporary fault,

the  warning light appears on the instrument panel. Consult an approved dealer.

ADDITIONAL DRIVING AID FUNCTIONS

Warnings



This function is an additional driving aid. This function is not under any circumstances intended to replace the due care and attention of the driver, who should at all times be in control of the vehicle.

The triggering of this function may be delayed or prevented when the system detects clear signs of control of the vehicle by the driver (action on the steering wheel, pedals etc.).

The system cannot be activated when:

- the gear control is in Neutral position;
- the Electronic Stability Control (ESC) has been triggered.

System servicing/repairs

- In the event of an impact, the radar and/or camera alignment may be changed and its operation may consequently be affected.
Deactivate the function and consult an authorised dealer.
- Any work in the area where the radar and/or camera is located (repairs, replacements, windscreen modifications, etc.) must be carried out by a qualified professional.

Only an authorised dealer is qualified to service the system.

ADDITIONAL DRIVING AID FUNCTIONS



System disturbance

Some conditions can disturb or damage the system's operation, such as:

- a complex environment (metal bridge, tunnel, etc.);
- poor weather conditions (snow, rain, hail, black ice, etc.);
- poor visibility (night, fog, etc.);
- poor contrast between the object (vehicle, pedestrian etc.) and the surrounding area (e.g. pedestrian dressed in white located in a snowy area etc.);
- being dazzled (glaring sun, lights of vehicles travelling in the opposite direction; etc.);
- windscreen obscured (by dirt, ice, snow, condensation etc.);
- ...

In these conditions, the system may not react, may warn the driver or may brake inadvertently.

Limitation of the system operation

- Each time the vehicle is started, the system carries out a calibration according to the vehicle surroundings and may be inactive for a length of time between approximately two to five minutes of driving;
- the radar and camera zones must be kept clean and free of any modifications in order to ensure the proper operation of the system;
- the system may not respond to small vehicles such as motorbikes as effectively as to other vehicles;
- the system may not operate properly when the road surface is slippery (rain, snow, black ice, etc.);
- to ensure correct operation, the system needs to distinguish the entire obstacle. So the system cannot detect:
 - pedestrians/cyclists in the darkness or in poor lighting conditions;
 - partially visible pedestrians/cyclists;
 - pedestrians less than approximately 80 cm;
 - pedestrians carrying large objects;
 - ...

In these conditions, the system may not react, may warn the driver or may brake inadvertently.

ADDITIONAL DRIVING AID FUNCTIONS



Deactivating the function

You must deactivate the function if:

- the camera area has been damaged (e.g. on the inside or outside of the windscreen);
- the front of the vehicle has been damaged (impact, distortion, scratch on the radar, etc.);
- the vehicle is being towed (breakdowns);
- the windscreen is cracked or distorted (do not carry out windscreen repairs in this area; have it changed by an approved dealer);
- you are not driving on a paved road.

In the event of the system behaving abnormally, deactivate it and consult an authorised dealer.

Halting the function

You can halt the active braking function at any time by tapping the accelerator pedal or by turning the steering wheel in a collision avoidance manoeuvre.

ADDITIONAL DRIVING AID FUNCTIONS

Driver vigilance warning

The driver vigilance warning is a function that analyses the behaviour of the driver (driving style, vehicle steering, etc.) and alerts them if there is a risk of falling asleep.

It takes into account indicators such as:

- steering wheel movements;
- driver actions on other systems (indicators, brake pedal, etc.).



This function is an additional driving aid in case of risk of fatigue. The function does not operate on the vehicle. The function cannot, under any circumstances, replace the driver's responsibility during driving.

The driver must always adapt their driving according to their alertness, regardless of the system's indications.

Operation



The function is set to notify the driver if:

- a few minutes have elapsed since the vehicle last stopped;
- the vehicle speed is greater than approximately 43 mph (70 km/h).

If there is a risk of fatigue or impaired attention, the "Vigilance alert Have a break" **1** message is displayed on the instrument panel, accompanied by a beep.

Press switch **2 OK** to delete the warning.

After deleting the message, the system continues vigilance monitoring and issues a new warning if necessary.



The driver vigilance warning constantly monitors the driver's attention and can provide several warnings per journey. The system resets every time the engine is started.

Activation/deactivation



For safety reasons, carry out any adjustments while the vehicle is stationary.





Depending on the vehicle, depending on the length of time following the last time the engine was stopped, the alerts are reactivated:

- when the vehicle is unlocked;
- or
- when a door is opened;
- or
- when the engine is started.

ADDITIONAL DRIVING AID FUNCTIONS

3  When the alerts are deactivated, the system continues to assess the driver's state of fatigue.

3  Depending on the vehicle, alerts are automatically deactivated when the "Lane Centring" function is activated. To re-activate the warnings, the "Lane Centring" function must be deactivated. For more information → 233.

3  Depending on the vehicle, it may not be possible to deactivate alerts.

Activating and deactivating alerts using the "My Safety" button **3**



The alerts can be deactivated or activated using "Custom" mode in the "My Safety" function → 196.

If the alerts have previously been deactivated using Custom mode:

- **to deactivate the alerts**, press the button **3** twice. The indicator light on the button **3** goes out;
- **To reactivate the alerts**, press the button **3** once. The indicator light on the button **3** lights up.

Activating and deactivating the alerts from the multimedia screen **4**



To activate or deactivate the alerts, please refer to the multimedia instructions.

Select "ON" or "OFF".

Limitations of system operation

Some conditions can disrupt or damage the system operation, for example:

- certain driving styles (incorrect driving etc.);
- driving on a road in poor condition;
- strong side wind;
- The clock is wrongly configured (depending on vehicle);

ADDITIONAL DRIVING AID FUNCTIONS

- winding roads;
- trailer traction.

Operating faults

If the system detects a fault, the "Check Fatigue Warning System" mes-

sage and the  warning light are displayed on the instrument panel.

Have the system checked by an authorised dealer.

Detection of road signs

Introduction

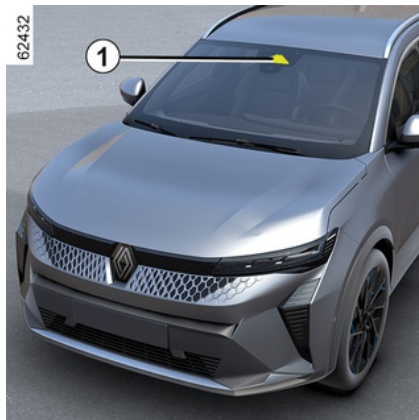

The system displays speed limits on the instrument panel according to road signs detected on the side of the road.

It mainly uses information taken from the camera **1** attached to the windscreen behind the rear view mirror. Depending on the country, the system also uses information from a map subscription to interpret certain signs (town entrance, etc.).

The sign displayed on the instrument panel changes when a road sign is detected by the system.

Once the speed limiter is activated, you can adapt the limited speed set-point to the speed limit displayed on the instrument panel by the system (→ **251**).

If the detected speed limit is exceeded, the road sign displayed on the instrument panel is modified to inform the driver.

Location of the camera **1**

Make sure the windscreen is not obscured (by dirt, mud, snow, condensation etc.).

Special features

For vehicles with a map subscription:

- if the vehicle is travelling in a country where the speed units differ from those

of the vehicle, the system displays the speed limit sign in the unit of the country, alongside the speed limit converted to the unit used by the vehicle's instrument panel.

- for countries where the speed limit is reduced during rainy weather on some types of roads, the system may alter the detected speed limit after a few seconds of the windscreen wipers being activated.

For vehicles without a map subscription: when driving in a country where speed units differ from those on your vehicle, you can manually select the speed unit shown on the instrument panel (e.g. change the unit from miles to kilometres) in order to display accurate information → **133**.

Note: the system does not take into account exceptional speed limit measures, such as on peak pollution days.

ADDITIONAL DRIVING AID FUNCTIONS

Operation



Warning lights

The function displays the following warning lights:

2. Speed limit signs and additional speed limit signs (speed on exit ramp with arrow, speed with a caravan, speed limit with length of application, etc.)

3. Additional road signs (start of no overtaking zone).

If the detected speed limit is exceeded, a circle flashes around the road sign (warning light **2**) accompanied, depending on the vehicle, by a beep emitted for a few seconds to warn you.

It remains illuminated on the instrument panel as long as the vehicle is exceeding the detected speed limit.



Map subscription

Road sign detection is associated with a map subscription.

To manage the subscription, please refer to the multimedia instructions.

If there is no subscription, the system will be limited to taking into account the speed limit signs when they are detected by the camera.

The system will no longer take into account information related to the maps. The speed limit availability may be affected.

Activation/deactivation



For safety reasons, carry out any adjustments while the vehicle is stationary.



Depending on the length of time following the last time the engine was stopped, the sound alert is reactivated:

- when the vehicle is unlocked; or
- when a door is opened; or
- when the engine is restarted.

Activating, deactivating the overspeed sound alert using the "My Safety" button **4**



ADDITIONAL DRIVING AID FUNCTIONS

The sound alert can be deactivated or activated using "Custom" mode in the "My Safety" function → 196.

If the sound alert has previously been deactivated using "Custom" mode:

- **to deactivate the sound alert**, press the button **4** twice. The indicator light on the button **4** goes out;
- **to reactivate the sound alert**, press the button **4** once. The indicator light on the button **4** lights up.

Activating, deactivating the over-speed sound alert from the multimedia screen **5**



To activate or deactivate the sound alert, please refer to the multimedia instructions.

Select ON or OFF.

Variation of the limited speed or cruising speed



To adapt the speed limiter, cruise control or adaptive cruise control setpoint to the detected speed limit, press the **6** switch.

Temporary unavailability

If the system is unavailable for reasons related to the camera or map data, the



symbol or, depending on the ve-

hicle, the  symbol is displayed on the instrument panel. If there is still a problem, contact an approved dealer.

The system cannot detect the speed limit if:

- the windscreen is not clean;
- the camera is blinded by the sun;
- there is insufficient visibility (fog, etc.);
- the signs are not legible (snow, etc.) or are hidden (by another vehicle or by trees);
- the information taken from the map is not up to date.

Note: when the front camera is obscured, the "Front camera no visibility" message is displayed on the instrument panel. Clean the windscreen area in front of the camera.

Operating faults

When the system detects an operating

fault, the  or, depending on the

vehicle,  symbol is displayed on the instrument panel.

In some cases, they are accompanied by the following message:

- "Driving aids unavailable";
- or
- "Check front camera";
- or
- "Check driving aids".

Consult an approved dealer.

ADDITIONAL DRIVING AID FUNCTIONS

Warnings



This function is an additional driving aid. This function is not under any circumstances intended to replace the due care and attention of the driver, who should at all times be in control of the vehicle.

The driver should always adapt their speed to the traffic conditions, regardless of the system indications.

The system detects maximum speed limit signs and does not detect other signs (e.g. entry/exit to/from urban areas).

The system may not detect all speed limit signs or may interpret them incorrectly.

The driver must not ignore road signs undetected by the system and should give priority to complying with the actual road signs and the highway code.

In the event of poor visibility (fog, snow, frost, etc.), it is possible that the system may not indicate the correct speed to the driver.

ADDITIONAL DRIVING AID FUNCTIONS

Active driver assist

Introduction

The "Active driver assist" is a driving aid system for use outside built-up areas, on wide roads with visible lines.

The system consists of the "**Adaptive cruise control/Stop and Go**" → 255 and "**Lane centring**" functions.

This system enables the driver to:

- maintain vehicle speed based on a previously stored speed;
- adjust the distance between their vehicle and the vehicle in front;
- direct the trajectory of the vehicle in the lane;
- adapt the vehicle speed to the speed shown on the road signs, automatically or after confirmation by the driver (depending on the vehicle).

The Stop and Go adaptive cruise control function.

Depending on the country and subscription, based on information from a radar, camera or map data sent via a GSM connection, the Stop and Go adaptive cruise control makes it possible to maintain a selected speed, known as the cruising speed, while keeping a safe distance from the vehicle in front in the same lane.

The cruising speed can adjust automatically to a speed limit change (depending on the country and subscription).

If the vehicle in front stops, the Stop and Go adaptive cruise control may brake your vehicle to a complete stop before setting off again.



Important: you should keep your feet near the pedals and your hands on the steering wheel at all times to prepare for any event.

The system controls acceleration and deceleration of your vehicle using the engine and braking system.

The Stop and Go adaptive cruise control function can be activated from 0 mph, according to conditions on the road (traffic, weather, etc.).

It is represented by the  → 255 symbol.

Note:

– the driver must observe the maximum speed limit and safe distances according to the legislation in the country where they are driving;

– the adaptive cruise control can brake the vehicle up to a third of the braking capacity. Depending on the situation, the driver may need to brake harder.



The Stop and Go adaptive cruise control does not trigger an emergency stop and its braking capability is limited.

The Lane Centring function

Using information from a camera, the "Lane Centring" function manipulates the steering system to direct the vehicle in the lane.

If the conditions allow it, the function is available between:

– 0 mph and a speed between 99 mph (160 km/h) and 112 mph (180 km/h) (depending on the version) with a vehicle in front;

or

– 37 mph (60 km/h) and a speed between 99 mph (160 km/h) and 112 mph (180 km/h) (depending on the version) without a vehicle in front.

The "Lane Centring" function is a comfort feature.

ADDITIONAL DRIVING AID FUNCTIONS

It is represented by the  warning light.

Note: in the event of a sharp bend, the function's lateral retention capacities are limited and require the driver to take immediate action on the steering wheel.

Additional information

Depending on the vehicle, the "Active driver assist" function may be used with other driving aid functions.

Please note that:

- When the "Lane Centring" function is in adjustment mode, this will suspend the "Lane departure prevention" function if it has already been activated. When the "Lane Centring" function is not controlling the steering system, the "Lane departure prevention" function may be reactivated if conditions allow.

ADDITIONAL DRIVING AID FUNCTIONS

Location of components

3

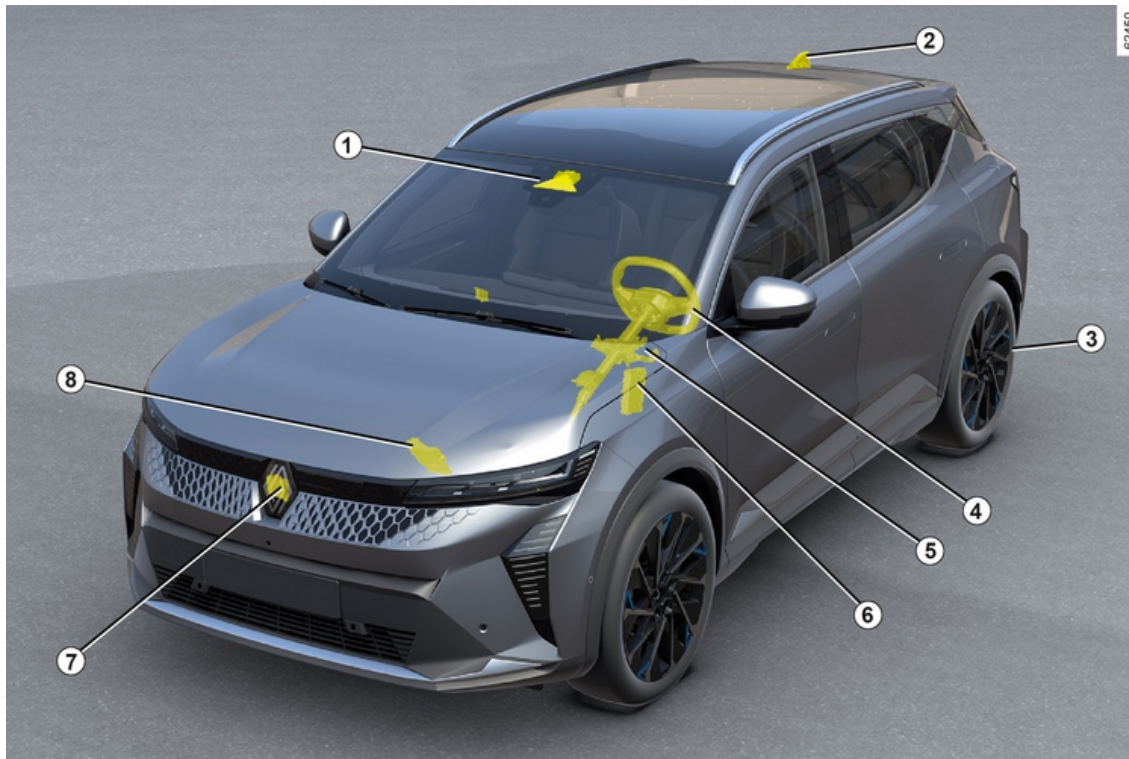

ADDITIONAL DRIVING AID FUNCTIONS

1 Camera

Detects markings on the ground and the position of vehicles on the various traffic lanes.

It receives information from the radar **6** and merges it with its own information to determine the trajectory and speed of the vehicle (acceleration/braking). Amongst other things, it controls the system activation/deactivation parameters (door opening status, etc.).

Depending on the vehicle, it processes information to detect the presence of the driver's hands on the steering wheel.

Make sure the windscreen is not obscured (by dirt, mud, snow, etc.).

2 Aerial and maps

(depending on the country and sub-description)

Road maps and certain driving conditions (roundabouts and cornering) are downloaded according to the journey taken by the vehicle. The system can anticipate deceleration following a change of the speed limit indicated on road signs, depending on the parameters selected by the driver.

The system can also adjust the vehicle's speed when approaching a tight bend or roundabout.

3 Electronic parking brake

It the vehicle stationary under certain

conditions.

4 Capacitive sensor

Depending on the vehicle, it detects hands on the steering wheel.

5 Power-assisted steering

It operates the front wheels to guide the vehicle trajectory according to the information transmitted by the computer **1**.

6 Engine computer

It controls and directs the engine to carry out the required acceleration.

7 Radar

Calculates the distance between your vehicle and the vehicle in front.

The system's maximum range is approximately 150 metres. This may vary according to the road conditions (ground relief, weather conditions, etc.)

Ensure that the radar area is not obstructed (dirt, mud, snow, a badly fitted front number plate), impacted, modified (including painting) or hidden by any accessory fitted on the front of the vehicle (on the grille or logo etc.).

8 Active vehicle control

This system provides information on vehicle dynamics to the computer **1** (speed, lateral acceleration, etc.) and acts on the braking system to control deceleration and to keep the vehicle stationary.



The radar and camera zones must be kept clean and free of any tampering in order to ensure the proper operation of the system.

ADDITIONAL DRIVING AID FUNCTIONS

Controls

3

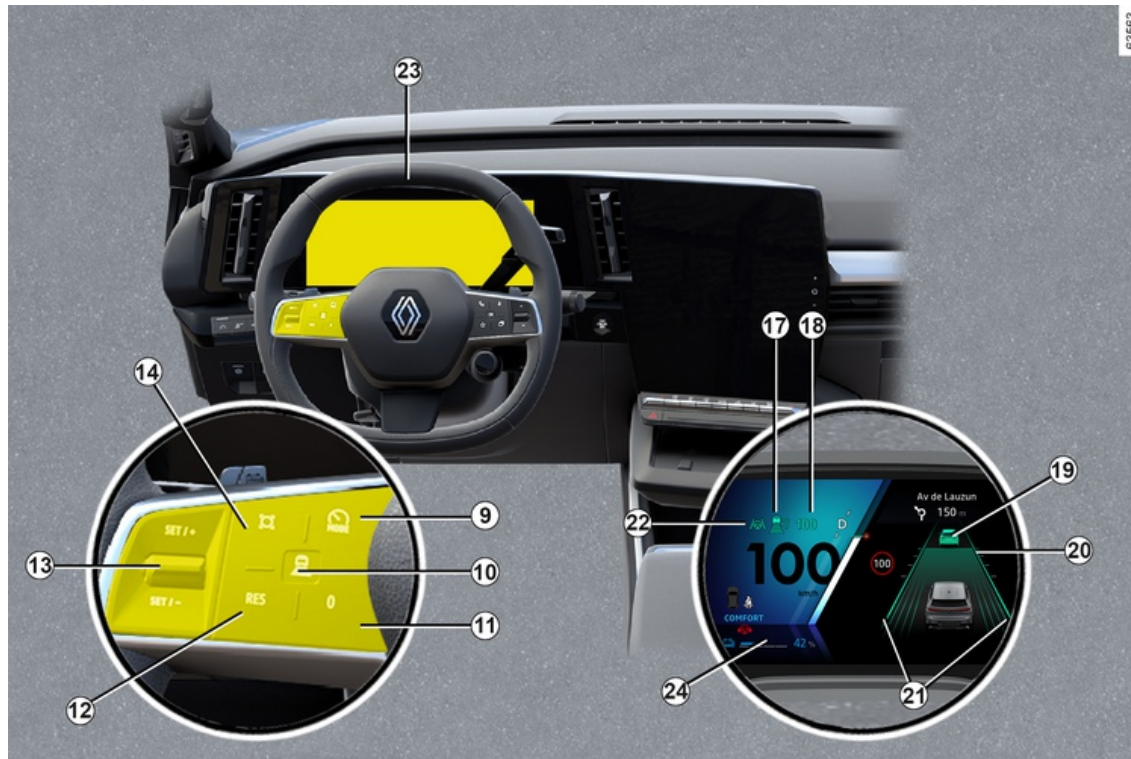

63563

ADDITIONAL DRIVING AID FUNCTIONS

9. Switch for selecting/deselecting the driving aids, depending on the vehicle:

- the Active driver assist;
- Adaptive Cruise Control;
- speed limiter;
- OFF.

10. Safe distance settings

11. Puts the function on standby and stores the limited speed (0).

12. Recall the stored cruising speed (RES).

13.

- Upwards: activates, increases cruising speed or stores the current speed (SET/+).
- Downwards: activates, decreases cruising speed or stores the current speed (SET/-).



14. Pop-up button (depending on the vehicle): adapts the speed setpoint to

detected speed limits  → 229

If the "OFF" mode is selected before switching off the engine, the "Speed limiter" function will be activated by default the next time the engine is started.

ADDITIONAL DRIVING AID FUNCTIONS

Displays on the instrument panel

17. Stop and Go adaptive cruise control function warning light .
18. Stored cruising speed.
19. Vehicle in front.
20. Stored safe distance
21. Left-hand and right-hand line indicators
22. "Lane Centring" function warning light .

Steering wheel 23

The driver must always keep their hands on the steering wheel.

If the driver turns the steering wheel with enough force, the "Lane Centring" function is interrupted to enable the driver to regain control of the vehicle.

Under certain conditions (sharp bends, etc.) a vibration may be triggered on the steering wheel to warn the driver that they must regain control of the vehicle.

If the driver does not handle the steering wheel (no hands are detected) the "Lane centring" function is deactivated after several visible and audible alerts.

Activating/deactivating the "Active driver assist" function

Activating the function



To activate the function, press the switch **9** as many times as necessary to activate it.

The warning light **22**  is displayed in grey on the instrument panel. Then press the steering wheel control **13** upwards (SET/+) or downwards (SET/-).

The "Active driver assist", consisting of the Adaptive cruise control Stop and Go and the "Lane Centring" function, is then activated.

The green warning light **22**  and the left-hand and right-hand line indicators **21** are displayed on the instrument panel to confirm that the function is in operation and directing your vehicle towards the centre of the lane.

You can interrupt the "Lane Centring" function at any time by forcefully turning the steering wheel. As soon as you stop turning the steering wheel, the "Lane Centring" function is reactivated.

Note: you must keep your hands on the steering wheel when using the "Lane Centring" function. Under no circumstances should you take your hands off the steering wheel.

Deactivating the function

Press the switch **9**. Deactivation of the function is confirmed by the disappearance

of the warning light **22**  and the right-hand and left-hand line indicators **21** from the instrument panel.

Note: if the "Lane departure prevention" function was previously activated and the conditions allow, it will automatically reactivate.

ADDITIONAL DRIVING AID FUNCTIONS



To exit the driving aids, press switch **1** as many times as necessary until you reach OFF. The "Driving Assistance deactivated" message appears on the instrument panel. In this case, the next time the engine is started, the "Speed limiter" function will be activated and waiting for a speed limit to be stored.

Adjusting the position in the lane

(depending on the vehicle)



To activate the position in the lane, the "Lane Centring" function must be in adjustment mode, the green warning light **22** must be displayed on the instrument panel and the vehicle speed must be below 31 mph (50 km/h).

In these conditions, you can adjust your position in the lane by turning the steering wheel slightly to the right or left, so that the vehicle shifts to the selected side without the "Lane Centring" function being deactivated. As soon as your offset is at least about 15 cm from the middle of the lane, without the vehicle approaching less than about 30 cm from the edge of the lane, you have about 10 seconds to adjust the offset precisely. The vehicle then remains in the offset position when you stop exerting effort to turn the steering wheel. The lines **21** indicate the offset applied. To return to the centre of the lane, turn the steering wheel slightly in the opposite direction, then stop trying once the vehicle has reached the centre.

According to certain conditions (e.g. bend, speed), the vehicle may be re-centred automatically.

"Lane Centring" function on stand-by

The "Lane Centring" function is put on standby automatically in the following cases:

- the system no longer detects the lines or only one line is detected in your lane;
- the lane is too narrow or too wide;
- the system does not detect any hands on the steering wheel;
- in some driving conditions (roundabout, intersection, the bend is too sharp, etc.);
- the vehicle speed is greater than approximately 99 mph or 112 mph (160 km/h or 180 km/h), depending on the vehicle;
- the vehicle speed is below approximately 28 mph (45 km/h), without any vehicle in front;
- the vehicle crosses a line;
- the system is temporarily disrupted (for example: camera obscured by dirt, mud, snow, condensation, etc.).

Certain actions carried out by the driver also suspend the "Lane Centring" function:

- activating the indicators;
- turning the steering wheel with enough force.

The function is confirmed to be on standby by the appearance of the grey

ADDITIONAL DRIVING AID FUNCTIONS

warning light **22**  and the left-hand and right-hand line indicators **21** on the instrument panel.

3



Important: you should keep your feet near the pedals and your hands on the steering wheel at all times to prepare for any event.

Once the conditions are met, the function again directs the vehicle in the

lane. The warning light **22**  and the left-hand and right-hand line indicators **21** are displayed in green on the instrument panel.



You can affect **the vehicle trajectory** at any point by turning the steering wheel.

"Keep hands on steering wheel" warning



When the "Lane Centring" function no longer detects your hands on the steering wheel, several warning levels will be triggered:

- **after approximately 15 seconds**, the "Keep hands on steering wheel" message appears in yellow on the instrument panel;
- **after approximately 35 seconds**, if the driver does not put their hands on the steering wheel after the warning is displayed, an audible warning sounds continuously. The brakes are then briefly applied repeatedly to inform the driver that they must retake control of the vehicle by putting their hands on

the steering wheel. If the driver does not respond, the "Active driver assist" activates the hazard warning lights and slows down the vehicle until it comes to a complete stop.



The driver can interrupt this manoeuvre at any time by placing their hands on the steering wheel, braking or deactivating the "Active driver assist".

– After the vehicle has stopped, the electronic parking brake is automatically applied, the warning lights stay

on, the warning light **24**  goes out and the "Lane centering deactivated" message appears in red on the instrument panel to inform you.



In the first two alert levels, when the system again detects the presence of the driver's hands on the steering wheel, the system stops the alerts. The function continues to direct the vehicle in the lane.

ADDITIONAL DRIVING AID FUNCTIONS

Note: in some situations, the "Lane Centring" function may no longer detect your hands on the steering wheel and may emit an alert:

- the driver is holding the steering wheel very lightly;
- the driver is wearing gloves;
- ...



Warning concerning the capacitive sensor: fitting any accessory on the steering wheel is prohibited (protective cover, etc.).

In the case of a sharp bend

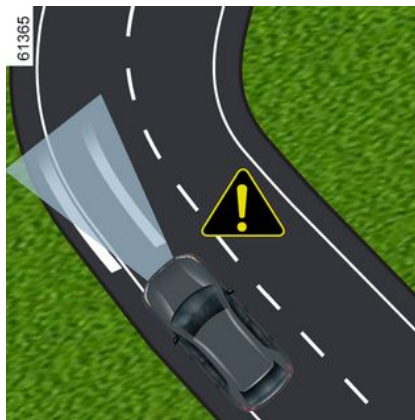

In the case of a sharp bend, and depending on the vehicle speed, the function's side retaining capacities will be limited and require the driver to carry out immediate action on the steering wheel so that the vehicle remains in the lane.

If the driver does not intervene, the function triggers the vibration of the steering wheel to signal that the vehicle is about to breach a line and that the driver needs to carry out immediate action.

The warning light **22**  and the left-hand or right-hand line indicator **21**

concerned appear in red on the instrument panel.

If the vehicle crosses a line completely and moves out of its lane or if the bend is too sharp, the "Lane Centring" function is put on standby.

The function is confirmed to be on standby by the appearance of the grey

warning light **22**  and the left-hand and right-hand line indicators **21** on the instrument panel.



The "Lane Centring" function cannot assist the driver when negotiating a roundabout or an intersection and may automatically switch to standby. In all cases, the driver must always turn the steering wheel to manage the vehicle trajectory under these driving conditions.

Operating faults

If an operating fault is detected in relation to the "Lane Centring" function, the "Driving assist unavailable" or "Check Driving assist" message is displayed on the instrument panel and the function is deactivated.

ADDITIONAL DRIVING AID FUNCTIONS

Consult an approved dealer.

3

ADDITIONAL DRIVING AID FUNCTIONS

Warning



The "Active driver assist" is an additional driving aid. It can under no circumstances replace the driver's responsibility to respect speed limits and safe distances and to be vigilant.

The driver must always be in control of the vehicle.

The driver must always adapt their trajectory and speed according to the surroundings and driving conditions, regardless of system indications.

Except for lines delimiting lanes and the speed limit signs within the limits of the system's detection capacity, the road sign information (other traffic signs, traffic lights, pedestrian crossings, etc.) are not recognised by the system. These do not trigger any alert or reaction by the system.

The "Active driver assist" uses the "Stop and Go adaptive cruise control" and "Lane Centring" functions. The system should under no circumstances be taken to be an obstacle detector or an anti-collision system.

Use the "Active driver assist" exclusively outside built-up areas, on wide roads with visible lines.

It must not be used in heavy traffic, on winding or slippery roads (black ice, aquaplaning, gravel) or during bad weather (fog, rain, side winds etc.).

There is a risk of accidents.

System servicing/repairs

– In the event of an impact, the radar and/or camera alignment may be changed and its operation may consequently be affected. Deactivate the system and consult an authorised dealer.

– Any work in the proximity of the radar and/or camera (replacements, repairs, windscreen modifications, paintwork etc.) must be carried out by a qualified professional.

Only an authorised dealer is qualified to service the system.

ADDITIONAL DRIVING AID FUNCTIONS



Deactivating the system

You must deactivate the system if:

- the vehicle is travelling on a winding road;
- the vehicle is being towed (breakdowns);
- the vehicle is towing a trailer or a caravan;
- the vehicle is being driven in a tunnel or close to a metallic structure;
- the vehicle arrives at a toll point, a roadwork area or on a narrow lane;
- the vehicle is being driven up or down a very steep slope;
- the visibility is poor (glaring sun, fog, etc.);
- the weather conditions are poor (rain, snow, side winds, etc.);
- the vehicle is being driven on a slippery road surface (rain, snow, gravel, etc.);
- the camera area has been damaged (e.g. interior or exterior windscreen area); the windscreen is cracked or distorted;
- the radar area has been damaged (impacts, etc.);
- the surface of the steering wheel is damaged or damp.

In the event of the system behaving abnormally, deactivate it and consult an authorised dealer.

ADDITIONAL DRIVING AID FUNCTIONS



Some conditions can disrupt or damage the system operation, for example:

- obstruction of the windscreen or the radar area (by dirt, ice, snow, condensation etc.) Frequently check the cleanliness and condition of the windscreen, front wiper blades and front bumper;
- a complex environment (tunnel, etc.);
- poor weather conditions (snow, heavy rain, hail, black ice, etc.);
- poor visibility (night, fog, etc.);
- poor contrast between the vehicle preceding it and the surrounding area (e.g. white vehicle in a snowy area, etc.);
- being dazzled (glaring sun, lights of vehicles travelling in the opposite direction; etc.);
- narrow, winding or undulating road (tight bends, etc.);
- the tar lines detected as a line by the system;
- narrowing/widening lanes;
- road markings which are worn, lacking in contrast or very widely spaced from one another (lines partially erased; etc.);
- multiple markings on the road (roadworks area, slip roads connecting to adjacent motorways, hard shoulder, etc.);
- road signs that do not include an arrow, located on a motorway exit;
- an area with low connectivity that makes it impossible to geolocate the vehicle, or maps that are not up-to-date;
- a vehicle with a significant difference in speed;
- use of mats not adapted to the vehicle. On the driver's side, only use mats suitable for the vehicle, attached with the pre-fitted components, and check the fitting regularly. Do not lay one mat on top of another. **There is a risk of wedging the pedals.**

In these cases:

- **Risk of unwanted braking or acceleration.**
- **Risk of unwanted, incorrect correction or no correction of trajectory.**

Many unforeseen situations may affect the system operation. Certain objects or vehicles that can appear in the camera or radar detection zone may be interpreted by the system incorrectly, possibly leading to inappropriate acceleration or braking. **You should always be attentive to sudden events that might occur while you are driving. Always maintain your vehicle under control by keeping your feet near the pedals and your hands on the steering wheel, so that you are ready to act in any event.**

ADDITIONAL DRIVING AID FUNCTIONS

Active emergency braking in reverse gear

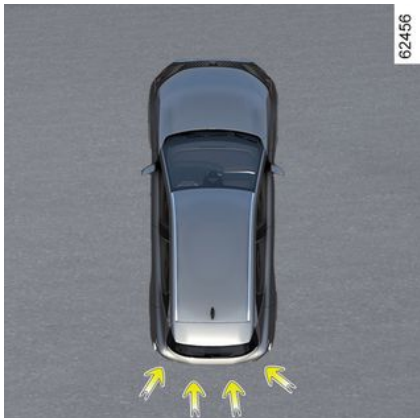

In addition to the "Parking assistance" → 272 function and using information from the four central sensors located at the rear of the vehicle, the system detects fixed obstacles located behind your vehicle. If there is a significant risk of collision, the system automatically causes the vehicle to brake.

Note: make sure that the four central sensors located at the rear of the vehicle are not obscured (by dirt, mud, snow, etc.).

Operation



Fixed rear obstacle detection

When in reverse gear and moving at between approximately 2 mph and 6 mph (3 km/h and 10 km/h), if there is a risk of collision with a fixed obstacle, the system **automatically brakes the**

vehicle. A visual warning  2 is displayed on the multimedia screen 1, accompanied by a beep.

Once the vehicle has stopped, the vehicle must be held stationary by the driver keeping their foot on the brake pedal.



This function is an additional driving aid. This function is not under any circumstances intended to replace the due care and attention of the driver, who should at all times be in control of the vehicle.



An impact to the underside of the vehicle while manoeuvring (e.g. striking a post, raised kerb or other street furniture) may result in damage to the vehicle (e.g. deformation of an axle). To avoid any risk of accident, have your vehicle checked by an approved dealer.

ADDITIONAL DRIVING AID FUNCTIONS

Activating or deactivating the system



To activate or deactivate the function via the multimedia screen **1**, select the "Vehicle" world, then "Parking assistance". Select "Rear Active Emergency Braking".

If the function is deactivated, the  warning light **3** is displayed on the multimedia screen.

Operating faults

When the system detects an operating fault, active emergency braking in reverse gear is automatically deactivated.

The  warning light **3** is displayed on the multimedia screen accompanied by, depending on the type of malfunction, the following message on the instrument panel:

- « Parking sensors unavailable » ;
- or
- « Check Parking sensors » ;
- or
- « Driving assist unavailable » ;
- or
- « Check Driving assist ».

Clean the ultrasonic sensors. If there is still a problem, contact an approved dealer.



If the vehicle is fitted with a towbar recognised by the system and a trailer has been connected, active emergency braking in reverse gear is automatically deactivated and the "Trailer: parking sensors unavailable" message is displayed on the instrument panel,

accompanied by the  warning light **3** on the multimedia screen.

ADDITIONAL DRIVING AID FUNCTIONS

Warnings



Active emergency braking in reverse gear

This function is an additional driving aid. This function cannot, under any circumstances, replace the vigilance and responsibility of the driver.

Some climatic and environmental conditions can disrupt or damage the system. As a consequence, the driver should always be ready for sudden incidents while driving: always ensure that there are no small, narrow moving obstacles (such as a child, animal, pushchair, bicycle, stone, post, etc.) in the blind spot when manoeuvring.

The triggering of this function may be delayed or prevented when the system detects clear signs of control of the vehicle by the driver (action on the steering wheel, pedals etc.).

System servicing/repairs

- In the event of an impact, the rear sensors and their performances may be affected. Deactivate the function and consult an authorised dealer.
- Any work in the area where the sensors are located (repairs, replacements, bumper modifications etc.) must be carried out by a qualified professional.

Only an authorised dealer is qualified to service the system.

Deactivating the function

You must deactivate the function if the vehicle is being towed (breakdown recovery) or if the vehicle is fitted with a towbar that is not recognised by the system.

In the event of the system behaving abnormally, deactivate it and consult an authorised dealer.

SPEED LIMITER

The speed limiter function controls the engine and braking system to help you not to exceed a driving speed that you have chosen, known as the **limit speed**.

The speed limiter function can be activated from 0 to 93 mph (150 km/h) or, depending on the vehicle, to 105 mph (170 km/h).



While ECO mode is activated, the limit speed cannot exceed the maximum speed for ECO mode → 183.

Controls

Control A

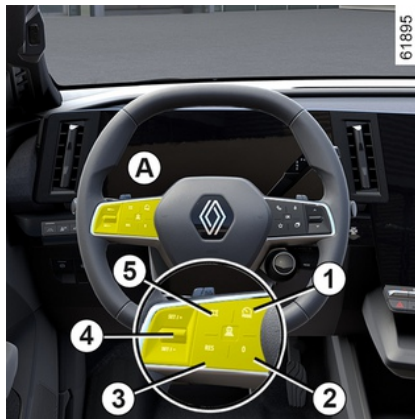

1. Switch for selecting/deselecting the driving aids, depending on the vehicle:

- Active Driver Assist;
- Adaptive Cruise Control;
- speed limiter;
- OFF.

2. Puts the function on standby and stores the limited speed (0).

3. Recalling the stored limit speed (RES).

4.

– Upwards: activates, increases limited speed or stores the current speed (SET/+).

– Downwards: activates, decreases limited speed or stores the current speed (SET/-).

5. Pop-up button (depending on the vehicle): adapt the speed setpoint to

detected speed limits  → 229.



Depending on the vehicle, you can link the speed limiter function to the "Road sign detection" function → 229 by pressing the switch 5.

If the "OFF" mode is selected before switching off the engine, the "Speed limiter" function will be activated by default the next time the engine is started.

Driving

When a limit speed has been set but not yet reached, driving is similar to driving a vehicle without the speed limiter function.

Once you have reached the stored speed, no effort on the accelerator pedal will allow you to exceed the pro-

SPEED LIMITER

grammed speed except in an emergency (refer to information on "Exceeding the limit speed").

Switching on

Control A



Press switch **1** as many times as necessary to select the speed limiter.



The **8** warning light appears in grey. The "Speed limiter ready: SET to activate" message appears on the instrument panel accompanied by dashes to indicate that the speed limiter function is activated and waiting for a limit speed to be stored.

To store the current speed, press the switch **4** upwards (SET/+) or downwards (SET/-): the limited speed replaces the dashes and, depending on the vehicle, the warning light **8** appears in white.

The minimum stored speed is 19 mph (30 km/h).

Varying the limit speed

Control A



You can change the limit speed by repeatedly pressing or pressing and holding on control **4**:

- upwards (SET/+) to increase the speed;
- downwards (SET/-) to decrease the speed.

Automatic speed limiter with speed limit sign recognition

(depending on subscription: without a subscription this function cannot be activated. To manage your subscription, see the multimedia instructions.)

SPEED LIMITER

Using the camera, the "Road sign detection" function → 229 and the map associated with the subscription, the system automatically limits the vehicle speed when a speed limit road sign is identified and passed.

Activation/deactivation

From the multimedia screen, in the "Vehicle" world, select "Driving aids". Then, from the "Speed adaptation" menu view the "Adaptive cruise control" field and select "To speed limits".

Note: you can also activate/deactivate by pressing and holding the contextual button **5**.

Exceeding the limit speed

It is possible to exceed the limit speed at any moment. To do this, press the accelerator pedal **firmly down** (close to or beyond the point of resistance, depending on the vehicle).

While the speed is being exceeded, the speed limiter flashes in yellow/orange on the instrument panel.

Then, release the accelerator pedal: the speed limiter function will return as soon as you reach a speed lower than the memorised speed.



You must keep your feet near the pedals to be ready to react in an emergency.



If the speed limiter is not available (after several attempts to activate), contact an approved dealer.

Putting the function on standby

Control A

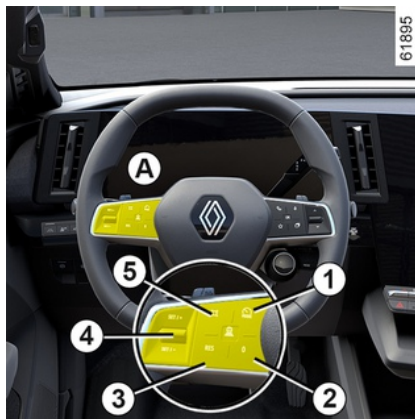

The speed limiter function is suspended when you press switch **2** (0).

The limit speed is stored and displayed in grey on the instrument panel.

Recalling the limit speed

If a speed has been stored, you can recall it by pressing the switch **3**.



When the speed limiter is set to standby, pressing the **4** control upwards or downwards reactivates the function without taking into account the stored speed: it is the speed at which the vehicle is moving that is taken into account.

SPEED LIMITER

Switching off the function

Control A

3



The speed limiter function is interrupted when you press the **1** switch to deselect the limiter. In this case, the speed is no longer stored.

The **8** warning light disappears from the instrument panel to confirm that the function has stopped.

 To exit the driving assistance, press switch **1** as many times as necessary until you reach OFF. The "Driving Assistance deactivated" message appears on the instrument panel. In this case, the next time the engine is started, the "Speed limiter" function will be activated and waiting for a speed limit to be stored.

STOP AND GO ADAPTIVE CRUISE CONTROL

Introduction

Based on information from a radar or camera, the Stop and Go adaptive cruise control function gives you the option of maintaining a selected speed, known as the cruising speed, while keeping a safe distance from the vehicle in front in the same lane.

Depending on the vehicle, when the "Road Sign Detection" function is activated → **229**, the system can adapt the speed of your vehicle according to the speed limit signs recognized by the camera.

Depending on the country and subscription, the system will use the camera and the map to adjust the vehicle speed in advance according to the context and road incidents (roundabouts, bends, upcoming road signs or speed limit zones).

If the vehicle in front stops, the Stop and Go adaptive cruise control may brake your vehicle to a complete stop before setting off again.

The system controls acceleration and deceleration of your vehicle using the engine and braking system.

The system's maximum range is approximately 130 metres. This may vary according to the road conditions

(ground relief, weather conditions, etc.).

The Stop and Go adaptive cruise control function can be activated while the vehicle is travelling at between 0 mph and 93 mph or 105 mph (0 km/h and 150 km/h or 170 km/h) according to road conditions (traffic, weather, etc.).

The function is indicated by the  symbol.

Note:

- the driver must observe the maximum speed limit and safe distances according to the legislation in the country where they are driving;
- the adaptive cruise control can brake the vehicle up to around a third of the braking capacity. Depending on the situation, the driver may need to brake harder.

 While ECO mode is activated, the cruising speed cannot exceed the maximum speed for ECO mode → **183**.

 The regenerative braking system and the paddles are not available when the cruise control or the adaptive cruise control function is activated.

 The Stop and Go adaptive cruise control does not trigger an emergency stop and its braking capability is limited.

STOP AND GO ADAPTIVE CRUISE CONTROL



This function is an additional driving aid.

It can under no circumstances replace the

driver's responsibility to respect speed limits and safe distances or to be vigilant.

The driver must always be in control of the vehicle.

The driver must always adapt their speed according to the surroundings and traffic conditions.

Use the Stop and Go adaptive cruise control function outside built-up areas, on wide roads with visible lines.

The cruise control may have limited operation on very winding or slippery roads (black ice, aquaplaning, gravel) or during bad weather (fog, rain, side winds, etc.)

There is a risk of accidents.

Location of the camera 1

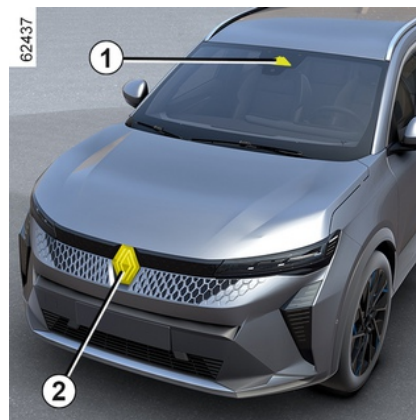

Make sure the windscreen is not obscured (by dirt, mud, snow, etc.).

Location of the radar 2

Ensure that the radar protection plate is not obstructed (dirt, mud, snow, a badly fitted number plate), impacted, modified (including painting) or hidden by any accessory fitted on the front of the vehicle (on the grille or logo, etc.).

Controls



3. Switch for selecting/deselecting the driving aids, depending on the vehicle:

- Active Driver Assist;
- Adaptive Cruise Control;
- speed limiter;
- OFF.

4. Put the function on standby (with cruising speed stored) (0).

5 Recall the stored cruising speed (RES).

6

- Upwards: activates, increases cruising speed or stores the current speed (SET/+).

STOP AND GO ADAPTIVE CRUISE CONTROL

– Downwards: activates, decreases cruising speed or stores the current speed (SET/-).

7 Pop-up button (depending on the vehicle): adapts the speed setpoint to detected speed limits

 → **229**

8 Adjusting the following distance.

 Depending on the vehicle, you can link the cruise control function to the "Road sign detection" function → **229** by pressing the switch **7**.

If the "OFF" mode is selected before switching off the engine, the "Speed limiter" function will be activated by default the next time the engine is started.



The radar and camera zones must be kept clean and free of any tampering in order to ensure the proper operation of the system.

Displays

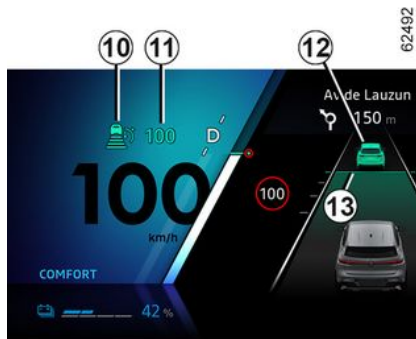

10. Stop and Go adaptive cruise control warning light.

11. Stored cruising speed.

12. Vehicle in front.

13. Stored safe distance



Important: you should keep your feet near the pedals at all times to prepare for any event.

Switching on

Control A



Press switch **3** as many times as necessary to select adaptive cruise control. The **10** warning light appears in grey. The "Adaptive Cruise Control ready: SET to activate" message appears on the instrument panel accompanied by dashes to indicate that the cruise control function is in operation and waiting to store a cruising speed.

This function cannot be activated when:

- the parking brake is applied;
- the driver's seat belt is not fastened;
- one or more doors are incorrectly closed;

STOP AND GO ADAPTIVE CRUISE CONTROL

– the "Hands-free parking" function is already activated.

The "Adaptive Cruise Ctl unavailable" message is displayed on the instrument panel.

3 Activating cruise control

While the vehicle is stationary or moving at a steady speed, push the control **6** upwards (SET/+) or downwards (SET/-): the function is activated and the current speed is stored.

The minimum cruising speed is 19 mph (30 km/h).

The cruising speed **11** replaces the dashes and cruise control is confirmed by the appearance of the cruising speed in green and warning light **10**.

If you try to activate the function above 96 mph (155 km/h) or, depending on the vehicle, 109 mph (175 km/h), the "Invalid Speed" message is displayed and the function remains inactive.

Once a cruising speed is memorised and the cruise control function is active, you may lift your foot off the accelerator pedal.

Note: if your vehicle speed is lower than about 19 mph (30 km/h), the function uses a default cruising speed of 19 mph (30 km/h). The vehicle will accelerate until it reaches the stored cruising speed.

Activating cruise control with speed limit sign recognition (display C)



(depending on the vehicle)

If the vehicle is equipped with the "Road Sign Detection" → **229** function, press the contextual button **7** to adapt the vehicle's speed to the **15** speed limits detected by the camera.

When passing the sign, the cruising speed **11** adopts the value of the detected speed **15**.

Activating cruise control with advance speed limit sign recognition (display D)



(depending on subscription)

Using the camera, the "Road sign detection" function → **229** and the map associated with the subscription, the system anticipates the automatic adjustment of the vehicle speed until the next sign is identified **16**.

Activation/deactivation

From the multimedia screen, in the "Vehicle" World, select "Driving assistance". Then, from the "Comfort" menu, select "Speed limit adaptive cruise control".

STOP AND GO ADAPTIVE CRUISE CONTROL

The letter "A" **17** is displayed on the instrument panel to confirm the activation of the cruise control with advance speed limit sign recognition.



Note:

- you can also activate/deactivate the function by pressing and holding the pop-up button **7**;
- in some cases (if there is a significant difference between the vehicle speed and limited speed), the system may request that you validate the speed manually by pressing the pop-up button **7**: the white square **18** is displayed around the indicated speed to inform you.



Cruise control with advance speed limit sign recognition is associated with a subscription. If there is no subscription, this function cannot be activated.

To manage the subscription, please refer to the multimedia instructions.

Operation

With the function activated, the following speeds are displayed on the instrument panel:

- cruising speed **11**;
- the current speed limit detected by the system on the section of road on which the vehicle is travelling **15**;
- the speed detected by the system on the next road section or speed limit zone **16**.

The detected speed **16** is taken into account by the system. The vehicle speed adjusts gradually, until it becomes the cruising speed **11**, without any action from the driver. The speed indicated on **16** is displayed on **15** when passing the sign or zone identified.

The driver must always stay vigilant regarding the speed applied by the

system and remains responsible for the vehicle speed.

When the function is not activated or the subscription is no longer active, the operation is identical to setting the cruising speed with speed limit sign recognition (display **C**).

Activating cruise control with advance recognition of the road layout (display **E)**



(depending on subscription)

Using the camera, the "Road sign detection" → **229** function, and the mapping purchased with the subscription, the system can anticipate and manage the automatic adaptation of the cruis-

STOP AND GO ADAPTIVE CRUISE CONTROL

ing speed **10**, when the vehicle approaches a roundabout or a bend.

If the vehicle is approaching a bend or roundabout, a **19** warning light appears on the instrument panel. The vehicle adjusts its speed to a speed appropriate to the feature detected.

The driver must always stay vigilant regarding the speed applied by the system and remains responsible for the vehicle speed.

Activation/deactivation

From the multimedia screen, in the "Vehicle" World, select "Driving assistance". Then, from the "Comfort" menu, select "Road layout adaptive cruise control".

In the "Adaptive regulation" menu, select "To road context".

(When the function is not activated or the subscription is no longer active, operation is the same as setting the cruising speed with speed limit sign recognition (display **A** or, depending on the subscription, setting the cruising speed with speed limit sign recognition (display **D**).

The following symbols show the features taken into account by the system:

-  roundabout;

-  bend.



Cruise control with advance recognition of the road layout is associated with a

subscription.

If there is no subscription, this function cannot be activated.

To manage the subscription, please refer to the multimedia instructions.

Controlling cruising speed

You can resume control of the vehicle speed at any time by:

- putting the function on standby:
 - by pressing the brake pedal;
 - or by pressing the switch **4** (0);
- by pressing the driving aids selection/deselection switch **3**.

When automatically adapting the speed to the signs and/or road layout, it is possible to ignore these events. Press the control **5** upwards (RES/+) to recall the stored cruising speed.

Safe distance control activation

As soon as cruise control is activated, the default safe distance **13** is dis-

played in green on the instrument panel.

If the system detects a vehicle in your lane, an outline of a vehicle **12** appears above the distance gauge **13** on the instrument panel.

Your vehicle adapts its speed to that of the vehicle in front and applies the brakes if necessary (the brake lights come on) in order to maintain the distance displayed on the instrument panel.

Note: the size of the **12** outline varies according to the distance separating you from the vehicle in front. The larger the outline, the closer the vehicle in front.

Setting the cruising speed

Control **A**

You can vary the speed by pressing repeatedly (for low variation) or pressing and holding (for high variation) the control **6**:

- downwards: (SET/-) to reduce the speed;
- upwards (SET/+) to increase the speed.

STOP AND GO ADAPTIVE CRUISE CONTROL

Adjusting the following distance

You can vary the safe distance from the vehicle in front at any time by pressing switch **8** repeatedly.



The horizontal distance gauge on the instrument panel indicates the various available safe distances:

- distance gauge **F**: long distance (corresponding to approximately 2.4 seconds);
- distance gauge **G**: intermediate distance 2 (corresponding to approximately 2 seconds);
- distance gauge **H**: intermediate distance 1 (corresponding to approximately 1.6 seconds);

- distance gauge **I**: short distance (corresponding to approximately 1.2 seconds).

The selected distance gauge appears in green on the instrument panel. The other gauges remain in grey.

Note: the distance must be set according to the traffic level, local regulation and weather conditions.



The safe distance is adjusted by default on the distance gauge **G**.

Exceeding the cruising speed

The cruising speed may be exceeded at any time by applying the accelerator pedal.

If it is exceeded, the cruising speed **11** appears in yellow.

If the driver presses the accelerator pedal, the "Distance Control" function will no longer operate.

Then, release the accelerator pedal: the cruise control and safe distance control will automatically resume the speed and distance instructions that you had previously selected.

Overtaking manoeuvre

If you want to overtake the vehicle in front and your speed is over 43 mph (70 km/h) only, activating the direction indicators temporarily reduces the following distance and triggers acceleration to facilitate overtaking.

Stopping the vehicle and setting off

If the vehicle in front slows down, the system adapts its speed to bring the vehicle to a complete stop if necessary (e.g. in heavy traffic). The vehicle stops a few metres from the vehicle in front.

When the vehicle in front sets off again:

- if the stop lasts for less than thirty seconds, the vehicle will start again without any action required from the driver.

Note: the driver should always be ready for sudden incidents while driving and remains responsible for controlling the vehicle: if the system detects a pedestrian in the area around the vehicle, the automatic restart will be inhibited until the next stop;

- if the stopping time exceeds approximately thirty seconds, for the vehicle to set off again it is necessary to either:

STOP AND GO ADAPTIVE CRUISE CONTROL

- by pressing the accelerator pedal;
- by pressing once on the button **5** (RES) on control **A**.

The message "Press RES or accelerate to restart Cruise Control" appears on the instrument panel to confirm.

If the stop exceeds around three minutes, the electronic parking brake is automatically applied and the Stop and Go adaptive cruise control is deactivated.

The indicator light **10** goes out to confirm that the function is deactivated.

Putting the function on standby

You can set the function to standby when:

- you press switch **4** (0) ;
- you apply the brake pedal while the vehicle is moving.

The function is deactivated by the system if:

- you put the gear control in position P, R or N ;
- you unbuckle the driver's seat belt;
- you open one of the opening elements;
- you press the engine start/stop button;
- the slope is too steep;

– certain driving aids and correction devices are triggered (active emergency braking, ABS, ESC, etc.)

Note: Depending on the vehicle, if the reception of the connected data is not optimal, the system automatically switches on standby the advance speed limit sign recognition and/or advance recognition of the road layout functions.

The two functions are automatically reactivated as soon as reception of the connected data becomes optimal again.

In all circumstances, the standby is confirmed when the warning lights appear in grey and the message "Adaptive Cruise Control disconnected" appears on the instrument panel.



Putting the Stop and Go adaptive cruise control in standby or switching it off does not cause a rapid reduction in speed: you must brake by applying the brake pedal if necessary.

Exit from standby

Based on the stored cruising speed

If a speed is stored, it can be recalled, once you are sure that the road conditions are suitable (traffic, road surface, weather conditions, etc.). Press the **6**, switch upwards in the range of valid speeds.

When the stored speed is recalled, activation of the cruise control is confirmed by the illumination of the cruising speed in green.

Note: if the stored speed is higher than the current speed, the vehicle will accelerate to reach that speed.

Based on the current speed

When the cruise control is set to standby, pressing switch **6**, downwards reactivates the cruise control function without taking into account the stored speed: it is the speed at which the vehicle is moving that is taken into account.

STOP AND GO ADAPTIVE CRUISE CONTROL

"Take control of the vehicle" warnings

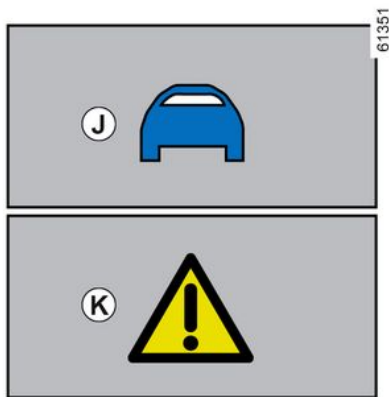

In some situations (e.g. coming up on a much slower vehicle, vehicle in front changing lanes quickly, etc.) the system may not have time to react.

Depending on the situation, the system sounds a beep associated with:

- the orange alert **J** if the situation requires the driver's attention;
- or
- the red alert **K** accompanied by the message "Brake" if the situation requires the driver's immediate attention.

In all situations, react accordingly and perform the appropriate manoeuvres.

Switching off the function



The adaptive cruise control Stop and Go function is interrupted:

- when you press the **A** control switch **3**

The **10** warning light disappears from the instrument panel to confirm that the function has stopped.

 To exit the driving assistance, press switch **3** as many times as necessary until you reach OFF. The "Driving Assistance deactivated" message appears on the instrument panel. In this case, the next time the engine is started, the "Speed limiter" function will be activated and waiting for a speed limit to be stored.

Temporary unavailability (radar)



The radar is able to detect vehicles in front of your vehicle. The system can-

STOP AND GO ADAPTIVE CRUISE CONTROL

not operate correctly if the radar detection area is obscured or if its signal is disrupted.

If the radar detection area is obstructed or the radar signal is disrupted, the message "Front radar no visibility" is displayed on the instrument panel and the adaptive cruise control Stop and Go is interrupted.

The green warning light **10** disappears to confirm that the function has been automatically deactivated.

Ensure that the radar area remains clean and is not obstructed by snow, mud, a badly fitted number plate or by any accessory fitted on the front of the vehicle (on the grille), or hidden by any accessory fitted on the front of the vehicle (on the grille or logo, etc.).

Conditions in certain geographical areas may hinder the function, for example:

- arid zones, tunnels, long bridges or lightly used roads without road lines, without signs or trees nearby;
- a military or airport zone.

You must leave such areas in order for the function to work.

In all cases, if the message is not erased after the engine is restarted, please contact an authorised dealer.

Temporary unavailability (camera)

The system cannot operate if the camera is obscured (by dirt, mud, snow, condensation, etc.).

In the event of decreased visibility of the camera, the performance of the adaptive cruise control Stop and Go will be reduced. Remain vigilant.

Operating faults

If an adaptive cruise control function Stop and Go operating fault is detected, the "Check adaptive cruise control" message appears on the instrument panel and the adaptive cruise control Stop and Go function is suspended.

If an operating fault is detected on one or more components of the system, the Stop and Go adaptive cruise control function is deactivated.

Depending on the type of malfunction, the message is displayed on the instrument panel:

- "Check Front camera", accompanied, depending on the vehicle, by the

warning light  ;

- "Front radar to check", accompanied, depending on the vehicle, by the

warning light  ;

- "Check Camera/Radar", accompanied, depending on the vehicle, by the

warning light  ;

- "Check vehicle" accompanied by the

warning light  .

Consult an approved dealer.

Limitations of system operation

Vehicle detection

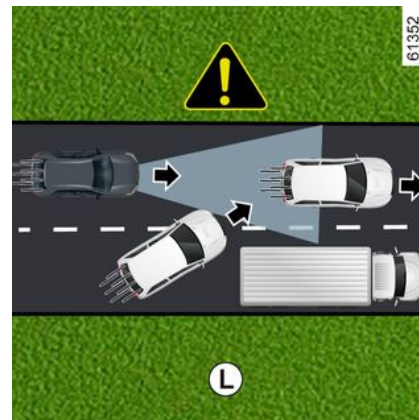

The system detects only vehicles (cars, trucks, motorbikes) that are moving in the same direction as your vehicle.

A vehicle turning into the same lane (e.g. **L**) will be taken into account by

STOP AND GO ADAPTIVE CRUISE CONTROL

the system only once it enters the camera and radar detection areas.

The system may trigger inappropriate or delayed braking.



The system cannot detect:

- vehicles arriving at intersections: slip road (e.g. **M**), etc.;
- vehicles driving on the wrong side of the road or reversing towards you.



The Stop and Go adaptive cruise control must be used outside built-up areas, on wide roads with visible lines.

Detection during cornering



When entering a corner or bend, the radar and/or camera may be temporarily unable to detect the vehicle in front (e.g. **N**).

The system may trigger an acceleration.

When exiting a bend, the system's detection of the vehicle in front may be disrupted or delayed.

The system may trigger inappropriate or delayed braking.

Detection of vehicles in adjacent lanes

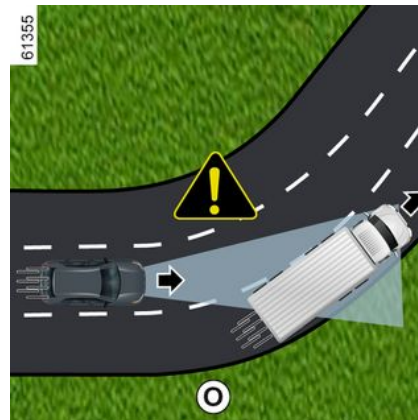

The system may detect vehicles driving on an adjacent lane when:

- you drive into a bend (e.g. **O**);
- you are driving on a road with narrow lanes;
- the speed of the vehicle on the adjacent lane is slower and if one of these vehicles is located too close to the lane of the other.

The system may incorrectly trigger vehicle slowing or braking.

STOP AND GO ADAPTIVE CRUISE CONTROL

3

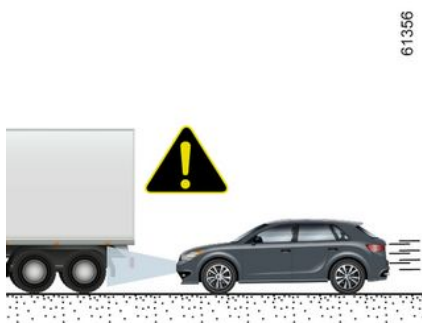

61356

P

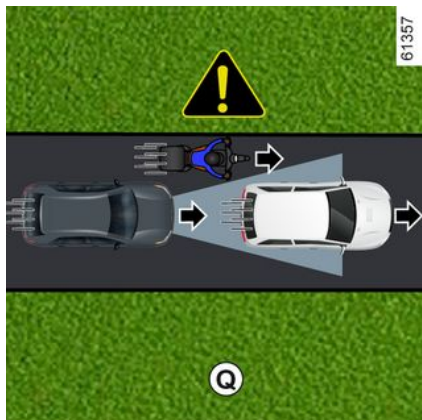

61357

Q

Vehicles hidden due to variations in ground relief

The system will not detect vehicles hidden due to variations in ground relief or those located outside of the camera and radar detection areas when driving uphill or downhill.

Vehicles outside the camera and radar detection areas.

The system will react late or not at all if the detected vehicles are outside the camera and radar detection areas, particularly in the following cases:

- vehicles transporting long objects which exceed the line;
- the actual length of tall vehicles (e.g. **P**) is outside the radar detection area (construction machine, agricultural equipment towing vehicle, etc.);
- vehicles insufficiently centred in the lane;
- narrow vehicles which are very close (e.g. **Q**).

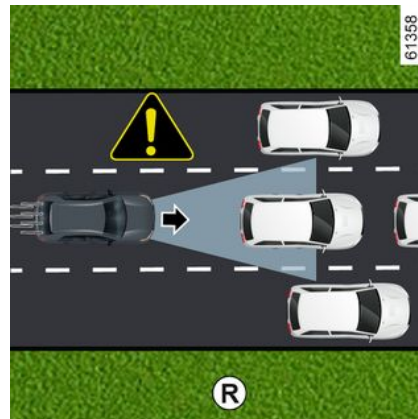

61358

R

Stationary and slow moving vehicles

When your speed is over approximately 31 mph (50 km/h), **the system does not detect:**

- stationary vehicles (e.g. **R**);
- very slow moving vehicles.

When your speed is less than approximately 31 mph (50 km/h), **the system may not react or may react very late** to:

- stationary vehicles (e.g. **R**);
- very slow moving vehicles;

STOP AND GO ADAPTIVE CRUISE CONTROL

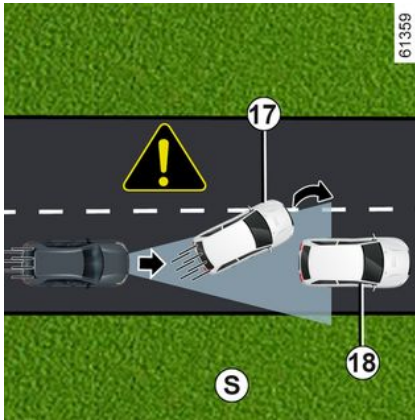

- vehicles in front **17** that change lane, discovering a stationary vehicle **18** (e.g. **S**);
- stationary vehicles **19**, when you change lane (e.g. **T**).

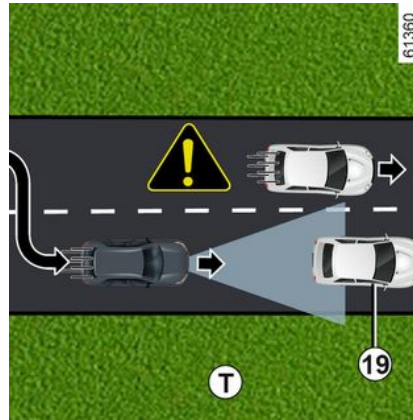

Always be ready to respond in all circumstances.

The driver must always be in control of the vehicle.

The Stop and Go adaptive cruise control does not trigger an emergency stop and its braking capability is limited.

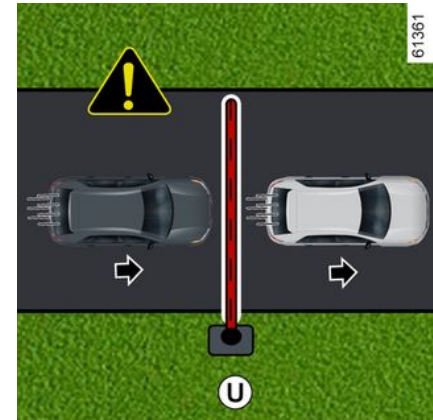

Non-detection of fixed obstacles and objects of a small size

The system cannot detect:

- pedestrians, bikes, scooters, etc.;
- animals;
- fixed obstacles (toll barriers, walls, etc.) (e.g. **U**).

These are not taken into account by the system. They do not trigger any alert or reaction by the system.

STOP AND GO ADAPTIVE CRUISE CONTROL

Detection of vehicles moving into lane at high speed

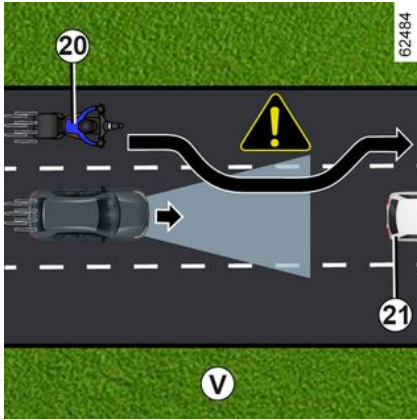

If your vehicle is overtaken by another vehicle driving at high speed **20** (motorcycle, car, etc.) and the vehicle is temporarily between you and the vehicle in front **21**, **the system may trigger undue acceleration, slowing or braking.**

STOP AND GO ADAPTIVE CRUISE CONTROL

Warnings



This function is an additional driving aid. It can under no circumstances replace the driver's responsibility to respect speed limits and safe distances or to be vigilant.

The driver must always be in control of the vehicle.

Apart from the speed limit signs and road map information from the mapping (vehicles fitted with the "Road sign detection" function and a subscription), other traffic information (traffic lights, pedestrian crossings, etc.) is not taken into account by the system. The driver must always adapt their speed to the surroundings and driving conditions, regardless of system indications.

The system should under no circumstances be taken to be an obstacle detector or an anti-collision system.

Use the adaptive cruise control Stop and Go outside built-up areas, on wide roads with visible lines.

System servicing/repairs

- In the event of an impact, the radar and/or camera alignment may be changed and its operation may consequently be affected. Deactivate the system and consult an authorised dealer.
- Any work in the proximity of the radar and/or camera (replacements, repairs, windscreen modifications, paintwork etc.) must be carried out by a qualified professional.

Only an authorised dealer is qualified to service the system.

STOP AND GO ADAPTIVE CRUISE CONTROL



Deactivating the function

You must deactivate the function if:

- the vehicle is being towed (breakdown recovery);
- the vehicle is towing a trailer or a caravan;
- the vehicle is being driven in a tunnel or close to a metallic structure;
- the vehicle arrives at a toll point, a roadwork area or on a narrow lane;
- the vehicle is driven on a very winding road (mountain road, etc.);
- the vehicle is being driven up or down a very steep slope;
- the visibility is poor (glaring sun, fog, etc.);
- the vehicle is being driven on a slippery road surface (rain, snow, gravel, etc.);
- the weather conditions are poor (rain, snow, side winds, etc.);
- the radar area has been damaged (impacts, etc.);
- the camera area has been damaged (e.g. on the inside or outside of the windscreen);
- the windscreen is cracked or distorted.

In the event of the system behaving abnormally, deactivate it and consult an authorised dealer.

STOP AND GO ADAPTIVE CRUISE CONTROL



In the event of system disturbance

Some conditions can disturb or damage the system's operation, such as:

- the windscreen or bumper is obscured in the radar area (by dirt, ice, snow, condensation, number plate, etc.);
- a complex environment (tunnel, etc.);
- poor weather conditions (snow, heavy rain, hail, black ice, etc.);
- poor visibility (night, fog, etc.);
- being dazzled (glaring sun, lights of vehicles travelling in the opposite direction; etc.);
- narrow, winding or undulating road (tight bends, etc.);
- a vehicle with a significant difference in speed;
- use of mats not adapted to the vehicle. On the driver's side, only use mats suitable for the vehicle, attached with the pre-fitted components, and check the fitting regularly. Do not lay one mat on top of another. **There is a risk of wedging the pedals.**

In this case, the system may brake or accelerate unintentionally.

Many unforeseen situations may affect the system operation. Certain objects or vehicles that can appear in the camera or radar detection zone may be interpreted by the system incorrectly, possibly leading to inappropriate acceleration or braking. **You should always be attentive to sudden events that might occur while you are driving. Always keep your vehicle under control by keeping your feet near the pedals, so that you are ready to act in any event.**

PARKING AIDS

Parking distance control

Operating principle

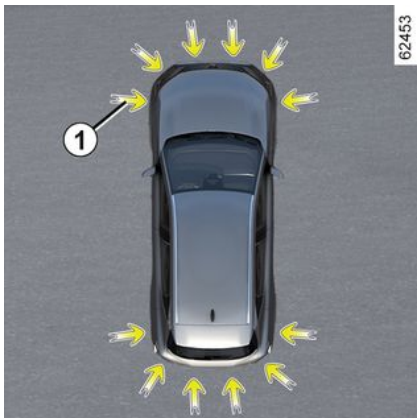

Ultrasonic sensors, indicated by arrows **1**, are fitted in the bumpers to detect obstacles near the vehicle.

The function alerts the driver via audible signals and a display representing the area where the obstacle was detected.

Depending on the equipment, the system detects obstacles behind, in front and to the sides of the vehicle.

The Park Assist system is only activated when the vehicle is driven at a speed below approximately 6 mph (10 km/h).

The function does not take into account towing or carrying systems that are not recognised by the system.



This function is an additional driving aid. Under no circumstances should it replace the driver's care or responsibility whilst reversing.

The driver should always be ready for sudden incidents while driving: always ensure that there are no small, narrow moving obstacles (such as a child, animal, pushchair, bicycle, stone, post, etc.) in the blind spot when manoeuvring.



An impact to the underside of the vehicle while manoeuvring (e.g. striking a post, raised kerb or other street furniture) may result in damage to the vehicle (e.g. deformation of an axle). To avoid any risk of accident, have your vehicle checked by an approved dealer.

Location of the ultrasonic sensors **1**

Ensure that the area around the ultrasonic sensors indicated by the arrows **1** is not obscured (by dirt, mud, snow, a badly fitted/attached number plate), impacted, modified (including paintwork) or obstructed by any accessory fitted to the rear and/or, depending on the vehicle, to the front or sides of your vehicle.

Note: on vehicles equipped with the "360° Camera" → **286** function, the analysis of the vehicle surroundings (zones **A** and **B**) is not displayed in the "Bird's eye view" or "Side view".

PARKING AIDS

Operation

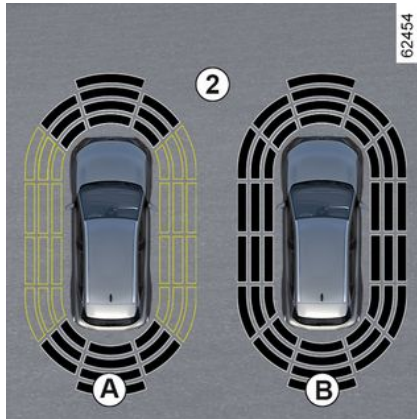

The display **2** shows the vehicle surroundings and emits beeps.

Depending on the equipment, it may be necessary to travel a few metres before the side detection is activated.

If all areas have a grey background, the whole area around the vehicle is being monitored:

- Display **A**: analysis of vehicle surroundings in progress;
- Display **B**: analysis of vehicle surroundings complete.

Obstacle detection

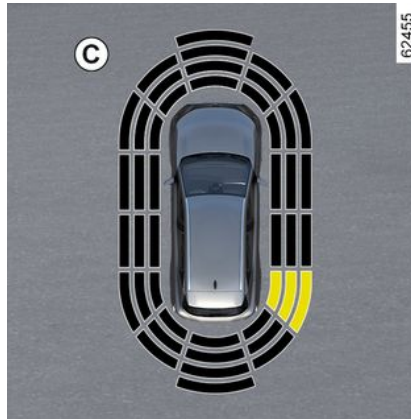

Most objects located less near the front, rear and sides of the vehicle are detected.

The audible signal frequency will increase as the vehicle approaches an obstacle, until it becomes a solid beep at approximately 20 cm for an obstacle detected on the sides and approximately 30 cm for an obstacle detected to the front or rear.

The area where the obstacle has been detected is displayed (display **C**). Depending on the vehicle, the area is displayed in green, orange (or yellow depending on the vehicle) or red, depending on the proximity of the detected obstacle.

 In the event of a change in trajectory during a manoeuvre, the risk of collision with an obstacle may be signalled late.

Special case of obstacles detected on the side

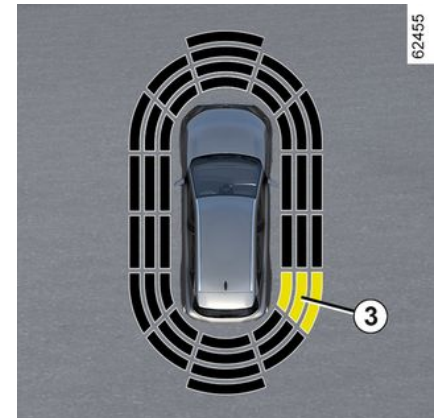

Depending on the direction of the wheels, the system determines the trajectory of the vehicle and notifies the driver if there is a risk or not of a collision with an obstacle **3** to the side of the vehicle.

If a side obstacle is detected:

- the beeps become faster and then sound continuously as the obstacle

PARKING AIDS

gets nearer. The area where the obstacle **3** has been detected is displayed (display **D**).

– if there is no risk of collision, no beep will sound when approaching the obstacle. Depending on the vehicle, the area where the obstacle **3** has been detected is shown interspersed.



In the event of a change in trajectory during a manoeuvre, the risk of collision with an obstacle may be signalled late.

Activation/deactivation

Activation/deactivation from the multimedia screen **4**

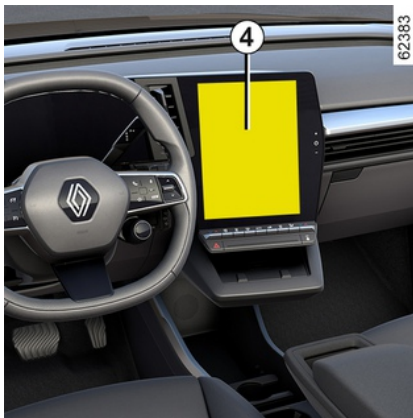

From the "Vehicle" world on your multimedia screen **4**, press the "Parking assistance" menu.

Activate or deactivate areas covered by the ultrasonic detectors.

Please refer to the multimedia instructions for further information.

Note: depending on the vehicle, the rear detection zone cannot be deactivated.

Parking distance control automatic deactivation

The system is deactivated:

- when the vehicle speed is above approximately 6 mph (10 km/h);
- depending on the vehicle, when the vehicle is stationary for more than ap-

proximately five seconds and an obstacle is detected (such as when in a traffic jam, etc.);

- when you are in N or P position;
- when an operating fault is detected.

Note: depending on the vehicle, if the vehicle is fitted with a towbar recognised by the system, only the rear Park Assist function is deactivated.

Settings



For safety reasons, carry out any adjustments while the vehicle is stationary.



Each time the vehicle is started, the function resumes the activation status saved the last time the engine was stopped.

Adjusting settings from the multimedia screen **4**

PARKING AIDS

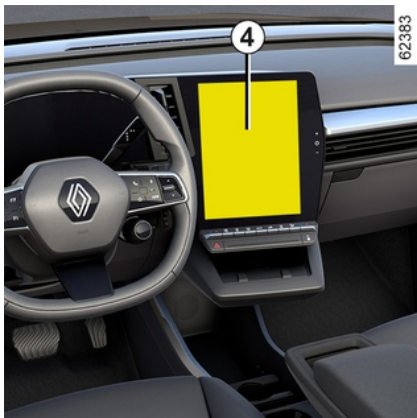

With the vehicle stationary, from the "Vehicle" world on the your multimedia screen **4**, press the "Parking assistance" menu.

Please refer to the multimedia instructions for further information.

Deactivating the system sound (depending on the vehicle)

Activate or deactivate the parking distance control sound.

Note: if you mute the sound, when approaching an obstacle you will be alerted only by the display.

Parking distance control audio volume

Adjust the Park Assist volume using the volume bar.

 Each time the vehicle is started, the function resumes the activation status saved the last time the engine was stopped.

Special cases

You can manually deactivate sound alerts or, depending on the vehicle, the detection zone concerned in the event that:

- towing, carrying or trailer equipment that is unrecognised by the system is present in front of the ultrasonic sensors;
- the ultrasonic sensors are damaged.

Note: even if the sound is muted, the displays will continue to warn you.

Operating faults

When the system detects a malfunction: either a sound signal warns you for about three seconds when the reverse gear is engaged, accompanied by the "Check Parking sensors" message on the instrument panel, or the system does not produce a sound or display when the reverse gear is engaged.

Check that the ultrasonic sensors are clean.

If the fault persists, consult an approved dealer.

PARKING AIDS

Advice



When the vehicle is travelling at a speed below approximately 6 mph (10 km/h), some noises (motorcycle, lorry, pneumatic drill, etc.) may trigger the Park Assist system audible warnings.



System servicing/repairs

- In the event of an impact, the alignment of the sensors may be altered and their operation may consequently be affected. Deactivate the function and consult an authorised dealer.
- Any work in the area where the sensors are located (repairs, replacements, etc.) must be carried out by a qualified professional.

Only an authorised dealer is qualified to service the system.

System disturbance

Some conditions can disrupt or damage the system operation, for example:

- poor weather conditions (rain, snow, hail, black ice, etc.);
- some types of noise (motorcycle, lorry, pneumatic drill, etc.);
- fitting an non-compatible towing ball or hook.

Risk of false alarms or absence of warnings

If the system behaves abnormally contact an authorised dealer.

PARKING AIDS



Limitation of the system operation

- The area around the sensors must be kept clean and free of any modifications in order to ensure the proper operation of the system.
- Small objects moving close to the vehicle (motorcycles, bicycles, pedestrians, etc.) may not be recognised by the system.
- The system may not detect obstacles that are too close to the vehicle.
- The system may not provide a warning when the other vehicles or obstacles are travelling at a significantly different speed.
- During a change in trajectory during a manoeuvre, the system may report obstacles with a delay.
- When the vehicle is towing a trailer, the rear Park Assist system must be deactivated.

PARKING AIDS

Reversing camera

Operation

3



When reverse gear is engaged, the camera **1** located at the rear of the vehicle transmits a view of the area behind the vehicle to the multimedia display **2** accompanied by three guide lines **3**, **4** or **5** (fixed, moving and trailer guide lines).

This system uses several guidelines for its operation (mobile for trajectory and fixed for distance). When the red zone is reached, use the bumper image to stop accurately.



Fixed guide lines **3**

The fixed gauge includes coloured markers **A**, **B** and **C** indicating the distance behind the vehicle:

- **A** (red) at approximately 30 centimetres from the vehicle;
- **B** (yellow) at approximately 70 centimetres from the vehicle;
- **C** (green) at approximately 150 centimetres from the vehicle.

This gauge remains fixed and indicates the vehicle trajectory if the wheels are in line with the vehicle.

Moving guide lines **4**

This is shown in blue on the multimedia screen **2**. It indicates the vehicle trajectory according to the position of the steering wheel.

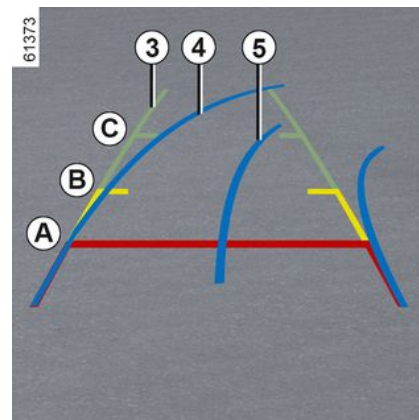

Trailer guide lines **5**

This is shown in blue on the multimedia screen **2**. This indicates the trajectory of the trailer towbar according to the steering wheel position. It allows the driver to position the towbar as close as possible to the trailer's towing head.

« Trailer view »

If a trailer is connected, while in a forward gear press the "Camera" menu in the "Vehicle" world on your multimedia screen **2** to enable the camera **1** to transmit a view of the rear environment during approximately 30 seconds.

PARKING AIDS

Settings



From the multimedia screen **2**, when reverse gear is engaged, press the "Settings" button to add or remove guide lines and to adjust the camera image settings (brightness, contrast, etc.).

Please refer to the multimedia instructions for further information.



Make sure that the camera is not obscured (by dirt, mud, snow, condensation etc.).

"Zoom auto" function

If an obstacle is detected behind the vehicle, the function "Zoom auto" switches the current display to a top rear view.

To activate/deactivate the "Zoom auto" function, refer to the multimedia instructions.



The screen shows a reverse mirror image.

The frames are a representation projected on a flat surface. This information is to not be taken into account when superimposed on a vertical object or an object on the ground.

Objects which appear on the edge of the screen may be deformed.

In very bright light (snow, vehicle in sunshine, etc.), the camera vision may be adversely affected.

If the luggage compartment is open or incorrectly closed, the "WARNING: Boot Open" message appears.

Operating faults

When reverse gear is engaged, if the system detects an operating fault, a

black screen is displayed temporarily on the multimedia screen **2**.

This may be caused by a fault affecting the camera or screen (clearness, fixed image, delayed communication etc.).

If the temporary display of the black screen persists, please consult an approved dealer.



This function is an additional aid. It cannot, therefore, under any circumstances replace the vigilance or the responsibility of the driver.

The driver should always be ready for sudden incidents while driving: always ensure that there are no small, narrow moving obstacles (such as a child, animal, pushchair, bicycle, stone, post, etc.) in the blind spot when manoeuvring.

PARKING AIDS

Difference between the estimated distance and actual distance

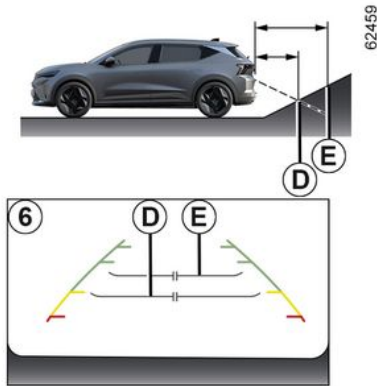

Reversing towards a steep uphill slope

The fixed guidelines **6** show the distances as closer than they actually are.

The objects shown on the screen are actually further away on the slope.

For example, if the screen displays an object at **D**, the actual distance of the object is at **E**.

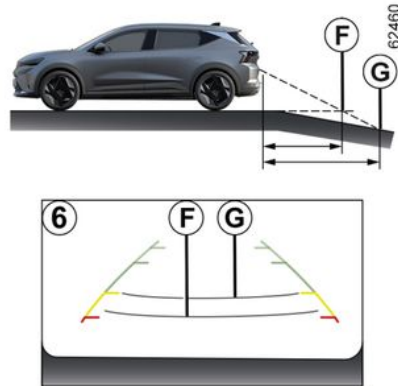

Reversing towards a protruding object

The fixed guidelines **6** show the distances as further than they actually are.

Therefore, the objects shown on the screen are actually closer on the slope.

For example, if the screen displays an object at **G**, the actual distance of the object is at **F**.

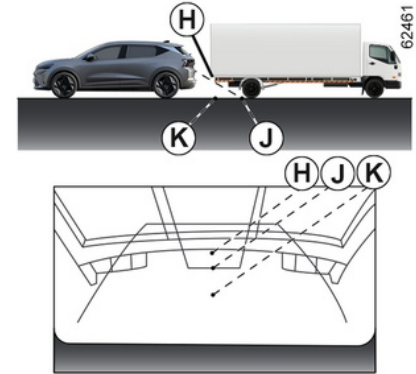

Reversing towards a protruding object

Position **H** seems further than position **J** on the screen. However, position **H** is at the same distance as position **K**.

The trajectory indicated by the fixed and mobile guidelines do not take into account the height of the object. So there is a risk that the vehicle may collide with the object when reversing towards position **K**.

PARKING AIDS

Hands-free parking

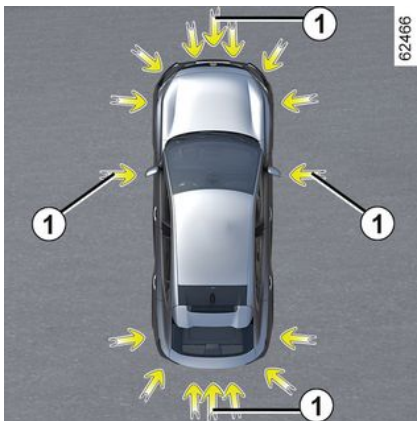

As indicated by the arrows **1**, the ultrasonic detectors installed in the vehicle bumpers help to find accessible parking spaces and assist the parking manoeuvre.

Remove your hands from the steering wheel, you only control:

- the accelerator pedal;
- the brake pedal;
- the gear lever.

At any time, you can regain control by using the steering wheel.



This function is an additional driving aid.

Under no circumstances should it replace the driver's care or responsibility whilst reversing.

The driver should always be ready for sudden incidents while driving: always ensure that there are no small, narrow moving obstacles (such as a child, animal, pushchair, bicycle, stone, post, etc.) in the blind spot when manoeuvring.



An impact to the underside of the vehicle while manoeuvring (e.g. striking a post, raised kerb or other street furniture) may result in damage to the vehicle (e.g. deformation of an axle).

To avoid any risk of accident, have your vehicle checked by an approved Dealer.

Location of the ultrasonic sensors **1**

Ensure that the area around the ultrasonic sensors indicated by the arrows **1** is not obscured (by dirt, mud, snow, a badly fitted/attached number plate, etc.), impacted, modified (including paintwork) or obstructed by any accessory fitted to the rear and, depending on the vehicle, to the front or sides of your vehicle.

Switching on

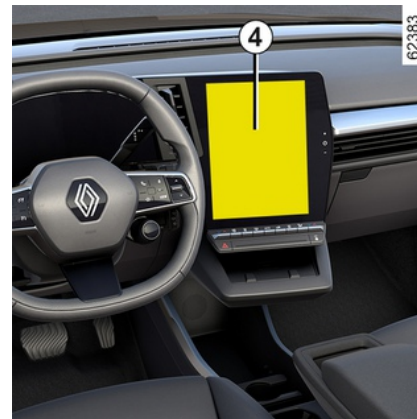

PARKING AIDS

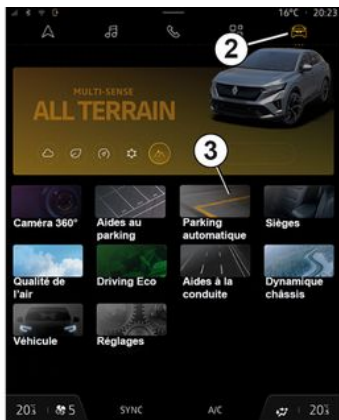

With the vehicle stationary or driving at less than approximately 19 mph (30 km/h), there are several ways to access the function:

- via the multimedia screen **4**, from the "Vehicle" world **2**, press the "Hands-free Park Assist" menu **3** to access the parking aids menu;
- via the "Hands-free Park Assist" widget (if previously configured);
- via the "Favourites" button on the steering wheel (if previously configured);
- depending on the vehicle, via the "Hands-free Park Assist" shortcut in the 360° camera view.

Please refer to the multimedia instructions for further information.

Choice of manoeuvre

The system can perform three types of manoeuvre:

- parking the vehicle in a parallel or perpendicular parking space;
- moving out of a parallel parking space.

From the multimedia screen **4**, select the manoeuvre to carry out.

Note: when starting the vehicle, or after having successfully completed parallel parking using the system, the default manoeuvre proposed by the system is assistance in exiting a parallel parking space.

In other cases, the default manoeuvre can be set from the multimedia screen **4**.

Please refer to the multimedia instructions for further information.



The system start up is accompanied by activation of the parking distance control and, on those vehicles equipped, the reversing camera or 360° camera to help the driver visualise the manoeuvre → **272**, → **278**, → **286**.

Operation



This function is an additional driving aid.

Therefore, it can under no circumstances replace the driver's vigilance and responsibility during manoeuvres (the driver must always be ready to brake).



When manoeuvring, the steering wheel may turn quickly: do not put your hands inside and make sure that nothing is caught inside.

Parking the vehicle in a parallel or perpendicular parking space

As long as the vehicle speed is less than 19 mph (30 km/h), the system looks for available parking spaces on both sides of the vehicle.

Once a space has been found, it is displayed on the multimedia screen **4**, indicated by the letter "P". Drive slowly until the "STOP" message appears, accompanied by a beep. If several spaces are detected on either side of

PARKING AIDS

the vehicle, you must select the desired space by activating the direction indicator. If the spaces are on the same side of the vehicle, only the last space detected by the system will be taken into account.

The space turns to grey on the multimedia screen **4** and is marked by the letter "P".

- Stop the vehicle;
- select reverse gear.

The indicator light  lights up on the instrument panel and a beep sounds.

- Let go of the steering wheel;
- follow the system instructions on the multimedia screen **4**.

Your speed should not exceed around 4 mph (7 km/h).

Once the warning light  on the instrument panel goes off and a beep sounds, the manoeuvre has been completed.

Moving out of a parallel parking space.

- Activate the "Hands-free Park Assist" function;
- select the "Exit parallel parking space" mode;

- activate the direction indicator lights on the side on which you wish to exit the vehicle;

If all conditions are met, a message will appear on the multimedia screen **4** to start the manoeuvre.

- press "OK" to start.

The indicator light  lights up on the instrument panel and a beep sounds.

- Let go of the steering wheel;
- carry out forward and backward manoeuvres following the instructions shown on the multimedia screen **4** and using the alerts provided by the Park Assist system.

Your speed should not exceed around 4 mph (7 km/h).

Once the vehicle is in a position to exit the parking space, the warning light

 disappears from the instrument panel accompanied by a beep and a message appears on the multimedia screen **4** to confirm that the manoeuvre is complete.

Suspending/resuming the manoeuvre

The manoeuvre is suspended in the following cases:

- an obstacle in the direction of movement prevents the manoeuvre from being completed;
- a passenger door or the luggage compartment door is opened.

The  warning light disappears from the instrument panel accompanied by a beep to inform you that the manoeuvre has been suspended. The "Park manoeuvre suspended" message and the reason for interrupting the manoeuvre will be displayed on the multimedia screen **4**.

Make sure:

- you have let go of the steering wheel;
- and
- that all doors and the luggage compartment are closed;
- and
- that no obstacles are in the way of the direction of movement;
- and
- that the engine is started.

If the  warning light flashes, this indicates that the system is once again available to resume the manoeuvre.

To resume the manoeuvre, press the "Parking assistance" menu. Warning

PARKING AIDS

light  comes on the instrument panel.

Follow the instructions shown on the multifunction screen 4.

3 Cancellling the manoeuvre

The manoeuvre is cancelled in the following cases:

- you take control of the wheel;
- the vehicle is stationary for too long;
- the parking brake is applied;
- the vehicle speed has exceeded approximately 4 mph (7 km/h);
- the vehicle wheels have skidded;
- the engine start/stop button is pressed;
- via the multimedia screen 4;
- the instructions given on the multimedia screen are not followed;
- the driver's seat belt is unfastened;
- the driver's door is opened;
- you have performed more than ten forwards/backwards movements in one manoeuvre;
- the parking distance control sensors are dirty or obscured.

The  warning light disappears from the instrument panel accompanied by a beep to warn you that the manoeuvre has been aborted. The "Park manoeuvre cancelled" message

and the reason for cancelling the manoeuvre will be displayed on the multimedia screen 4.

Function unavailable

When you select one of the system activation methods, if the operating conditions are not met, the "Hands-free parking unavailable" message is displayed on the instrument panel to warn you that the function is unavailable.

Operating faults

When the function detects an operating fault, the following messages are displayed on the instrument panel:

- "Check Park Assist", accompanied

by the  warning light;

or

- « Check Parking sensors » ;

or

- « Check Parking assist ».

Clean the ultrasonic sensors. If there is still a problem, contact an approved dealer.

Note: if there is a fault with the function, the vehicle is not immobilised.

Take control of the vehicle again immediately.

PARKING AIDS

Warnings



This function is an additional driving aid. This function is not under any circumstances intended to replace the due care and attention of the driver, who should at all times be in control of the vehicle. Make sure that the manoeuvre complies with the applicable traffic regulations in your location.

The driver should always be ready for sudden incidents while driving: always ensure that there are no small, narrow moving obstacles (such as a child, animal, pushchair, bicycle, stone, post, towing equipment, etc.) in the blind spot when manoeuvring.

System servicing/repairs

- In the event of an impact, the operation of the sensors may be affected. Deactivate the function and consult an authorised dealer.
- Any work in the area where the sensors are located (repairs, replacements, exterior trim modifications, etc.) must be carried out by a qualified professional.

Only an authorised dealer is qualified to service the system.

In the event of system disturbance

Certain conditions may disrupt or impair operation of the system, such as poor weather conditions (snow, hail, ice, etc.).

In the event of the system behaving abnormally, deactivate it and consult an authorised dealer.

Risk of erroneous false alarms.

Limitations of the system operation

- The system cannot detect objects located in the sensor blind spots.
- Always look to check that the parking space suggested by the system is actually still available and free from obstacles before and during the entire manoeuvre.
- The system must not be used when towing a trailer or when there is a towing or load carrying system on the vehicle or on surrounding vehicles.

PARKING AIDS

360° camera

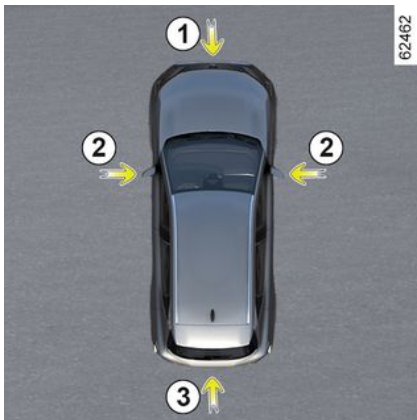

Using information from cameras **1**, **2** and **3** located in the front bumper, door mirrors and on the tailgate, as well as ultrasonic detectors **4** located in the vehicle bumpers, the feature assists with difficult manoeuvres (e.g. parking) by displaying the vehicle surroundings.

Note: make sure that the cameras are not obscured (by dirt, mud, snow, condensation, etc.).

Operation

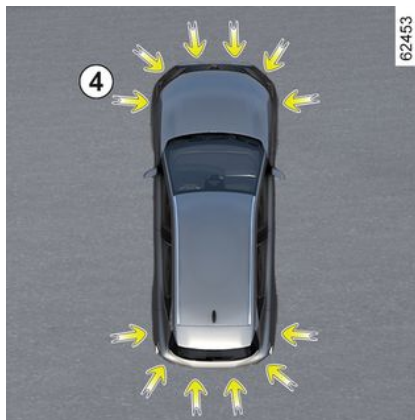

The cameras transmit several separate views to the multimedia screen **5**.

They enable you to view the vehicle surroundings:

- front view (using camera **1**): standard front view and panoramic front view;
- rear view (using camera **3**): standard rear view and panoramic front view;



- bird's eye view (using cameras **1**, **2** and **3**): standard bird's eye view and pop-up bird's eye view (when an obstacle is detected);
- side view (using camera **2**): front side view and rear side view;
- 3D view;
- trailer view.

The ultrasonic detectors detect obstacles at the front, rear and (depending on the vehicle) side of the vehicle.

PARKING AIDS

Front camera 1



The front camera view is displayed on the multimedia screen **5**.



This function is an additional aid. It cannot, therefore, under any circumstances replace the vigilance or the responsibility of the driver.

The driver should always be ready for sudden incidents while driving: always ensure that there are no small, narrow moving obstacles (such as a child, animal, pushchair, bicycle, stone, post, etc.) in the blind spot when manoeuvring.

Rear camera 3



The rear camera view is displayed on the multimedia screen **5**.

3

PARKING AIDS

i For the rear views, the multimedia screen **5** shows a reverse image of the rear view as in a rear view mirror.



In front view or rear view: when manoeuvring on a slope, objects shown on the multimedia screen may be closer or further away than they seem.

Take this into account in order to correctly assess the distance before any manoeuvre.

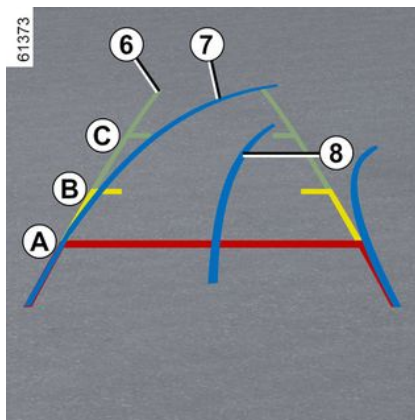

The "front" or "rear" view transmitted to the multimedia screen **5** is displayed with one, two or three guide lines **6**, **7** and **8**.

This system is initially used with the aid of several gauges (mobile and trailer for trajectory and fixed for distance).

Fixed guide lines **6**

The fixed gauge includes coloured markers **A**, **B** and **C** indicating the distance behind the vehicle:

- **A** (red) at approximately 30 centimetres from the vehicle;
- **B** (yellow) at approximately 70 centimetres from the vehicle;
- **C** (green) at approximately 150 centimetres from the vehicle.

Moving guide line **7**

This is shown in blue on the multimedia screen **5**. It indicates the vehicle trajectory according to the position of the steering wheel in the front and the rear view.

Trailer guide line **8**

This is shown in blue on the multimedia screen **5**. This indicates the trajectory of the trailer towbar according to the steering wheel position.

It allows the driver to position the towbar as close as possible to the trailer's towing head.

i The front, rear and side view guidelines are a representation projected onto flat ground; this information must not be taken into account when superimposed on a vertical object or an object on the ground. Objects displayed on the edge of the multimedia screen may appear distorted. In very bright light (snow, vehicle in sunshine, etc.), the camera vision may be adversely affected.

PARKING AIDS



In the combined representation from the cameras:

- raised objects (pavement, vehicle, etc.) may appear distorted in the bird's eye view;
- any objects on top of the vehicle are not displayed.

Driver's side front side camera 2

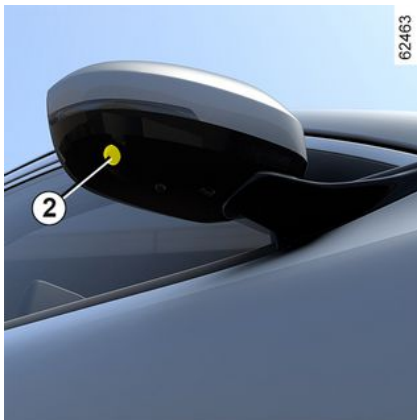

Camera **2**, fitted in the door mirror, transmits a side view to the multimedia screen **5**.

Depending on the vehicle, you can use the multimedia screen to change the

bird's eye view to the front side view. Please refer to the multimedia instructions for further information.

Bird's eye view



The bird's eye view is a combined representation from cameras **1**, **2** and **3**. It displays a view of the top of the vehicle and its surroundings.

This can be used to confirm a view of the vehicle position in relation to its immediate surroundings (front, rear and side).



In "bird's eye view" mode, the objects displayed on the multimedia screen are actually further away than they seem.

Take this into account in order to correctly assess the distance before any manoeuvre.

Side views



On the multimedia screen, press the dedicated button **9** for a view combining a bird's eye view and two side views.

PARKING AIDS

Front panoramic view or rear panoramic view

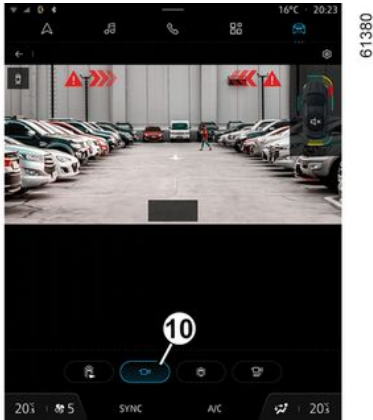

On the multimedia screen, press the dedicated button **10** for a panoramic front view.

When reverse gear is engaged, the front panoramic view is replaced by a rear panoramic view.

Note: the front view or the rear view varies depending on the steering wheel angle, in order to improve the driver's vision.

3D view



On the multimedia screen, by pressing the dedicated button **11**, you get a 3D view allowing you to view the vehicle and its surroundings in three dimensions.

"Trailer view"



In forward gear, if a trailer is connected, press the "360° camera" menu in the "Vehicle" world on your multimedia screen **5** to enable the camera **3** to transmit a view of the surrounding area during approximately 30 seconds.

PARKING AIDS

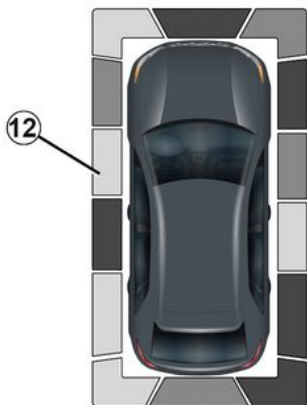

61448

From the multimedia screen, when the "360° camera" system is displayed, you can change the views (e.g. replace the rear view by the panoramic rear view).

Obstacle detection

While the system is activated, if the "Park Assist" function detects one or more obstacles around the vehicle, the indicator **12** is displayed on the various views.

In addition to the audible warning, these indicators show the proximity of obstacles via different colours:

- green: obstacle between approximately 50 and 70 cm;

- yellow: obstacle between approximately 30 and 50 cm;
- red: obstacle within approximately 30 cm.

These indicators also show the locations where obstacles are detected, as indicated by their positions in relation to the "Vehicle" symbol.

For more information → 272.

"Auto zoom" function



62464

If an obstacle is detected in the vicinity of the front or rear of the vehicle, the "Zoom auto" function switches the current display to a specific display (top, front or rear view).

To activate or deactivate the "Zoom auto" function, please refer to the multimedia instructions.

Activation/deactivation



62383

3

Automatic mode

With the vehicle stationary and the engine running, automatic mode is activated when the reverse gear is engaged. The rear view and the bird's eye view appear on the multimedia screen **5**.

When the reverse gear is quickly shifted to forward gear, the rear view and bird's eye view are replaced by the front view and bird's eye view on the multimedia screen **5**.

Automatic mode is deactivated:

PARKING AIDS

- after approximately three seconds, when shifting from reverse gear to the N or P position;
- after approximately three minutes, if the vehicle moves forwards or backwards (e.g. carrying out a manoeuvre) before shifting the lever to position N or P;
- when the vehicle speed moving forward exceeds 6 mph (10 km/h).

Manual mode

To activate manual mode, with the vehicle stationary and the engine on, from the "Vehicle" world on your multimedia screen **5**, press the "360° camera" menu and the front view and bird's eye view will appear on the multimedia screen.

Manual mode is deactivated:

- when the vehicle speed moving forward reaches 6 mph (10 km/h);
- when the gear lever has not been used for approximately three minutes.



- Do not use this function while the door mirrors are in folded position.
- Ensure that the luggage compartment door is properly closed before using the function.
- Do not place any objects on or in front of the cameras.

Difference between the estimated distance and actual distance

Driving or reversing towards a steep uphill slope

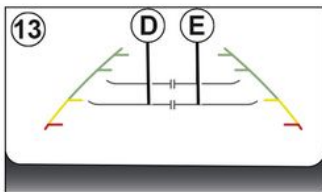

The fixed guidelines **13** show the distances as closer than they actually are.

The objects shown on the screen are actually further away on the slope.

For example, if the screen displays an object at **D**, the actual distance of the object is at **E**.

Driving or reversing towards a steep downhill slope

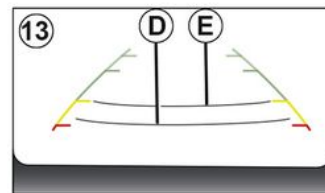
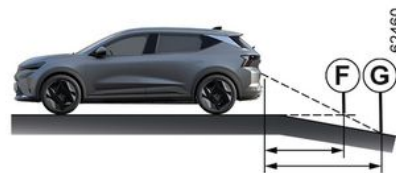

The fixed guidelines **13** show the distances as further than they actually are.

Therefore, the objects shown on the screen are actually closer on the slope.

PARKING AIDS

For example, if the screen displays an object at **G**, the actual distance of the object is at **F**.

Driving or reversing towards a protruding object

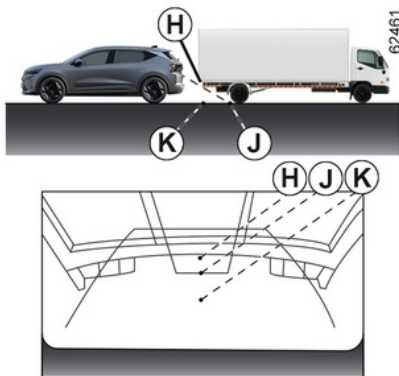

Position **H** seems further than position **J** on the screen. However, position **H** is at the same distance as position **K**. The trajectory indicated by the fixed and mobile guidelines do not take into account the height of the object. So there is a risk that the vehicle may collide with the object when reversing towards position **K**.

Limitation of the system operation

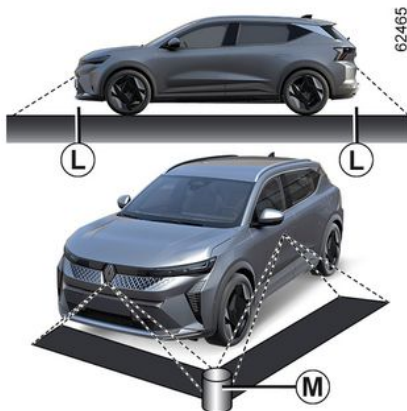

The system is unable to display objects located in certain areas.

In the front or rear view mode, the system cannot be used to view an object in area **L**.

In bird's eye view mode, the system cannot be used to view a large object in area **M** (near the edge of the displayed area).

Adjusting the display



From the multimedia screen, when the "360° camera" system is displayed, you can change the views (e.g. replace the rear view by the panoramic rear view).



For safety reasons, carry out any adjustments while the vehicle is stationary.

If the gear lever is in R position, the following views are available:

– screen split between the rear view/ bird's eye view;

PARKING AIDS

or

– panoramic rear view;

or

– side views/bird's eye view (depending on the vehicle);

or

– 3D view (depending on the vehicle).

When shifting from reverse gear to P position the views available are:

– screen split between the rear view and the bird's eye view;

or

– panoramic rear view (depending on the vehicle);

or

– side views/bird's eye view (depending on the vehicle);

or

– 3D view (depending on the vehicle).

When shifting from reverse gear to D position the views available are:

– screen split between the front view and the bird's eye view;

or

– front panoramic view;

or

– side views/bird's eye view;

or

– 3D view.

Adjusting the camera settings

From the multimedia screen, while the "360° camera" system is displayed, press the "Settings" button to add or remove guide lines and adjust the camera image parameters (brightness, contrast, etc.).

Please refer to the multimedia instructions for further information.

Note: for safety reasons, the views are not displayed on the "Settings" menu while the vehicle is moving.

Parking exit warning

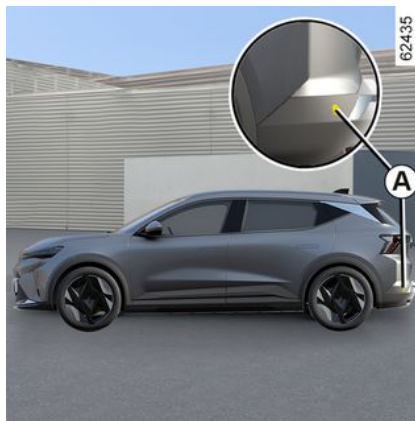

Using information from the radars installed on each side of the rear bumper (zone **A**), the system notifies

the driver when another vehicle appears in the detection zone **B**.

The function is activated if:

– the reverse gear is engaged; and

– the vehicle is stationary or driving at a low speed.

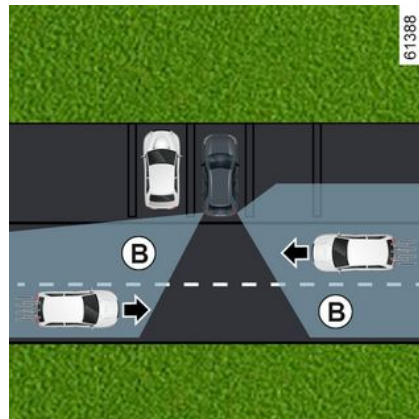

The system's detection capability depends on the vehicle's surroundings (static objects etc.) and the condition of the bumper etc.

PARKING AIDS



This function is an additional driving aid. This function is not under any circumstances intended to replace the due care and attention of the driver, who should at all times be in control of the vehicle.

Special feature



Make sure that the radar area **A** is not obscured (by stickers, mud, snow, etc.).

If a radar is obscured, the "Side radars no visibility" message will appear on

the instrument panel. Clean the area where the sensors are located.

Activation/deactivation from the multimedia screen 1

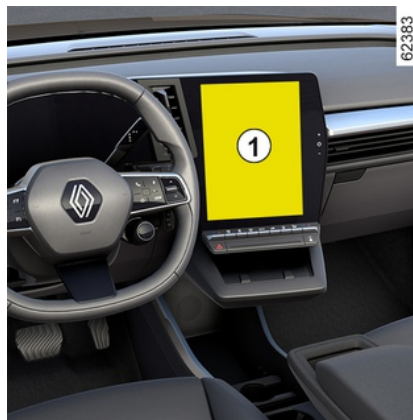

To activate or deactivate the function, refer to the multimedia instructions.

Select "ON" or "OFF".

Operation

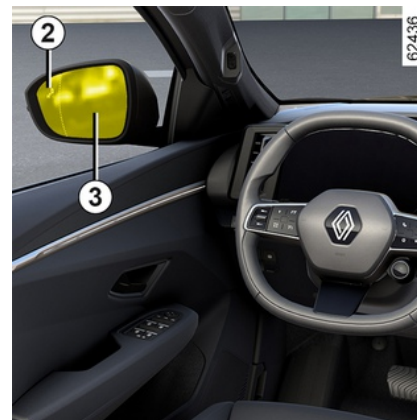

The function warns you if a vehicle is in area **B** and is approaching your vehicle.

When a vehicle is detected, the warning lights **2** light up on both door mirrors **3**.

Note: clean the door mirrors regularly **3** so that the warning lights **2** can be seen.

PARKING AIDS

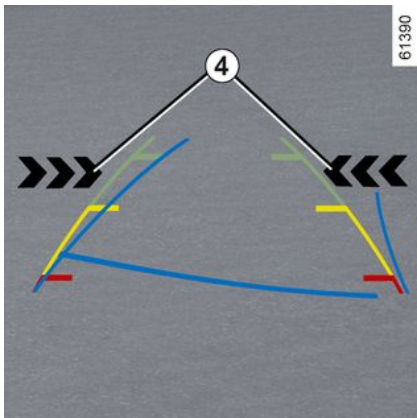

The warning lights **4** on the multimedia screen indicate the side on which the approaching vehicle has been detected.

Note: clean the camera regularly so that it is not obscured.

Warning lights **2** and **4** are accompanied by an audible warning when reverse gear is engaged and your vehicle is moving.

Operating faults

If the vehicle is fitted with a towbar recognised by the system and a trailer has been connected, the parking exit warning is automatically deactivated and the following message is dis-

played on the instrument panel: "Driving assist unavailable".

If the system detects a fault, the "Check Side radars" message is displayed on the instrument panel. Consult an approved dealer.

 Due to the presence of sensors behind the bumper, it is advisable to entrust any operation on the bumper (repair, replacement, paintwork, etc.) to a qualified professional.



Limitation of the system operation

- The radar area should be kept clean and free of any modifications in order to ensure the proper operation of the system.
- Small objects (motorcycles, bicycles, pedestrians etc.) moving towards to the vehicle may not be recognised by the system.

Deactivating the function

You must deactivate the function if:

- the radar area **A** has been damaged (rear bumper);
- the vehicle is fitted with a towbar that is not recognised by the system.

PARKING AIDS



This function is an additional driving aid. This function is not under any circumstances intended

to replace the due care and attention of the driver, who should at all times be in control of the vehicle. The system should under no circumstances be taken to be an obstacle detector or an anti-collision system.

System servicing/repairs

- In the event of an impact, the position of the radars may be changed, affecting the function. Deactivate the function and consult an authorised dealer.
- Any work in the area where the radars are located (repair, replacement, bodywork etc.) must be carried out by a qualified professional.

Only an authorised dealer is qualified to service the system.



System disturbance

Some conditions can disrupt or damage the system operation, for example:

example:

- a complex environment (underground car park, metallic structures, etc.);
- poor weather conditions (snow, heavy rain, hail, black ice etc.).

Deactivating the function

You must deactivate the function if the vehicle is being towed (breakdown recovery) or if the vehicle is fitted with a towbar that is not recognised by the system.

In the event of the system behaving abnormally, deactivate it and consult an authorised dealer.

Safe passenger exit

Description

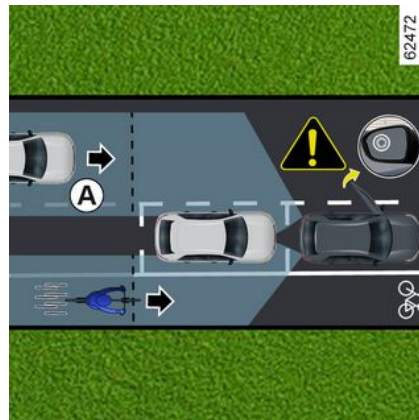

This function is an additional driving aid for the safety of the occupants of the vehicle.

The purpose of the "Safe passenger exit" function is to warn the driver and/or passengers of the potential danger if they open their doors when the vehicle is stationary.

PARKING AIDS

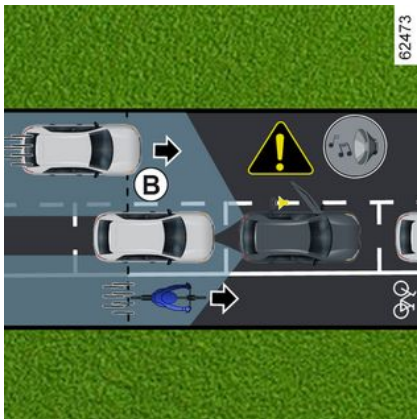

Using information from the sensors installed on each side of the rear bumper (area **C**), the function warns the driver:

- when another vehicle (or motorcycle, bicycle, pedestrian, etc.) is within the detection zone **A**;

and

- when there is a risk of collision with a vehicle (or motorcycle, bicycle, pedestrian, etc.) in the zone **B**.

Special feature

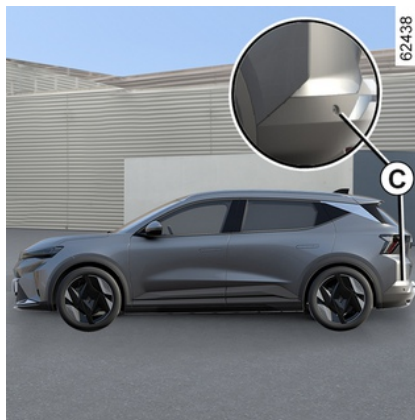

Ensure that zone **C** around the radars on each side of the rear bumper are not obstructed (by dirt, mud, snow, etc.).

If one of the radars is obscured, the "Side radars without visibility" message is displayed on the instrument panel. Clean the area where the sensors are located.

You must deactivate the function if:

- the radar zone **C** has been damaged (rear bumper);
- the vehicle is fitted with a towbar that is not recognised by the system.

Operation

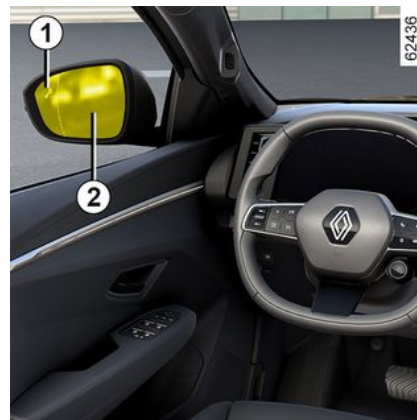

When a door is opened, when a moving object is detected, the warning light **1** is displayed on the door mirror **2** and, depending on the vehicle, the ambient lights in the front door are illuminated.

Note: clean the door mirrors **2** regularly so that the warning light **1** can be seen.

PARKING AIDS



When the detected object is very close, a beep will sound, along with the warning message "Lateral obstacle detected" **3** on the instrument panel.

Note: the system remains active for some time after the ignition has been switched off.

Activating/deactivating the function from the multimedia screen 4

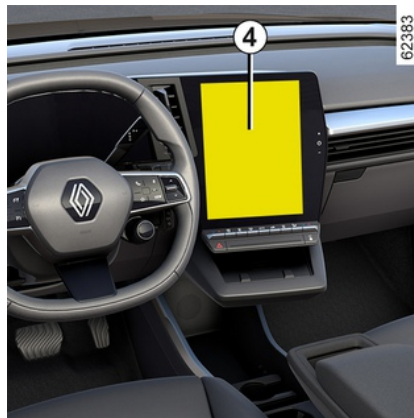

To activate or deactivate the function, refer to the multimedia instructions.



When the vehicle is unlocked, the function returns to the last saved status on the multimedia screen.

Conditions for non-function

- the vehicle is moving and is not completely stationary;
- the vehicle is locked from the outside;

- there are moving objects (motor-bikes, bicycles, pedestrians, vehicles, etc.) moving towards or near your vehicle at a low speed that is not considered a risk by the system;
- the range of the sensors located inside the rear bumper is hidden by objects, such as other particularly wide parked vehicles those parked very close to your vehicle.

If the vehicle is equipped with a towbar recognised by the system, the "Driving aids unavailable" message is displayed on the instrument panel to inform you that the function is not operational.

For information on the range of equipment adapted to your vehicle, we advise you to consult an approved Dealer.

Operating faults

When the system detects a fault, the "Check side radars" message is displayed on the instrument panel. Consult an approved dealer.

PARKING AIDS



This function is an additional driving aid and may not detect certain vehicles or objects in movement in the vicinity of your vehicle. This function is not in any way a substitute for the vigilance and responsibility of the driver and the occupants of the vehicle, who are always responsible for paying particular attention to the traffic situation and checking the area before leaving the vehicle.

In the event of system disturbance

Certain conditions (complex environment, poor weather conditions, etc.) may disrupt or damage the operation of the system, with the risk of false alarms.

EMERGENCY CALL

If the vehicle is equipped, the emergency call function can be used to call the emergency services (without charge) automatically or manually in the event of an accident or illness, reducing the time it takes for the emergency services to arrive.

Note: the emergency call function is operational:

- in countries covered by the telematics services and infrastructure associated and compatible with the system;
- depending on the network coverage in the geographical region where the vehicle is being driven.

If you use the emergency call function to report an accident which you have witnessed, this implies stopping where traffic conditions allow in order for the emergency services to locate your vehicle and therefore the location of the reported accident.

In all cases, comply with local legislation.



Use the emergency call only in the event of an emergency you are involved in, if you witness an accident or if you feel ill.

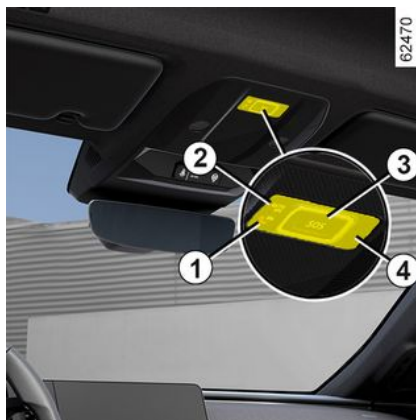

1. System operation warning light:

- green: operational (network available);
- off: non-operational (network unavailable);
- red: operating fault;
- flashing green: call in progress.

2. Automatic mode warning light.

3. "SOS" button.

4. Microphone.

5. Speaker.

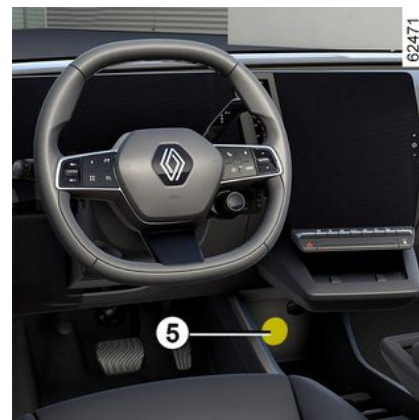

A call always takes place as follows:

- the call is initiated with the emergency services;
- data related to the incident (manufacturer's plate, time of the call, last locations, vehicle direction, etc.) is sent;
- voice communication takes place with the emergency services;
- if necessary, emergency assistance is called.

There are two emergency call modes:

- automatic mode;
- Manual mode.

Automatic mode

If the automatic mode warning light **2** appears in green, this confirms that the automatic system is activated.

EMERGENCY CALL

The emergency call starts automatically in the event of an accident that has required the activation of the protective equipment (seat belt pretensioners, airbag etc.).

3



In the event of an accident, if the location and traffic conditions permit, stay close to the vehicle in order to be able answer the call centre quickly if necessary.

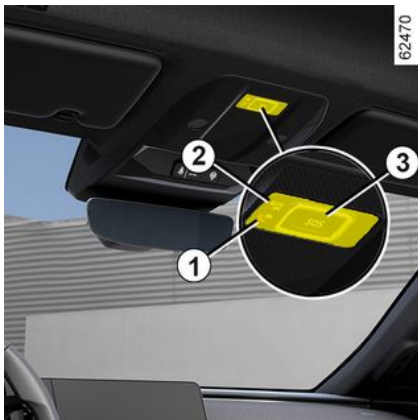

Manual mode

The emergency call can be initiated by:

– pressing and holding the button **3** for at least three seconds;

or

– pressing the button **3** five times within ten seconds.

If the button was pressed by mistake, it is possible to cancel the call by pressing and holding the button **3** for around two seconds, before the call is connected to the call centre.

Once a call is established, only the call centre can end it.

Operating faults

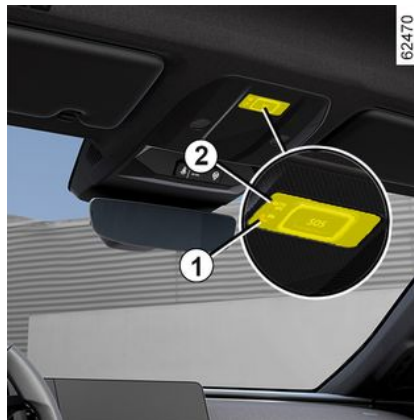

In some cases, the emergency call may not work (e.g. low battery, etc.).

If the system detects an operating fault, the warning light **1** is illuminated in red for more than 30 minutes.

In the event of a system fault, the **1** and **2** warning lights switch off and no longer light up.

In these two cases, contact an approved dealer as soon as possible.



The system operates with a dedicated battery. The battery service life is approximately four years (the warning light **1** appears in red to warn you). Consult an approved dealer.

EMERGENCY CALL



Without the emergency call feature, the system is not trackable and will not be under constant surveillance. Data is automatically and constantly erased, and the system stores only the last three positions of the vehicle.

According to legislation relevant to the country, data is only sent in the event of an emergency call.

Data sent to the call centre is treated according to the personal data protection laws applicable in the country where you are located. The system stores activity history data for 13 hours only.

The vehicle owner has the right of access to their data. They can request that the data be corrected, deleted or locked.



To guarantee your safety and the proper operation of the system, any operation carried out on the battery (removal, disconnection, etc.) must be carried out by a qualified specialist.

Risk of serious burns or electric shocks.

You must respect the replacement intervals (without exceeding them) as stated in the maintenance document.

The battery is a specific type.

Please ensure it is replaced with the same type.

Call an approved dealer.

MULTI-SENSE

Depending on the vehicle, the MULTI-SENSE system enables you to choose from several driving modes that affect the driving, ambient lighting, comfort and driving position:

- all the modes are preconfigured and can be customised (ambient lighting, etc.);
- the "Perso" mode is customisable.

The driving modes influence:

- steering force;
- the Electronic Stability Program;
- engine responsiveness.

They also influence:

- the lighting in the passenger compartment and on the instrument panel;
- the presentation of the instrument panel and the multimedia screen;
- depending on the vehicle, the driving position.

 Engine settings are specific to each of the driving modes and cannot be customised except for the "Perso" mode.

Accessing the menu

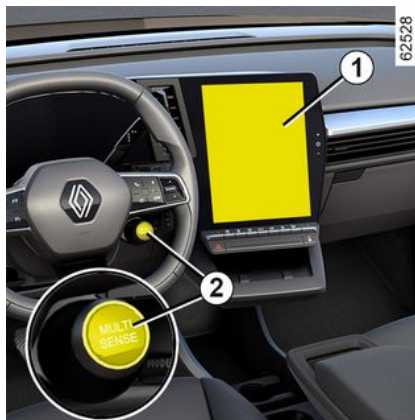

Depending on the vehicle, you can access "MULTI-SENSE":

- from the multimedia screen **1**;
- using the steering wheel control **2**.

Please refer to the multimedia instructions for further information.

 Each time the vehicle is used, the last selected mode will be retained.

"Eco" mode

"Eco" mode focuses on energy saving. The engine and heating level can

be managed to reduce consumption
→ 183.

"Sport" mode

This mode authorises increased engine responsiveness. The steering is firmer.

"Comfort" mode

Using standard vehicle settings, this mode gives you the best compromise between comfort and dynamism.

"Custom" mode

This mode allows the complete configuration of the driving elements, including engine responsiveness.

 You can reset the mode by mode settings.

AIR VENTS, HEATING AND AIR CONDITIONING

Air vents: air outlets

Air outlets

4

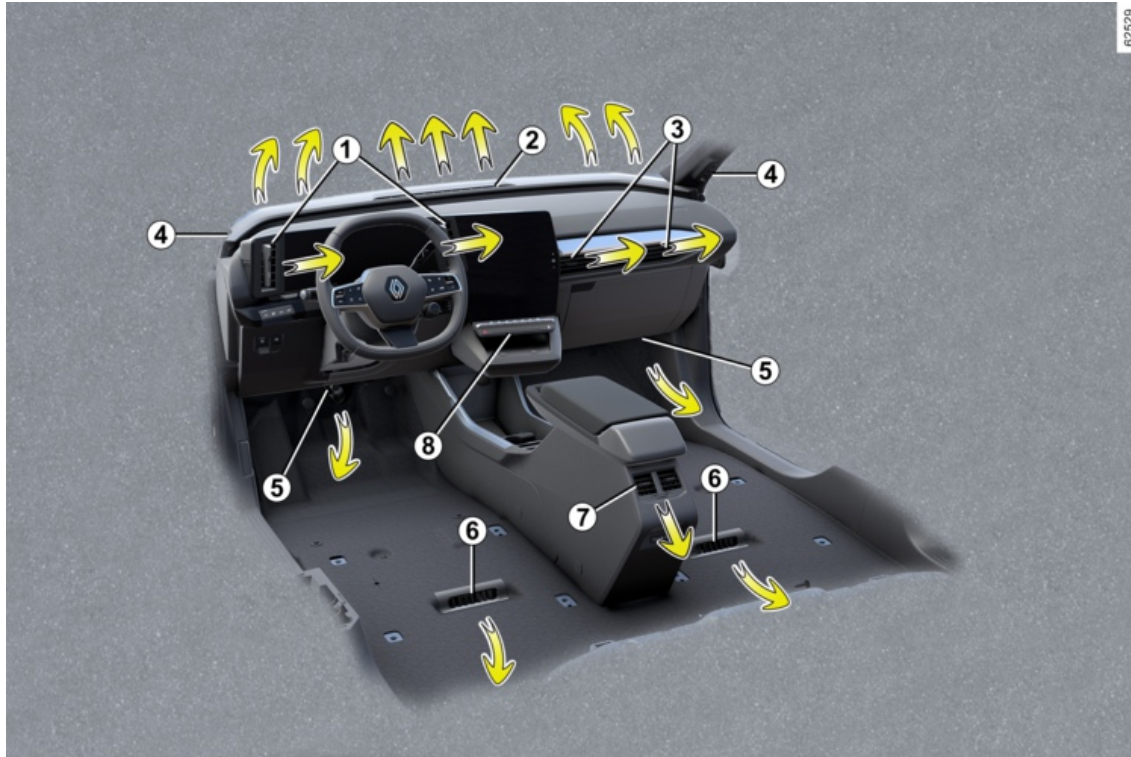

AIR VENTS, HEATING AND AIR CONDITIONING

1. Driver's position air vents
2. Windscreen demister outlet
3. Passenger air vents
4. Side window demister outlet
5. Footwell heater outlets for front passengers
6. Footwell heater outlets for rear passengers
7. Rear passenger central air vents.
8. Control panel

AIR VENTS, HEATING AND AIR CONDITIONING

Driver's position air vents 1



Direction

To direct the air flow, turn the air vents **1** using the tabs **9**.

To close: move the tab **10** away from the steering wheel beyond the point of resistance.

To open: move the tab **10** towards the steering wheel.

Passenger air vents 3

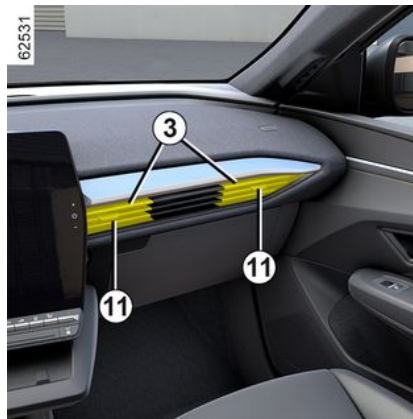

Direction

To direct the air flow, turn the air vents using the tabs **11**.

To close: move the tab **11** towards the outside of the front panel, beyond the point of resistance.

To open: move the tab **11** towards the inside of the front panel.



Do not attach any objects to the air vents (e.g. telephone mounting).

Risk of damage.

Air flow

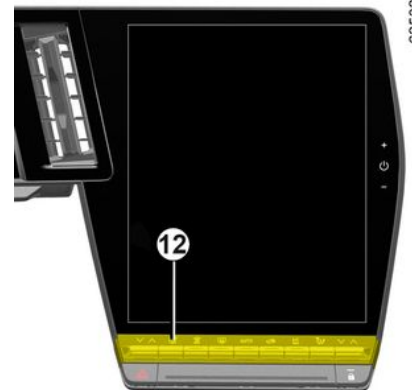

To control the air flow from the air vents **1** and **3**, press or raise the control **12** to the level desired.

To remove bad odours from your vehicles, only use the systems designed for this purpose. Consult an approved dealer.



Do not add anything to the vehicle's ventilation circuit (for example, to remove bad odours).

There is a risk of damage or of fire.

AIR VENTS, HEATING AND AIR CONDITIONING

Rear seats



(depending on the vehicle)

Direction

To direct the air flow, turn the air vents **7** using the tabs.

Air flow

To check the flow of the air vents **7** turn the knob **13** according to the desired opening:

- to the right: maximum air flow;
- to the left: closed.



Do not attach any objects to the air vents (e.g. telephone mounting).

Risk of damage.



Do not add anything to the vehicle's ventilation circuit (for example, to remove bad odours).

There is a risk of damage or of fire.

Automatic climate control

The controls



1. Driver's heating temperature indicator.
2. Ventilation speed indicator.
3. "Synchronisation" SYNC function activation control.
4. Driver's heated seat activation control.
5. Air-conditioning activation control.
6. Passenger's heated seat activation control.
7. Heated steering wheel activation control.

AIR VENTS, HEATING AND AIR CONDITIONING

8. Passenger compartment air distribution indicator.

9. Passenger heating temperature indicator.

10. Adjusting the passenger's air temperature.

11. Passenger compartment air distribution adjustment.

12. Activation control for the "A/C MAX" function.

13. Air recirculation.

14. Air-conditioning activation control in AUTO mode.

15. De-icing/demisting of the rear screen and, depending on the vehicle, the rear view mirrors.

16. "Clear View" function.

17. Adjusting the ventilation speed and stopping the system.

18. Adjusting the driver's air temperature.

Activating the system

When the vehicle is started, the system returns to the last programme used.

The system is also functional when parked.

Press the control **14** to activate the system or set the control **17** to the desired ventilation speed.

Stopping the system

Press the control **17** until it reaches the OFF ».

Switching the air conditioning on or off

In automatic mode, the system manages activation of the air conditioning. You will still be able to activate or deactivate the system by pressing the control **5**.

Automatic mode

The automatic climate control system guarantees comfort in the passenger compartment and good visibility (except in the event of extreme conditions), while optimising fuel consumption.

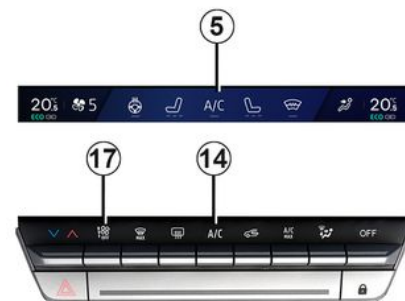

The system controls the ventilation speed, air distribution, air recirculation, and starting and stopping the air conditioning and air temperature.

This mode consists of a choice of three programmes:

AUTO : allows the selected comfort level to be best attained, depending on the exterior conditions. Press the button **14**.

SOFT : reaches the desired comfort level more gently and silently. Press the button **14**, then press downwards to activate SOFT mode.

FAST : increases the air flow in the passenger compartment. This mode is recommended in particular to optimise comfort in the rear seats. Press the

AIR VENTS, HEATING AND AIR CONDITIONING

button **14**, then press upwards to activate FAST mode.

When the air conditioning starts in automatic mode, the system returns to the last programme used.



Any action on a button other than the AUTO button disables automatic mode.

Adjusting the distribution of air in the passenger compartment

Press **11** one or more times to select the air distribution. The air distribution selected **8** is displayed on the multimedia screen. The positions are in the following order:



All the air is then directed to the windscreen and front side window demisting vents.



The air flow is distributed between front side window demisting vents, the windscreen demisting vents and the footwells.



The air flow is distributed between the front side window demisting vents, the windscreen demisting vents, the dashboard air vents and the

footwells.



The air flow is mainly directed to the dashboard air vents.

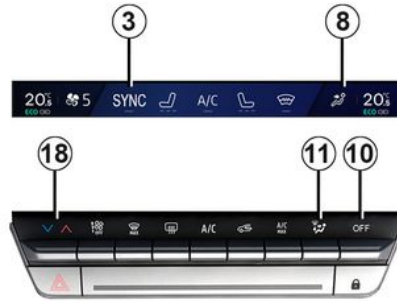

The air flow is directed towards the dashboard vents and towards the footwells.



The air flow is directed mainly towards the footwells.

Adjusting the air temperature

There are two types of settings:

- independent adjustment of the passenger compartment;

- adjusting using the SYNC function to synchronise the passenger side with the driver's side.

Independent adjustment of the passenger compartment

Use controls **10** and **18** to adjust the left-hand and right-hand side independently.

Adjusting using the SYNC

Press SYNC **3** on your multimedia screen to synchronise the passenger side temperature with that on the driver's side.

To exit this function, press again on SYNC or adjust the temperature on the passenger side.

Adjusting the ventilation fan speed

In automatic mode, the system uses the most suitable amount of air to reach and maintain the desired comfort level.

You will still be able to adjust the ventilation speed by pressing the control **17** to increase or reduce the ventilation speed.

"Clear View" function

Press the button **16** and the built-in warning light comes on.

This function quickly de-mists the windscreen, rear screen, front side

AIR VENTS, HEATING AND AIR CONDITIONING

windows and door mirrors (depending on the vehicle). It automatically activates the air conditioning and rear screen de-icing functions.

To exit this function, press button **14** or **16**.



Some buttons have an operating light indicating their operative state.

Rear screen de-icing and demisting



Press the button **15** and the built-in warning light comes on. This function enables rapid demisting or de-icing of

the rear screen and de-icing of the rear view mirrors (on equipped vehicles).

To exit this function, press button **15** again. Demisting automatically stops.

"A/C MAX" function

The "A/C MAX" function enables the user to feel the maximum power of their air conditioning system without any constraint or compromise related to the acoustics and the feeling of the air being too cold on the hands and face.



This function involves automatic modifications:

- temperature programmed to fully cold;
- distribution of air to the occupants;

- air flow at its maximum power;
- activation of the air conditioning;
- air recirculation.

Press the button **12** to activate the function. Deactivate ECO mode to make the most of it.

Air recirculation (isolation of the passenger compartment)

This function is managed automatically, but you can also activate it manually. In this case the operation is confirmed by a warning light built into the button **13**.



Demisting/de-icing will still take priority over the air recirculation.

Manual use

Press the button **13** and the built-in warning light comes on.

Prolonged use of this position may lead to odours, caused by non-renewal of air, and the formation of condensation on the windows.

We therefore advise you to return to automatic mode as soon as air recirculation is no longer needed, by pressing button **13**.

AIR VENTS, HEATING AND AIR CONDITIONING

"Favourites" function



Depending on the vehicle, by pressing the steering wheel control **19** you can activate the following functions according to the stored user settings that you have previously defined:

- heated steering wheel;
- heated seats;
- heated rear screen;
- heated rear view mirrors.

For more information on programming this function, please refer to the multimedia instructions.

ECO mode

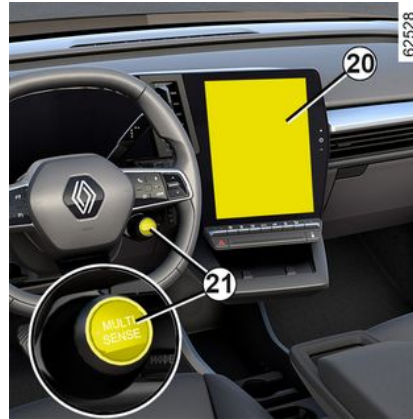

From the MULTI-SENSE menu accessible from the multimedia screen **20** or by pressing the switch **21**, you can activate ECO mode, which affects the heating level and reduces the vehicle's fuel consumption.

An ECO warning light located under the temperature display on the multimedia screen **20** informs you that ECO mode is activated.

Air conditioning: programming

Air conditioning programming



With the vehicle stationary and the engine on, from the "Vehicle" world **2** on the multimedia screen **1**, press the "Electric" menu **3** then the "Charging & Air conditioning" tab to access the settings.

AIR VENTS, HEATING AND AIR CONDITIONING

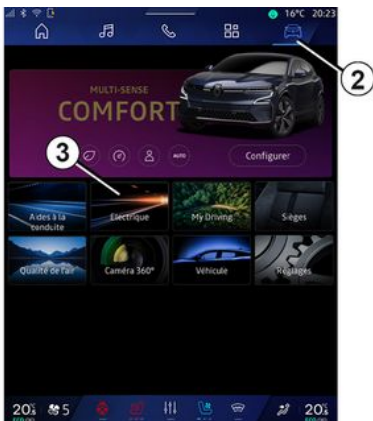

You can save several comfort programmes by activating the following settings:

- temperature adjustment;
- programming the time by which the vehicle must be ready;
- selecting days when the programme must be repeated.

You can activate/deactivate the saved programmes.

Note: you can programme the air conditioning using a smartphone application.

Please refer to the multimedia instructions for further information.



Driver's responsibility when parking or stopping the vehicle

Never leave an animal, child or adult who is not self-sufficient alone in your vehicle, even for a short time.

In hot and/or sunny weather, please remember that the temperature inside the passenger compartment increases very quickly.

RISK OF DEATH OR SERIOUS INJURY.

Activating "Programming"

The function launches before the programmed time so that the vehicle reaches a comfortable temperature by the time the user arrives, if:

- the bonnet is closed;
- the traction battery charge level is over 7.5%;
- the engine is stopped;
- the driver is not in the vehicle.

Warning light  comes on the instrument panel.

Immediate activation of the air-conditioning

It is possible to carry out immediate starting of the air conditioning, if:

- the bonnet is closed;
- the traction battery charge level is over 7.5%;
- the engine is stopped;
- the driver is not in the vehicle.

The operation of the immediate activation of the air-conditioning is different from programming:

- it must be launched from your smartphone;
- the heated steering wheel and seats function, if your vehicle is equipped, is activated automatically;
- the function stops after approximately 10 minutes.

Please refer to the multimedia instructions for further information.

Stopping the programmed air conditioning

The air conditioning stops automatically around ten minutes after the set end time.

However, the function can be deactivated if:

- the engine is running;
- the traction battery charging level is lower than 7%;

AIR VENTS, HEATING AND AIR CONDITIONING

- the bonnet is open;
- you press one of the switches on the control panel;
- the driver is in the passenger compartment for approximately 20 seconds.

Note: these conditions are also applicable for the immediate deactivation of the air conditioning.

If the vehicle is parked for a long time without opening a door with at least one active pre-conditioning schedule, then the function will be deactivated from the third pre-conditioning launch included. The function will be available when one of the doors of the vehicle is opened.

Air conditioning: information and advice on use

Information and advice on use

Advice on use

In some situations (air conditioning off, air recirculation activated, ventilation speed at zero or low etc.), you may notice that condensation starts to form on the windows and windscreen.

If there is condensation, use the "**Clear View**" function to remove it, then use the air conditioning in automatic mode to stop it forming again.



Do not add anything to the vehicle's ventilation circuit (for example, to remove bad odours).

There is a risk of damage or of fire.

Consumption

It is normal to notice an increase in energy usage when the air conditioning is operating.

For vehicles fitted with air conditioning with no automatic mode, switch off the system when it is not required.

Advice for reducing consumption and helping to preserve the environment

Drive with the air vents open and the windows closed. If the vehicle has been parked in the sun, open the doors for a few moments to let the hot air escape before starting the engine.

Maintenance

Refer to the maintenance document for your vehicle for the inspection frequency.



Use the air conditioning system regularly, even in cold weather, running it at least once a month for approximately 5 minutes.

Operating faults

As a general rule, contact your approved dealer in the event of an operating fault.

– Reduction in de-icing, demisting or air conditioning performance.

This may be caused by the cabin filter cartridge becoming clogged.

– No cold air is being produced.

Check that the controls are set correctly and that the fuses are sound. Otherwise, switch off the system.

Presence of water under the vehicle

After prolonged use of the air conditioning system, it is normal for water to be present under the vehicle. This is caused by condensation.

AIR VENTS, HEATING AND AIR CONDITIONING



Do not open the refrigerant circuit. The fluid may damage eyes or skin.

Refrigerant fluid

59952

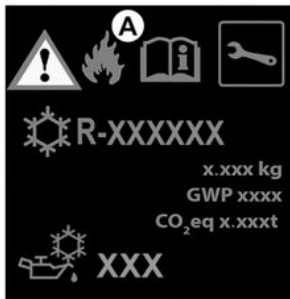

The refrigerant fluid circuit (of which some components are hermetically sealed) may contain fluorinated greenhouse gases.

Depending on the vehicle, you will find the following information on label **A** affixed inside the engine compartment.

The presence and location of the information on label **A** depends on the vehicle.



Type of refrigerant fluid



(XXX) Type of oil in the air conditioning circuit



Inflammable product



Consult the vehicle user manual



Maintenance

x.xxx kg	(1) Quantity of refrigerant fluid present in the vehicle.
GWP xxxxx	(2) Global Warming Potential (CO ₂ equivalent).
CO ₂ eq x.xxxt	(3) Quantity in weight and in CO ₂ equivalent.

Additional information

Depending on label and depending on the type of refrigerant:

Refrigerant fluid R-1234yf

- **(1)** 0.450 kg/1.050 kg
- **(2)** GWP 4
- **(3)** 0.002t/0.004t



Do not open the refrigerant circuit. The fluid may damage eyes or skin.



Before carrying out any action in the engine compartment, you must switch off the ignition

→ 167.

MULTIMEDIA EQUIPMENT



The presence and location of this equipment depends on the vehicle version.

1. Multimedia screen.
2. USB-C multimedia ports in the upper **A** and lower **B** centre console.
3. Steering column control.
4. Voice command.
5. USB-C multimedia ports for the rear passengers.



Please refer to the multimedia instructions for further information.

"USB-C" multimedia ports

The USB-C multimedia ports **2** and **5** can be used to charge accessories with a maximum power of 15 Watts (5 Volts) per port.

Note: the USB-C **2** multimedia ports also allow for data transfer.



MULTIMEDIA EQUIPMENT



Connect accessories with a maximum power of 15 watts only.
Fire hazard.



Using the telephone
We remind you of the need to conform to the legislation in force concerning the use of such equipment.

Microphone 6



(for the phone and voice assistant)

Induction charging zone 7

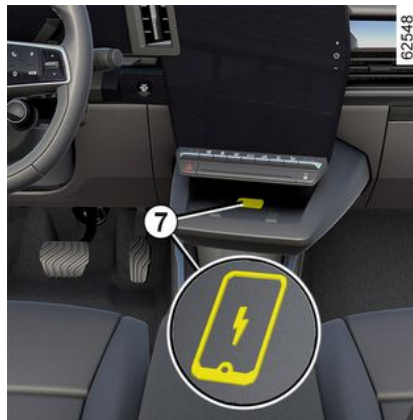

→ 324

PASSENGER COMPARTMENT EQUIPMENT

Electric windows

These systems operate with the ignition on or off, until one of the front doors is opened (limited to about 3 minutes).



Driver's responsibility

Never leave your vehicle with the card or key inside, with a child, adult who is not self-sufficient or a pet in the vehicle, even for a short while.

They may pose a risk to themselves or to others by starting the engine or activating equipment (such as the gear lever or electric windows).

If any part of the body becomes trapped, reverse the direction of the window immediately by pressing the relevant switch.

Risk of serious injury.

One-touch electric windows

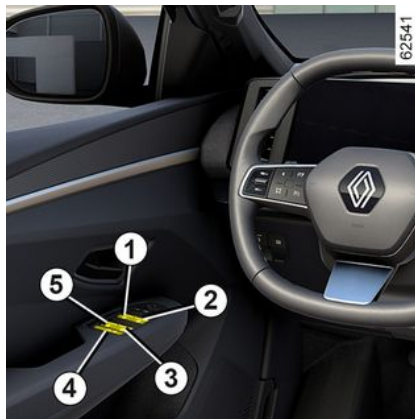

Briefly press or pull a window switch as far as it will go: the window will be fully raised or lowered. Pressing the switch again stops the window moving.

Note: the rear windows do not open fully.

From the driver's seat, use switch:

1. for the driver's side;
2. for the front passenger's side;
3. and 5 for the rear passengers.

From the passenger seats, press the switch 6.

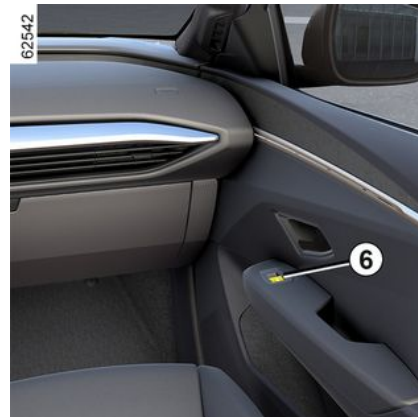

Avoid resting any objects against a half-open window: there is a risk that the electric window could be damaged.



Passenger safety

The driver can deactivate operation of the rear passenger electric windows by pressing switch 4. A confirmation message is displayed on the instrument panel.

PASSENGER COMPARTMENT EQUIPMENT

Note: if the window detects resistance when almost fully closed (e.g. a tree branch), it stops and then lowers again by a few centimetres.

Impossible to operate the one-touch electric window

The one-touch electric window is equipped with heat protection: if you press the switch for the window more than 16 consecutive times it goes into protection mode (locking the window).

You can:

- use the electric window switch briefly and with intervals of approximately 30 seconds;
- with the engine running, the window will be unlocked after approximately 20 minutes of inaction on the electric window switch.

Remote control window opening/closing

When unlocking the doors from the outside, if you **press and hold the card unlocking button**, all the windows equipped with a one-touch electric window will open automatically.

When locking the doors from the outside, if you **press and hold the card locking button**, all the windows equipped with a one-touch electric window will close automatically.

It is recommended that the user only operates the system when the vehicle can be seen clearly and no one is inside.



When closing the windows, ensure that no part of the body (arm, hand, etc.) is protruding from the vehicle.

Risk of serious injury.

Operating faults

In case of a fault when closing a window, the system reverts to normal mode: pull the switch concerned up as often as necessary to fully close the window (the window will close gradually), hold the switch (still on the closure side) for one second then lower and raise the window fully to reinitialise the system.

If necessary, contact an approved Dealer.

Opaque panoramic roof

Operation

The panoramic roof made of opaque glass is divided into two sections (front and rear).

It can become totally opaque or completely transparent. You can also make only one area opaque (front or rear).

Each transition or transition request is accompanied by an animation representing the roof.



To make **the entire roof** opaque or transparent, press and hold switch **1**.

To change **one of the sections (front or rear)** to opaque or transparent mode, press briefly on switch **1** as many as times as required.

Note: before pressing switch **1** again, you must wait for the previously selected action to be completed.

Depending on the vehicle, the operation can also be performed by voice

PASSENGER COMPARTMENT EQUIPMENT

command. For more information, see the multimedia instructions.

i The roof becomes completely opaque after the doors are locked or the vehicle is put into standby mode (doors unlocked and engine off, the instrument panel and/or multimedia screen switch off).

i When the instrument panel and multimedia display are switched on (welcome sequence) or when the engine start/stop button is pressed, the roof returns to the last setting before the vehicle was put into standby mode or when the doors were locked.

Limits of operation

In very cold weather conditions, the panoramic roof may have limited operation (reduced movement) or may not work at all.

Interior lighting

Map reading lights

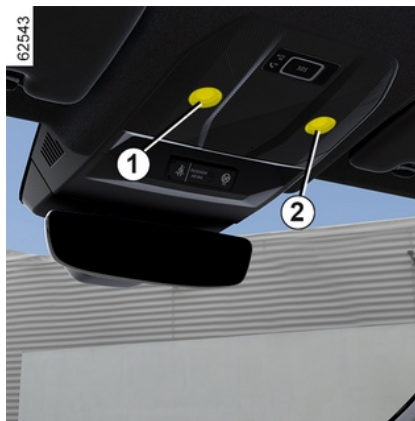

(depending on the vehicle)

Touch the reading lights **1**, **2** or **3** to activate:

- permanent lighting;
- lighting switches off immediately.

Note:

- It is not necessary to press the lights to activate or deactivate the lighting. You only need to make contact;
- you can deactivate/activate the illumination of the reading lights when the doors are opened using the multimedia screen ➔ **136**.



i When the doors are unlocked and opened, the courtesy and footwell lights come on temporarily.

PASSENGER COMPARTMENT EQUIPMENT

Luggage compartment light



The light **4** comes on when the luggage compartment is opened.

Sun visor, mirror

Sun visor

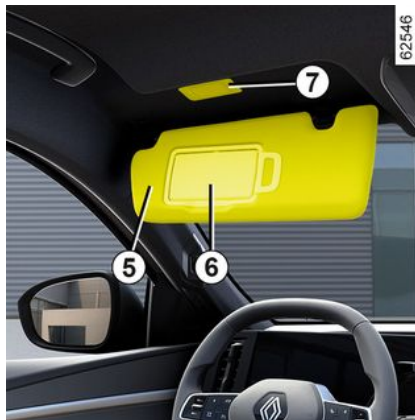

Lower the sun visor **5** over the windscreen or unclip it and flip it over to the side window.

Courtesy mirrors

Lift the cover **6**.

The lighting **7** is automatic.

Accessories socket

Accessories socket 1



It is provided for the purpose of connecting accessories approved by our Technical Department.

It can be used for the compressor of your tyre inflation kit, for example → **347**.

PASSENGER COMPARTMENT EQUIPMENT



Connect accessories with a maximum power of 120 watts (12 V) only.

When several accessory sockets are used at the same time, the total power of the connected accessories must not exceed 180 watts.

Fire hazard.

PASSENGER COMPARTMENT STORAGE, FITTINGS

Front door storage compartment 1



Nothing should be placed on the floor (area in front of the driver) as these objects may slide under the pedals during sudden braking manoeuvres, thus obstructing their use.

Centre console storage compartment or induction charging area 2

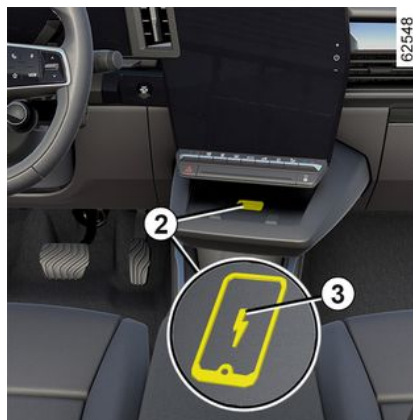

Depending on the vehicle, the 3 symbol indicates that area 2 can be used to charge your phone without using a charging cable.

For more information on the wireless charger, please refer to the multimedia instructions.



Depending on the country and the subscription, the induction charging zone is also the placement zone for smartphones equipped with a digital key → 60.



It is essential not to leave any objects (start-up card, USB memory stick, SD card, credit card, jewellery, keys, coins, etc.) in the induction charging area 2 whilst charging your phone. Remove any magnetic cards or credit cards from the phone case before positioning your telephone in the induction charging area 2.



Objects left in the induction charging area 2 may overheat. You are advised to place them in the areas provided for this purpose (storage compartment, sun visor compartment etc.).

PASSENGER COMPARTMENT STORAGE, FITTINGS

Centre console storage compartment 4

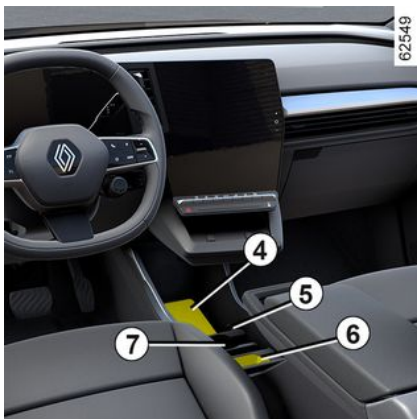

A partition **7** can be used to adjust the centre console storage (various options available depending on the position of the divider in the fitting grooves **5**).

Cup holders 6

Using two partitions **7** you can create an area which can hold another cup. The two separators can be removed to obtain a empty storage space.

Centre armrest storage compartment 9



Depending on the vehicle, lift the cover of the sliding armrest by pushing the button **8**.



Ensure that no hard, heavy or pointed objects are placed in the "open" storage compartments in such a way that they may fall onto passengers during sharp turning, sudden braking or in the event of an accident.



When turning corners, accelerating or braking, ensure that the receptacle being held by the cup holder is not dislodged. **There is a risk of burning if hot liquid escapes.**



Do not drive with the central armrest **9** in the open position as this could hinder the operation of the central airbag and/or lead to injury during inflation.



Do not place any object(s) on the central armrest compartment **9** as this could hinder the operation of the airbag and/or lead to injury during inflation.

PASSENGER COMPARTMENT STORAGE, FITTINGS

Sun blind storage compartment 10



Can be used to hold motorway toll tickets, maps, etc.

Glovebox



To open, press the handle **11**.
It can hold a box of tissues, a bottle of water, etc.

Grab handle 12



This offers support and can be held when the vehicle is moving.
Do not use it for getting into or out of the vehicle.

PASSENGER COMPARTMENT STORAGE, FITTINGS

Rear door storage compartment 13



Storage pocket 14



(depending on the vehicle)

Central rear armrest 16

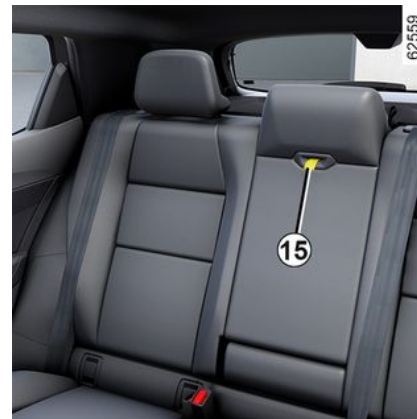

Ensure that no hard, heavy or pointed objects are placed in the "open" storage compartments in such a way that they may fall onto passengers during sharp turning, sudden braking or in the event of an accident.

PASSENGER COMPARTMENT STORAGE, FITTINGS

To access the central armrest **16**, pull the strap **15**.

 Be sure to store the cup holders **17** before closing the armrest.

 When closing the armrest, make sure that no body parts (arms, hands, fingers, etc.) are near the locking area.
Risk of trapping.

Cup holders **17**

 When turning corners, accelerating or braking, ensure that the receptacle being held by the cup holder is not dislodged.
There is a risk of burning if hot liquid escapes.

Storage in the armrest **18**



Lift the cover **19**

 When driving, make sure that the cover **19** is properly closed.
In the event of sudden braking there is a risk of the cover closing by accident.

Tablet holder **20**

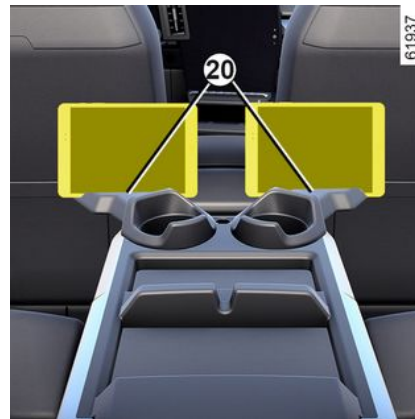

Rotate the cup holders **17** and slide your tablet(s) or smartphone(s) into the housing(s) for storage.

 The housings must only be used to store tablets or smartphones.

PASSENGER COMPARTMENT STORAGE, FITTINGS

Ski rack 22



the strap **21** located behind the central headrest to lower the central seat.

 Before lowering the central seatback, make sure that the central armrest is properly locked in its housing.

 When moving the rear bench seat, ensure that nothing obstructs the anchorage points (body parts, pets, gravel, cloths, toys, etc.).



If you want to carry long objects (skis, etc.) in the luggage compartment, pull

TRANSPORTING OBJECTS

Luggage compartment storage

Transporting objects in the luggage compartment

Always position the objects transported so that the largest surface is against:

4

62568

A



– The back of the rear bench seat, for normal loading (example **A**).

62567

B



– the front seatbacks with the rear seatbacks folded down, as is the case for maximum loads (example **B**).

Ensure that the objects being transported are evenly distributed throughout the loading area.

If you have to place objects on the folded seat back, it is vital that you remove the headrests before folding the seat back so that it can be folded as flat as possible against the seat.



Always position the heaviest items directly on the floor. If the vehicle is equipped, use the lashing points **1** located on the luggage compartment floor. The luggage should be loaded in such a way that no items will be thrown forward and strike the occupants if the driver has to brake suddenly. Fasten the rear seat belts, even if the seats are not occupied.

Towbar



Permissible nose weight, maximum permissible towing weight while braked and unbraked: → 376. Choice and fitting of towing equipment

Towbar (cross member and hitch) not originally fitted to the vehicle: the entire towbar and mountings must not exceed 23 kg.

Any towing device must not obstruct any lighting component or the number plate when not in use. In all cases, you must comply with the regulations of the particular country you are in.

For fitting and conditions of use, refer to the equipment's fitting instructions.

Please keep these instructions with the rest of the vehicle documentation.

TRANSPORTING OBJECTS

63561

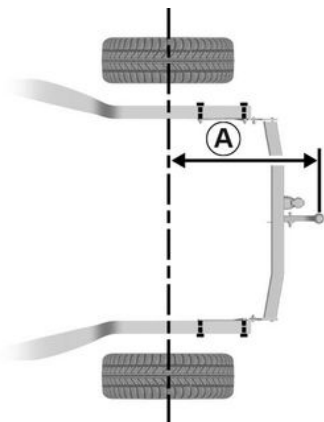

Maximum size **A**: 968 mm.

63562

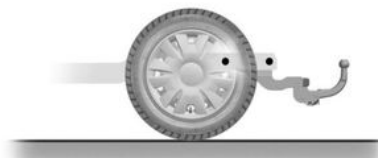

Roof bars

Accessing the mounting points



62570

Open the doors to access the mounting points **1**.



If original roof bars, approved by our Technical Department, are supplied with screws, only use these screws for attaching the roof bars to the vehicle.

User precautions

Handling the tailgate

Before operating the luggage compartment door, check the objects and/or accessories (bicycle rack, roof box, etc.) fitted on the roof bars: these must be correctly positioned and secured, and must not prevent the luggage compartment door from operating correctly.



For information on the range of equipment adapted to your vehicle, we advise you to consult an approved Dealer.

Please refer to the manufacturer's instructions on how to fit and use the bars.

Please keep these instructions with the rest of the vehicle documentation.

Permissible weight on roof bars
➔ **376.**

TRANSPORTING OBJECTS

Spoiler A



4

It is **prohibited** to attach objects and/or accessories (bicycle racks, etc.) to the spoiler **A**.



It is prohibited to attach any carrying equipment (bike rack, luggage box etc.) resting against the spoiler or tailgate. To install a carrying device on your vehicle, contact an Approved Dealer.

ACCESSING THE ENGINE, LEVELS

Bonnet

Unlocking the bonnet catch



To open, pull the handle **1** located on the left-hand side of the dashboard.



Do not do any work under the bonnet when the vehicle is charging or when the ignition is switched on.



Do not press down on the bonnet as there is a risk that the bonnet may accidentally close.



Raise the bonnet by several centimetres and push the lever **2** to the left.



In the event of even a slight impact involving the radiator grille or bonnet, have the bonnet lock checked by an approved Dealer as soon as possible.



The vehicle drive system in an electric vehicle uses a direct voltage of approximately 400 volts.

This system can get hot during and after switching off the ignition. Respect warning messages given on the labels in the vehicle.

Any intervention or modification on the vehicle's 400 V electrical system (components, cables, connectors, traction battery) is strictly prohibited.

The risk of serious burns or electric shocks can lead to death.

The engine cooling fan may also

start at any moment. The  label in the engine compartment reminds you of this.

Risk of injury.

ACCESSING THE ENGINE, LEVELS

Opening the bonnet

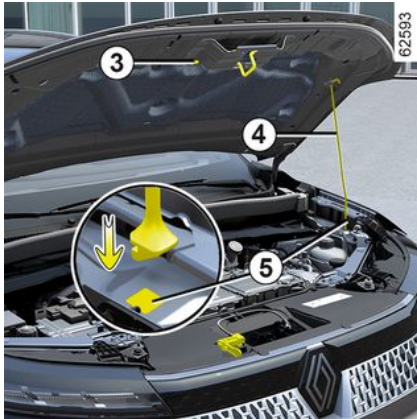

After raising the bonnet and disengaging the strut **4** from its mounting **3**, for your safety you **must** position the strut in its placement **5**.

Closing the bonnet



Before closing the bonnet, make sure that nothing has been left in the engine compartment.

To close the bonnet, re-engage the strut **4** in its mounting **3**. Hold the middle of the bonnet and guide it down to one foot (30 cm) above the closed position, then release. It will latch automatically under its own weight.



When working in the engine compartment, ensure that the windscreen wiper stalk is in the park position.
Risk of injury.



Ensure that the bonnet is properly locked.
Ensure that nothing is preventing locking (grit, cloths, etc.).



After any procedure in the engine compartment, make sure that you do not forget anything (cloth, tools, etc.).
Otherwise, this may lead to engine damage or cause a fire.

ACCESSING THE ENGINE, LEVELS

Coolant level

Coolant level

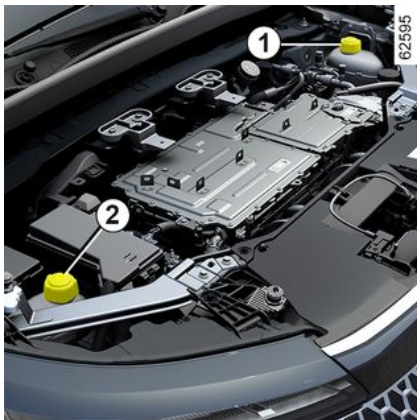

Depending on the vehicle, the location of the coolant reservoirs may vary:

– reservoir **1** is used to cool the engine;

or

– reservoir **1** is used to cool the engine and reservoir **2** is used to cool the traction battery;

or

– reservoir **2** is used to cool the engine and the traction battery.

The level should be read with the engine switched off and on level ground.

For each reservoir, the level **when**

cold must be between the "MINI" and "MAXI" marks on the coolant reservoirs **1** and **2**.

Top this level up **when cold** before the "MINI" mark is reached.

Note: for a new vehicle in the running in phase: the fluid level may be higher than the "MAXI" mark on the reservoir, then drop between the level "MINI" and "MAXI". This does not present a risk.



If there is an abnormal or repeated drop in the fluid level, consult an approved dealer.



No operations should be carried out on the cooling circuit when the engine is hot.

Risk of burns.



The vehicle drive system in an electric vehicle uses a direct voltage of approximately 400 volts.

This system can get hot during and after switching off the ignition. Respect warning messages given on the labels in the vehicle.

Any intervention or modification on the vehicle's 400 V electrical system (components, cables, connectors, traction battery) is strictly prohibited.

The risk of serious burns or electric shocks can lead to death.

The engine cooling fan may also

start at any moment. The  label in the engine compartment reminds you of this.

Risk of injury.

Frequency of checking coolant level

Check the coolant levels regularly (very severe damage is likely to be caused to the engine and battery if there is insufficient coolant).

ACCESSING THE ENGINE, LEVELS

If the level needs to be topped up, only use products approved by our Technical Department which ensure:

- antifreeze protection;
- anti-corrosion protection of the cooling system.

Replacement intervals

Refer to the maintenance document for your vehicle.

5



Do not do any work under the bonnet when the vehicle is charging or when the ignition is switched on.



When working in the engine compartment, ensure that the windscreen wiper stalk is in the park position.
Risk of injury.

Levels, filters

Brake fluid level



The level should be read with the engine switched off and on level ground. This should be checked frequently, and immediately if you notice even the slightest loss in braking efficiency.

Replacement intervals

Refer to the maintenance document for your vehicle.



If there is an abnormal or repeated drop in the fluid level, consult an approved dealer.

Topping up

After any operation on the hydraulic circuit, a specialist must replace the fluid. Only use fluids approved by our Technical Department (and taken from a sealed container).

Level 2

It is normal for the level to drop as the brake shoes become worn, but it must never drop lower than the warning line "MINI".

If you wish to check the disc wear yourself, you should obtain the document explaining the checking procedure from our Network or from the manufacturer's website.

ACCESSING THE ENGINE, LEVELS

Windscreen washer reservoir



Topping up

Open the cap **3**, fill until you can see the fluid, then refit the cap.

Fluid

Only use windscreen washer fluid containing antifreeze.

We advise you to consult an approved dealer or a qualified professional.

Note: Do not use hard water (risk of damage to the priming pump, limescale building up on the pump and the jets).

BATTERY

Secondary 12 V battery



The secondary battery is a 12 V battery: it supplies the energy required to operate vehicle equipment (lights, windscreen wipers, windows, audio system, etc.) and certain safety systems such as braking assistance.

You should not open it or add any fluid.



Do not do any work under the bonnet when the vehicle is charging or when the ignition is switched on.

Maintenance/replacement

The secondary 12 V battery **1** charging status may diminish, especially if you use your vehicle:

- when the outside temperature drops;
- after extended use of energy-consuming devices with the engine switched off.



For your own safety and to ensure the proper operation of the vehicle's electrical equipment

(lights, windscreen wipers, ABS etc.), any intervention on the secondary "12 V" battery (removal, disconnection, etc.) must **ALWAYS** be performed by a specialist professional.

Risk of serious burns or electric shocks.

You **must** respect the replacement intervals (without exceeding them) as stated in the maintenance document.

The battery is a specific type. Please ensure it is replaced with the same type.

Call an approved Dealer.



The vehicle drive system in an electric vehicle uses a direct voltage of approximately 400 volts.

This system can get hot during and after switching off the ignition. Respect warning messages given on the labels in the vehicle.

Any intervention or modification on the vehicle's 400 V electrical system (components, cables, connectors, traction battery) is strictly prohibited.

The risk of serious burns or electric shocks can lead to death.

The engine cooling fan may also start at any moment. The warning

light  in the engine compartment reminds you of this.

Risk of injury.

BATTERY

Label A



Observe the indications on the battery.

2. Naked flames and smoking are forbidden.
3. Eye protection required.
4. Keep away from children.
5. Explosive materials.
6. Refer to the manual.
7. Corrosive substances.

Breakdown recovery

 To avoid damaging your vehicle, do not recharge the secondary 12 V battery using:

- an external battery charger;
- a battery from another vehicle.

Call an approved Dealer.

 Do not disconnect the secondary 12 V battery.
Risk of serious burns or electric shocks.

 Do not use your electric vehicle to restart the 12 volt battery in another vehicle. The 12 volt electric power of an electric vehicle is not enough to perform such an operation. Risk of damage to the vehicle.

CLEANING

Bodywork maintenance

Bodywork maintenance

A well-maintained vehicle will last longer. It is therefore recommended to maintain the exterior of the vehicle regularly.

Your vehicle has been treated with very effective anti-corrosion products. It is nevertheless subject to various outside influences.

Corrosive agents in the atmosphere

- atmospheric pollution (in built-up and industrial areas);
- saline atmospheres (near the sea, particularly in hot weather);
- seasonal and damp climatic conditions, (e.g.: road salt in winter, water from road cleaners, etc.).

Minor impacts

Abrasive action

Dust and sand in the air, mud, road grit thrown up by other vehicles, etc.

You should take a number of minor precautions in order to safeguard your vehicle against such risks.

You should do the following

Wash your car frequently, **with the engine off**, with cleaning products recommended by our Technical Depart-

ment (never use abrasive products). Rinse thoroughly beforehand using a jet washer:

- spots of tree resin and industrial pollution;
- mud in the wheel arches and underneath the body which forms damp patches;
- **bird droppings, which cause a chemical reaction with the paint that rapidly discolours paintwork and may even cause the paint to peel off.**

Wash the vehicle **immediately** to remove these marks as it is impossible to remove them by polishing;

- salt, particularly in the wheel arches and underneath the body after driving in areas where the roads have been gritted.

Withdraw the vegetable falls (resin, film etc.) from the vehicle regularly.

Observe the vehicle stopping distances when driving on gravelled surfaces to prevent paint damage.

Repair, or have repaired quickly, areas where the paint has been damaged, to prevent corrosion spreading.

Remember to visit the body shop periodically in order to maintain your anti-corrosion warranty. Refer to the maintenance document.

Observe local regulations about washing vehicles (e.g. do not wash your vehicle on a public highway).

When washing the vehicle with a high-pressure cleaning device, please take the following precautions:

- make sure that your vehicle's paintwork, the area or the component that you want to clean is compatible with this type of washing;
- the pressure delivered by the device must be less than 100 bar;
- when washing, position the spray nozzle at least 15 cm from the vehicle and check that the water flow rate is less than 3.30 gal (15 l)/min;
- do not persist in washing the same area, impacted points or the seals (risk of damage to the paint, seals becoming detached, etc.).

If mechanical components, hinges, etc. have been cleaned, they must be protected again by spraying with products approved by our Technical Department.



We have selected special products to care for your vehicle and you can obtain these from the manufacturer's accessory outlets.

CLEANING

Do not do the following

Wash the vehicle in bright sunlight or freezing temperatures.

Do not scrape off mud or dirt without pre-wetting.

Allow dirt to accumulate on the exterior.

Allow rust to form following minor impacts.

Using solvents not approved by our Technical Department to remove stains may damage the paintwork.

Do not drive in snow or muddy conditions without washing the vehicle, particularly under the wheel arches and body.



Degrease or clean using high-pressure cleaning equipment or by spraying products not approved by our Technical Department:

- mechanical components (e.g. engine compartment);
- wheels (e.g. braking system components such as brake callipers);
- the underbody;
- the parts with hinges (e.g. inside the doors);
- the painted plastic external fittings (e.g. bumpers).

Doing this could give rise to corrosion or operational faults.

Using a roller type car wash

Return the wiper stalk to the Park position → 161.

Check the mounting of external accessories, additional lights and rear view mirrors, and ensure that the wiper blades are secured with adhesive tape.

Remove the radio aerial mast if your vehicle is fitted with this equipment.

Remember to remove the tape and re-fit the antenna after washing.



Washing the vehicle

Never wash the engine compartment, the charging connection or the traction battery with a high-pressure jet.

This risks damaging the electric circuit.

Never wash the vehicle while it is charging.

Risk of electric shock and a risk to life.

Cleaning the headlights, sensors and cameras

Use a soft cloth or cotton wool.

If this is not sufficient, moisten the cloth with soapy water, always rinsing with a soft cloth or cotton wool.

Finally, carefully dry off with a soft dry cloth.

Do not use cleaning products containing alcohol or utensils (e.g. a scraper).

Cleaning stickers, decorative films, etc.

You should do the following

Use a soft cloth or cotton wool.

Moisten it slightly with soapy water then always wipe clean with a soft cloth or cotton wool.

Finally, carefully dry off with a soft dry cloth.

Do not do the following

Use alcohol-based cleaning products.

Use utensils (e.g. a scraper).

Rub too hard.



Wash the vehicle using a high-pressure cleaning device.

CLEANING

Interior trim maintenance

Interior trim maintenance

A well-maintained vehicle will last longer. It is therefore recommended to maintain the interior of the vehicle regularly.

A stain should always be dealt with swiftly.

Whatever the type of stain, use **cold (or tepid) soapy water prepared with natural soap**.

Detergents (washing-up liquid, powdered products, alcohol-based products) should not be used.

Use a soft cloth.

Rinse and wipe up excess water.

Multimedia screen

Maintenance of the screen may depend on the type of multimedia equipment. Please refer to the multimedia instructions for further information.

Glass instrument panel

(e.g. instrument panel, clock, exterior temperature display, etc.).

Use a soft cloth or cotton wool.

If this does not clean them properly, use a soft cloth (or cotton wool) slightly moistened with soapy water and then

wipe clean using another soft damp cloth or cotton wool.

Finally, dry off **carefully** with a soft dry cloth.

Do not use products containing alcohol and/or spray fluids on the area.

Seat belts

These must be kept clean.

Use products selected by our Technical Department (approved outlets) or warm, soapy water and a sponge and wipe with a dry cloth.

Detergents or dyes must not be used under any circumstances.

Textiles (seats, door trim, etc)

Vacuum-clean the textiles **regularly**.

Liquid stain

Use soapy water.

Dab lightly (never rub) with a soft cloth, rinse and remove the excess.

Solid or pasty stain

Carefully remove the excess solid or pasty material **immediately** using a spatula (working from the edges to the centre to avoid spreading the stain).

In the case of a liquid stain, clean as indicated.

Special instructions for sweets or chewing gum

Place an ice cube on the stain to solidify it then proceed as for a solid stain.



For further recommendations on maintaining the interior and/or in the event of unsatisfactory results, please consult an approved dealer.

Removal/replacing removable equipment originally fitted in the vehicle

If you need to remove equipment in order to clean the passenger compartment (for example, mats), always ensure that they are correctly refitted and are the right way around (the driver's mat should be fitted on the driver's side, etc.) and fit them with the components supplied with the equipment (for example, the driver mat should always be fixed using the pre-fitted mounting components).

With the vehicle stationary, always ensure that nothing will impede driving (anything obstructing the pedals, heel wedged by the mat etc.).

CLEANING

Do not do the following

Position objects such as deodorants, scents etc. near air vents as this could damage your dashboard trim.



Use high-pressure cleaning equipment or sprays inside the passenger compartment:

without careful use, this equipment could impair the correct functioning of the electrical or electronic components in the vehicle, or have other detrimental effects.

TYRES

Tyres

Maintaining the tyres

The tyres are the only contact between the vehicle and the road, so it is essential to keep them in good condition.

You must make sure that your tyres comply with the local regulations set out in the Highway Code.



The tyres must be in good condition and the tread form must have sufficient depth; tyres approved by our Technical Department have wear warning strips **1** which are **indicators moulded into the tread at several points.**

When the tyre tread has been worn to the level of the wear indicators, **they**

become visible 2: it is then necessary to replace your tyres because the tread rubber is 1.6 mm deep at most, resulting in poor road-holding on wet roads.

An overloaded vehicle, long journeys by motorway, particularly in very hot weather, or continual driving on poorly surfaced minor roads will lead to more rapid tyre wear and affect safety.



Incidents which occur when driving, such as striking the kerb, may damage the tyres and wheel rims, and could also lead to misalignment of the front or rear axle geometry. In this case, have the condition of these checked by an approved dealer.

Tyre pressures

Adhere to the tyre pressures. The tyre pressures should be checked at least once a month and additionally before any long journey (refer to the label affixed to the edge of the driver's door) **→ 346.**



Incorrect tyre pressures lead to abnormal tyre wear and unusually hot running. These are factors which may seriously affect safety and lead to:

- poor road holding;
- the risk of blow-outs or of throwing a tread.

The pressure depends on the load and the speed of use. Adjust the pressure according to the conditions of use (refer to the label affixed to the edge of the driver's door).

Pressures should be checked when the tyres are cold: ignore higher pressures which may be reached in hot weather or after the vehicle is driven at high speed.

If tyre pressures cannot be checked when the tyres are **cold, the pressure values indicated must be increased by 0.2 to 0.3 bar (or 3 PSI).**

Never deflate a hot tyre.

TYRES



Please be aware that a poorly tightened or missing valve cap can make the tyres less airtight and may lead to pressure loss. Always use valve caps identical to the originals and screw them down fully.



Vehicle fitted with a tyre pressure loss warning system

In the event of under-inflation

(punctures, etc.), the  warning light appears on the instrument panel → 187.



It is not permissible to exchange the 18" and 20" front wheels (tyres and/or rims) with the rear wheels.

Fitting new tyres

To fit new tyres, consult an approved dealer.



For your safety and to comply with the law. When they need to be replaced, only tyres of the same make, size, type and profile should be used on a single axle.

They must either have a load capacity and speed rating at least equal to those of the original tyres, or conform to those recommended by an authorised dealer.

Failure to heed these instructions could endanger your safety and affect your vehicle's roadworthiness.

Risk of loss of control of the vehicle.

Use in winter

Chains

For safety reasons, fitting snow chains to the rear axle is strictly forbidden.

Chains cannot be fitted to tyres which are larger than those originally fitted to the vehicle.

One-way tyres

An one-way tyre must only be fitted in one direction. You must observe this direction.

If an one-way tyre must be fitted in the opposite to its direction of rotation following a puncture, drive with caution, particularly on a wet road, because the tyre specifications will not be adapted.



If you wish to use **special equipment**, consult an approved dealer.

"Snow" or "Winter" tyres

We would recommend that these be fitted to all **four wheels** to ensure that your vehicle retains maximum adhesion.

Caution: these tyres sometimes have a specific direction of rotation and a maximum speed index which may be lower than the maximum speed for your vehicle.

TYRES



Chains may only be fitted to tyres of the same size as those originally fitted to **your vehicle**.

Chains may be fitted, provided that they are specific chains. We would advise you to consult an approved dealer.

Studded tyres

This type of equipment may only be used for a limited period and as laid down by local legislation. It is necessary to observe the speed specified by current legislation.

These tyres must, at a minimum, be fitted to the two front wheels.

Note: the use of snow tyres, winter tyres or studded tyres significantly reduces the vehicle range.



In all cases, we would recommend that you contact an approved Dealer who will be able to advise you on the choice of equipment which is most suitable for your vehicle.

Tyre pressure

Label A



Open the door to read it.

Tyre pressures should be checked when the tyres are cold.

If the tyre pressures cannot be checked when the tyres are **cold, increase the pressures by 0.2 to 0.3 bar (or 3 PSI). Never deflate a hot tyre.**

Tyre pressures must correspond to the current usage of the vehicle (empty, carrying a load, motorway driving, etc.). Observe inflation pressures.

These must be checked at least once a month and before any long journey.

Depending on the vehicle, after each reinflation or readjustment of the tyre pressure, you should reset the tyre pressure reference value → 187.

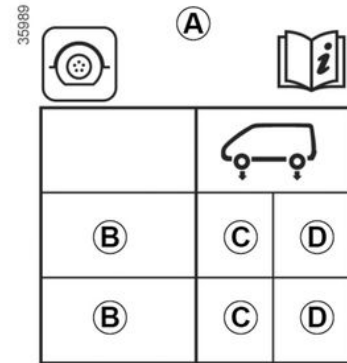

B. : dimension of the tyres fitted to the vehicle.

C. : tyre pressures for the front wheels.

D. : tyre pressures for the rear wheels.

TYRES

 **Vehicle fitted with a tyre pressure loss warning system**

In the event of under-inflation

(punctures, etc.), the  warning light appears on the instrument panel → 187.

 **Tyre safety and chain fitting:** for information on servicing conditions and, depending on the vehicle version, the use of chains → 344.

 **Vehicle used fully laden (Maximum Permissible All-up Weight) and towing a trailer**

The maximum speed must be limited to **62 mph (100 km/h)** and the tyre pressure increased by **0.2 bar** → 376.
Risk of tyre blowouts.



For your safety and to comply with the law. When they need to be replaced, only tyres of the same make, size, type and profile should be used on a single axle.

They must either have a load capacity and speed rating at least equal to those of the original tyres, or conform to those recommended by an approved dealer.

Failure to heed these instructions could endanger your safety and affect your vehicle's roadworthiness.

Risk of loss of control of the vehicle.

Tyre inflation kit

Tyre inflation kit



61660

6

TYRES



The kit repairs tyres when the tread **A** has been damaged by objects smaller than 6 mm.

It cannot repair all types of puncture, such as cuts larger than 6 mm, cuts in the tyre sidewall **B**, etc.

Ensure also that the wheel rim is in good condition.

Do not pull out the foreign body causing the puncture if it is still in the tyre.



Do not attempt to use the inflation kit if the tyre has been damaged as a result of driving with a

puncture.

You should therefore carefully check the condition of the tyre sidewalls before any operation. Driving with underinflated, flat or punctured tyres can be dangerous and may make the tyre impossible to repair.

This repair is temporary.

A tyre which has been punctured should always be inspected (and repaired, where possible) by a specialist as soon as possible. When taking a tyre which has been repaired using this kit to be replaced, you must inform the specialist.

When driving, vibration may be felt due to the presence of the repair product injected into the tyre.



The kit is only approved for inflating the tyres of the vehicle originally equipped with the kit.

It must never be used to inflate the tyres of another vehicle, or any other inflatable object (rubber ring, rubber boat, etc.).

Avoid spillage on skin when handling the repair product bottle. If droplets do leak out, rinse them off with plenty of water.

Keep the repair kit away from children.

Do not dispose of the empty bottle in the countryside. Return it to your approved dealer or to a recycling organisation.

The bottle has a limited service life which is indicated on its label.

Check the expiry date.

Contact an approved dealer to replace the inflation tube and repair product bottle.

TYRES



In the event of a puncture, use the kit located in the boot.



Vehicle fitted with a tyre pressure loss warning system

In the event of under-inflation

(punctures, etc.), the  warning light appears on the instrument panel → 187.

With the engine running and the parking brake applied:

- disconnect any accessories that are connected to the vehicle's accessories sockets;
- on vehicles fitted with a towing device, disconnect the towbar socket if needed;
- **see the information on the inflation kit compressor** located in the vehicle luggage compartment and follow the instructions for use;
- inflate the tyre to the recommended pressure → 344;
- after a maximum of **15 minutes**, stop inflating and read the pressure (on the pressure gauge 2);

Note: while the container is emptying (approximately 30 seconds), the pressure gauge 2 will briefly indicate a pressure value up to 6 bar, then the pressure will fall.

- Adjust the pressure: to increase it, continue inflating using the kit. To reduce it, press the button 1.

If the recommended pressure of 1.8 bar cannot be achieved after 15 minutes, repair is impossible. Do not drive the vehicle. Consult an approved dealer.



Before using the kit, park the vehicle at a sufficient distance from traffic, switch on the hazard warning lights, apply the parking brake, ask all passengers to leave the vehicle and keep them away from traffic.



If the vehicle is parked on the hard shoulder, you must warn other road users of your vehicle's presence with a warning triangle or with other devices as per the legislation applying to the country you are in.

TYRES

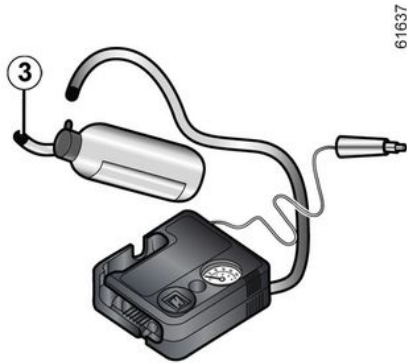

6

Once the tyre is correctly inflated, remove the kit: slowly unscrew the inflation adapter from the container **3** to prevent any product spatter, then store the container in plastic packaging to prevent the product from leaking.

- Affix the driving recommendation label (located under the container) to the dashboard where the driver can see it.
- Put the kit away.
- At the end of this initial inflation operation, air will still escape from the tyre. You must drive a short distance in order to seal the hole.
- Start immediately and drive at a speed between 12 to 37 mph (20 to 60 km/h) in order to distribute the product evenly in the tyre. After driving a dis-

tance of 2 miles (3 km), stop and check the pressure.
– If the pressure is higher than 1.3 bar but lower than the recommended pressure (refer to the label affixed to the edge of the driver's door), adjust it. Otherwise, contact an approved dealer: the tyre cannot be repaired.

Precautions when using the kit

The kit should not be operated for more than 15 consecutive minutes.

The container must be replaced after the first use even if liquid remains inside.



Nothing should be placed around the driver's feet as during sudden braking such objects may slide under the pedals and obstruct their use.



Please be aware that a poorly tightened or missing valve cap can make the tyres less airtight and may lead to pressure loss. Always use valve caps identical to the originals and screw them down fully.



Following repair with the kit, do not travel further than 124 miles (200 km). In addition, reduce your speed and under no circumstances exceed 50 mph (80 km/h). The sticker, which you must affix in a prominent position on the dashboard, reminds you of this. Depending on the country or local legislation, a tyre repaired with the inflation kit will need to be replaced.

TYRES

Tools

Tool kit

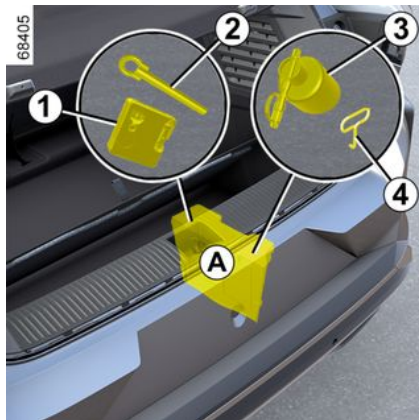

The tools included in the tool kit depend on the vehicle.

The tool kit **A** is located underneath the carpet in the luggage compartment.

The tool kit includes a tyre inflation kit compressor **1** → **347**, a towing eye **2** → **353** and, depending on the vehicle, a container of anti-puncture product **3** and a hubcap tool **4**.

After use, ensure the tools are correctly stored.



Do not leave the tools unsecured inside the vehicle as they may be projected during braking.

After use, check that all the tools are correctly clipped into the tool kit, then position it correctly in its housing to reduce the risk of injury.



Removing the central wheel trim may damage or break it.

Central wheel trim 3

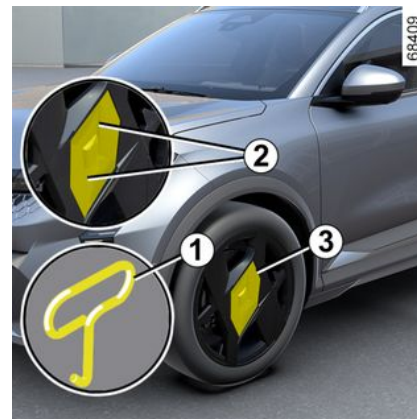

Remove it using the hubcap tool **1** (located in the tool kit), by fitting the hook into one of the notches **2** on the central wheel trim **3**. Pull the hubcap tool until one of the fasteners is completely removed. Repeat the procedure on the other notch **2**. Pull the ends of the central wheel trim with your hands until it is completely removed.

To reposition the central wheel trim **3**, position and centre the central wheel trim in parallel above the wheel. Press hard on the ends of the wheel trim to attach the fasteners to the wheel, until they are fully fitted to the wheel. Make sure it is correctly positioned by pressing the central part of the wheel trim.

TYRES



Removing the central wheel trim **may damage or break it.**

BREAKDOWN RECOVERY

Towing: breakdown

Breakdown recovery

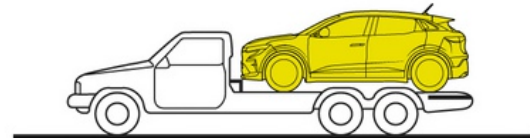
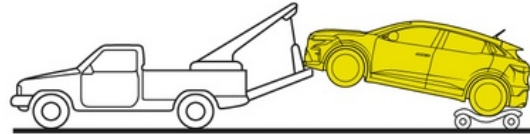
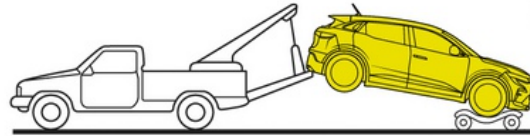
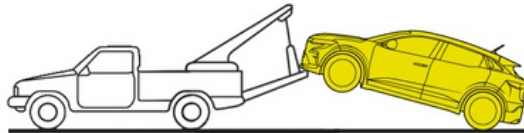

6:1645

BREAKDOWN RECOVERY

Before any towing, including on a flatbed truck, set the gear control to position N and release the parking brake.

The speed specified by current legislation for towing must always be observed.

If you are driving the towing vehicle, do not exceed the maximum towing weight for your vehicle ➔ 376.

To recover a vehicle on a flatbed or tow the vehicle using a towing point, observe the following instructions:

- with the card in the passenger compartment, press the engine start button;
- Set the gear control to the N ➔ 170 position: the parking brake is released;
- press the engine Start button for more than two seconds. The accessories functions are powered: you can use the vehicle lighting functions (hazard warning lights, brake lights, etc.). At night the vehicle lights must be on;
- once you have finished towing, press the engine start button for more than two seconds (risk of discharging the battery).

Choice of towing

It is strictly forbidden to tow the vehicle with the front wheels on the ground.



Do not leave the tools unsecured inside the vehicle as they may be projected during braking.



When the engine is stopped, steering and braking assistance are no longer provided.

Access to towing points

Use only the front 2 and rear 5 towing points (never use the drive shafts or any other part of the vehicle). These towing points may only be used for pulling. They must never be used for lifting the vehicle directly or indirectly.

Note: be sure to protect the towing point area with a cloth when using a flat screwdriver or similar tool.

Screw in the tow eye 3 by hand as far as possible.

You must only use the towing eye 3.



Ensure that the towing eye is bolted correctly.
Risk of losing the towed object.

Standard version

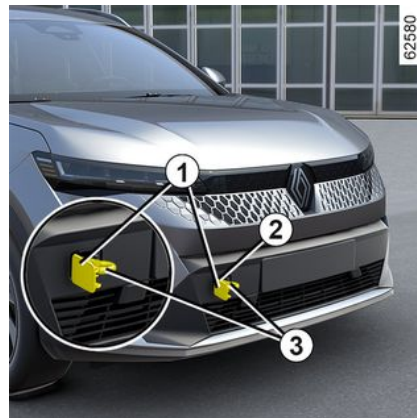

Front towing point

Press the upper section of the flap 1 to tilt it.

BREAKDOWN RECOVERY



- Use a rigid tow bar. If a rope or cable is used (where the law allows this), the vehicle being towed must be able to brake.
- a vehicle must not be towed if it is not fit to be driven.
- avoid accelerating or braking suddenly when towing, as this may result in damage being caused to the vehicle.
- In any case, it is advisable not to exceed **16 mph (25 km/h)**.

Press zone **A** and maintain the pressure while pulling zone **B** (using a flat-blade screwdriver or similar tool) to open the flap **4**.

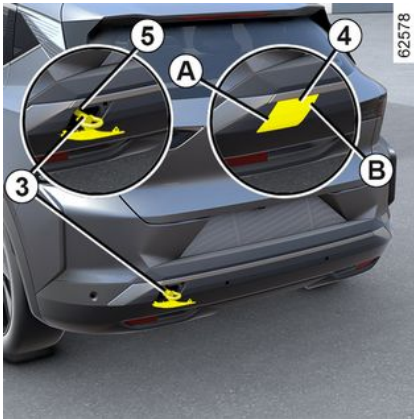

Rear towing point

HEADLIGHTS, LIGHTS: REPLACING BULBS

Exterior lighting: replacing bulbs

Front headlights

LED dipped beam/main beam headlights 1



Consult an approved dealer.

LED daytime running lights/side lights/direction indicators 2

Consult an approved dealer.



Any operation on (or modification to) the electrical system must be performed by an approved Dealer since an incorrect connection might damage the electrical equipment (harness, components and in particular the alternator). In addition, your Dealer has all the parts required for fitting these units.

Rear and indicator lights

LED high-level brake light 1

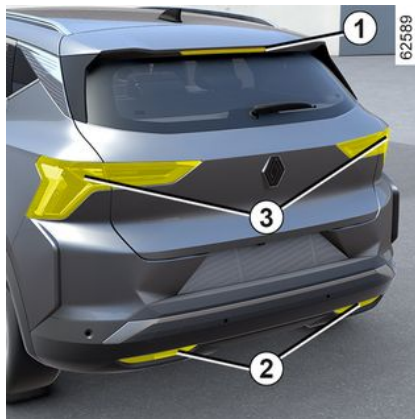

Consult an approved dealer.

LED reversing lights and rear fog lights 2

Consult an approved dealer.

LED direction indicator/brake and side lights 3

Consult an approved dealer.

LED number plate lights 4



Consult an approved dealer.

HEADLIGHTS, LIGHTS: REPLACING BULBS

Side indicator lights 5



Consult an approved dealer.

Interior lighting: changing bulbs

Reading lights 1 and 2

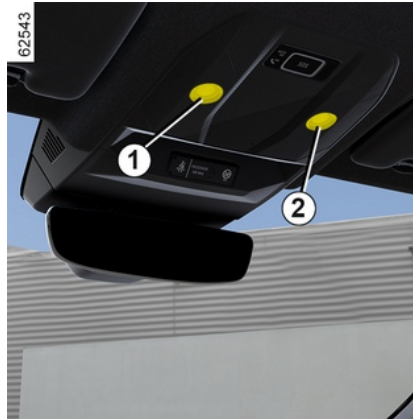

Consult an approved dealer.

Courtesy mirror lights 3



Consult an approved dealer.

HEADLIGHTS, LIGHTS: REPLACING BULBS

Light for luggage compartment 4



Consult an approved dealer.

WIPER BLADES: REPLACEMENT

Replacing windscreen wiper blades 2

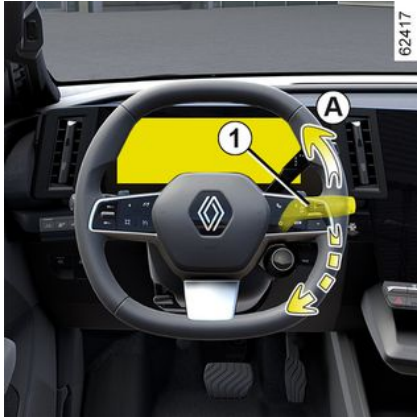

To replace the wipers, first put them in the service position **B**.

With the ignition on and the engine stopped:

- move the stalk **1** twice in succession to position **A** (single sweep): the wiper blades will stop in the service position **B** away from the bonnet;
- press the button **4** then remove the blade upwards.

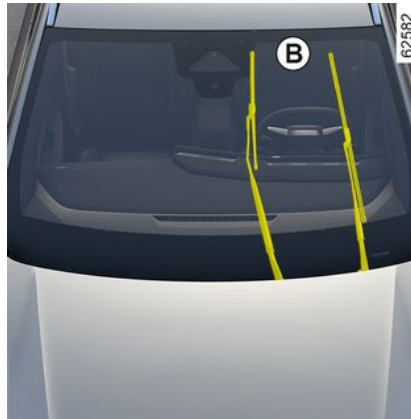

Refitting

To refit the wiper blade **2**, insert it into its housing in the arm **3**, then clip it until you hear a click. Make sure that the blade is correctly locked in position.

To return the blades to the lowered position, make sure that the blades are folded down onto the windscreen then set the stalk **1** to position **A** (single sweep): the windscreen wiper blades will fold into the bonnet when the ignition is switched on.

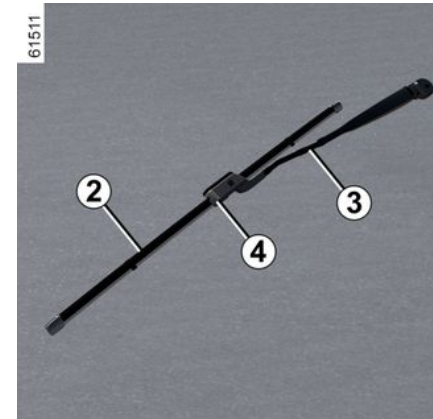

 Check the condition of the wiper blades. You are responsible for their service life:

- clean the blades and the windscreen regularly with soapy water;
- do not use them when the windscreen is dry;
- free them from the windscreen when they have not been used for a long time.

WIPER BLADES: REPLACEMENT

Rear screen wiper blade 5

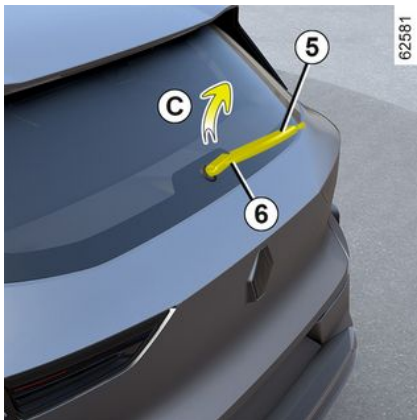

The stalk in the off position (deactivated):

- lift the wiper arm **6**;
- rotate the rear screen wiper blade **5** (movement **C**) until it unclips;
- release the rear screen wiper blade **5** by pulling it.

Refitting

To refit the wiper blade, proceed in the reverse order to removal. Make sure that the blade is correctly locked in position.



Check the condition of the wiper blades. You are responsible for their service life:

- clean the blades and the windscreen regularly with soapy water;
- do not use them when the windscreen is dry;
- free them from the windscreen when they have not been used for a long time.



- In frosty weather, make sure that the wiper blades are not stuck by ice (to avoid the risk of the motor overheating).
- Check the condition of the wiper blades.

Replace the wiper blades as soon as they begin to lose efficiency (approximately once a year). Whilst changing the blade, take care not to drop the arm onto the window after it has been removed as this may break the window.



Before changing the rear wiper blade, make sure the stalk is in the stop position (deactivated).

Risk of injury.

FUSES

Fuse box



If any electrical component does not work, check the condition of the fuses. The fuses can be accessed behind the glovebox **A**. Open the glovebox **A** using the opening button **1**.

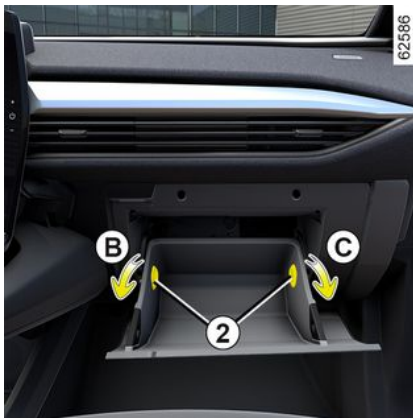

Once open, turn the stops **2** a quarter of a turn (movements **B** and **C**) to remove them.

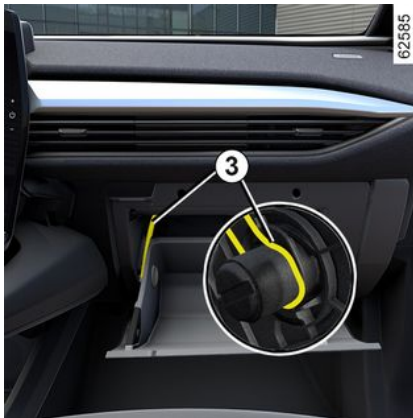

Unhook the wire **3** to release the glovebox door in order to access the fuse box.



Move the glovebox door **A** downwards as far as possible.

You will then have direct access to the fuse box **4**.

FUSES

Fuse box *D*



Unclip the flap **5**.

Clamp **6**

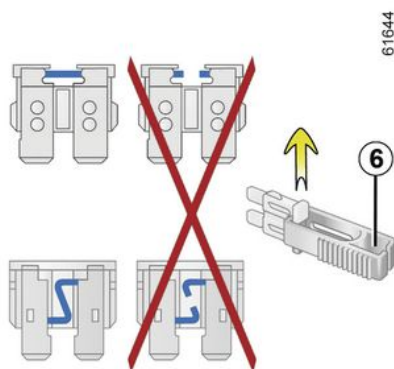

Remove the fuse using the clamp **6** located on the fuse panel.

To remove the fuse from the tweezers, slide the fuse to the side.

It is not advisable to use the free fuse locations.



Check the fuse in question and, **if necessary, replace it (replacement fuse must have the same rating as the original.**

If a fuse is fitted with too high a rating, it may cause the electrical circuit to overheat (risk of fire) in the event of an item of equipment using an excessive amount of current.



To comply with local legislation or as a precautionary measure:

Obtain an emergency kit containing a set of spare bulbs and fuses from an approved Dealer.

Allocation of fuses

(the presence of certain fuse depends on the vehicle equipment level)

FUSES

Number	Allocation
1	ESP/ABR ECU Brake Switch
2	Right-hand rear window control motor
3	Driver's side window control motor
4	Interior lighting
5	Left-hand rear window control motor
6	Towbar socket/luggage compartment accessories socket
7	Front seat position memory ECU and front seat adjustment control
8	Retractable electric handle
9	Passenger side window control motor
10	Electric rear view mirror
11	Towbar socket communication module
12	Multimedia accessories sockets/Left-hand and right-hand side radar/SRVM

Number	Allocation
13	Right-hand rear exterior opening control
14	Right-hand front exterior opening control
15	Left-hand front exterior opening control
16	Rear screen de-icer/Heated rear screen interference filter
17	Retractable electric handle
18	1st row accessories socket
19	Radio
20	Ambient light
21	Pre-equipment for accessories
22	Rain and light sensor

IMPORTANT RECOMMENDATIONS



Electrical and electronic accessories

Before installing this type of accessory (particularly for transmitters/receivers: frequency bandwidth, power level, position of the aerial, etc.), make sure it is compatible with your vehicle. Contact an approved dealer.

Before connecting an accessory to a socket, please ensure that it does not exceed the maximum power authorised for the socket → 317 → 322. **Fire hazard.**

No work may be carried out on the vehicle's electrical and/or electronic circuits, except by a qualified professional. In fact, an incorrect connection and/or the installation of electrical/electronic accessories not approved by the manufacturer could lead to:

- damage to the electrical and/or electronic equipment;
- damage to the components connected to it;
- the collection and use of vehicle data;
- an invasion of privacy (modification, deletion or unwarranted access to personal data);
- cancellation of the authorisation for entry into service.

Risk of serious accidents. Risk of invasion of privacy.

If you have electrical equipment fitted in future, make sure that you are notified of the rating and position of the corresponding fuse.

Using the diagnostic socket

The use of electronic accessories on the diagnostic socket may cause serious disturbance to the vehicle's electronic systems and/or cause invasion of privacy (modification, deletion or unwarranted access to personal data). For your safety we recommend that you use only electronic accessories approved by the manufacturer, consult an approved dealer. **Risk of serious accidents. Risk of invasion of privacy.**

Fitting aftermarket accessories

If you wish to install accessories on the vehicle: consult an approved dealer. Also, to ensure the correct operation of your vehicle, and to avoid any risk to your safety, we recommend that you use only accessories specifically designed for your vehicle, which are the only accessories for which the manufacturer will provide a warranty.

If you are using an anti-theft device, only attach it to the brake pedal.

Driver obstruction

IMPORTANT RECOMMENDATIONS

On the driver's side, only use mats suitable for the vehicle, attached with the pre-fitted components, and check the fitting regularly. Do not lay one mat on top of another. **There is a risk of wedging the pedals.**

OPERATING FAULTS

The following advice will enable you to carry out quick, temporary repairs. For safety reasons you should always contact an approved dealer as soon as possible.

FAULTS	POSSIBLE CAUSES	ACTION REQUIRED
Impossible to charge the traction battery.	The outdoor temperature is lower than -26°C.	Recharge your vehicle in a more suitable environment. If necessary → 353.
The charging flap warning light flashes red.	No electrical current in the wall socket or poor connection of the cable in the domestic socket.	Check your installation (circuit breaker, programmer, etc.). Check the connections (charging socket, etc.) → 20.
	The cord is defective.	Please see an authorised dealer to replace it.
Impossible to charge the traction battery. The charging flap warning light flashes blue.	The charging cord is not correctly locked to the vehicle.	Connect the charging cable correctly to the vehicle → 20.

FAULTS	POSSIBLE CAUSES	ACTION REQUIRED
The card does not lock or unlock the doors.	Card battery is flat.	Replace the battery or have it replaced. You will still be able to lock, unlock, and start your vehicle → 64 and → 167.
	Use of appliances operating on the same frequency as the remote control (mobile phone, etc.).	Stop using the devices or use the built-in key → 64.
	Vehicle located in a high electromagnetic radiation zone. Secondary 12 volt battery discharged.	Use the key that is built into the card → 64.
	Desynchronisation of the card.	Unlock the driver's door by inserting the card's built-in key into the door lock → 64, then place the card on the placement

OPERATING FAULTS

FAULTS	POSSIBLE CAUSES	ACTION REQUIRED
		area ➔ 167 and press the "START" button to synchronise the card.
The "Place the card near the START button" message appears on the instrument panel.	The card battery is flat or the card is out of synch.	Check the card battery status or place the card in the dedicated placement area ➔ 167 .

FAULTS	POSSIBLE CAUSES	ACTION REQUIRED
Steering becomes heavy.	Assistance overheating.	Drive carefully at reduced speed, be aware of the level of force in the steering wheel needed to turn the wheels.
	Fault with the electric assistance motor. Fault in the assistance system.	Consult an approved Dealer.

Electrical equipment	POSSIBLE CAUSES	ACTION REQUIRED
Vibrations.	Tyres not inflated to the correct pressure, incorrectly balanced or damaged.	Check the tyre pressures. If this is not the problem, have them checked by an approved Dealer.
The wipers do not work.	Wiper blades stuck.	Free the blades before using the wipers.
	Broken windscreen wiper fuse.	Consult an approved Dealer.
	Blown rear screen wiper fuse (intermittent, permanently stopped).	Replace the fuse or have it replaced ➔ 361 .
	Motor fault.	Consult an approved Dealer.
The wiper does not stop.	Faulty electrical controls.	Consult an approved Dealer.

OPERATING FAULTS

Electrical equipment	POSSIBLE CAUSES	ACTION REQUIRED
Direction indicators flashing more quickly.	Faulty bulb.	Consult an approved Dealer.
The indicators are not working.	On one side: Faulty bulb.	Consult an approved Dealer.
	On both sides: – blown fuse; – Faulty electrical circuit or control.	Replace the fuse or have it replaced → 361. Replace: contact an approved dealer.

Electrical equipment	POSSIBLE CAUSES	ACTION REQUIRED
The headlights are not working.	One only: – Faulty bulb; – disconnected wire or incorrectly-positioned connector.	Consult an approved Dealer. Consult an approved Dealer.
	Both: Fuse damaged.	Replace the fuse or have it replaced → 361.
The headlights do not switch off.	Faulty electrical controls.	Consult an approved Dealer.
Traces of condensation in the headlights or rear lights.	Traces of condensation may be a natural phenomenon caused by variations in temperature and humidity. In this case, the traces will disappear slowly once the lights are switched on.	

Stopped	POSSIBLE CAUSES	ACTION REQUIRED
The air conditioning and ventilation fan switch on after the ignition is switched off or when the vehicle is being charged.	This is not necessarily a fault, the air conditioning compressor and the ventilation fan switch on to regulate the temperature of the system when the exterior temperature is low.	

OPERATING FAULTS

Stopped	POSSIBLE CAUSES	ACTION REQUIRED
	The air conditioning compressor and the ventilation fan switch on for more than 30 minutes when the ignition is switched off.	Consult an approved Dealer.
The programmable air conditioning fails to work.	One of the usage conditions is not complied with (the traction battery is not charged, etc).	➔ 313.
The passenger compartment air conditioning and the heating functions are switched off with no action by the user, even if the battery is sufficiently charged.	This is not necessarily a fault, the system switches off by default to preserve battery autonomy or optimise recharging.	To enter the extended life on board mode, press the Start button without pressing the brake pedal. The air conditioning nevertheless stops after a few minutes. You can always reactivate the system by pressing the air conditioning controls ➔ 309.
	Electrical fault.	Consult an approved Dealer.

INFORMATION ABOUT THE VEHICLE

Vehicle identification plates

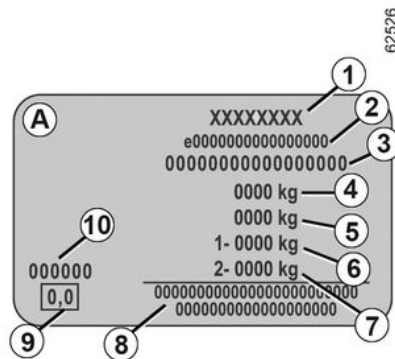
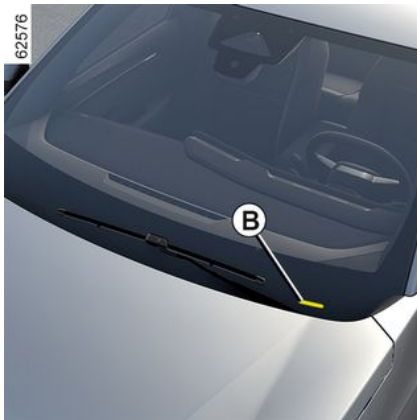

The information shown on the vehicle identification plate should be quoted on all correspondence or orders.

The presence and location of the information depends on the vehicle.

Identification plate A

1. Manufacturer name.
2. EC design number or approval number.
3. Identification number.

B. Depending on the vehicle, this information is also provided on the marking .

4. MTR (Maximum permissible all-up weight).

5. MTR (Gross Train Weight: vehicle fully loaded, with trailer).

6. MMTA (Maximum Permissible Weight) front axle.

7. MMTA rear axle.

8. Area reserved for related or additional entries.

9. Paint reference (colour code).

Technical Information for the emergency services



The QR Code on label **A** allows emergency workers using a tablet or smartphone to immediately access the technical information useful for working on the vehicle in the event of an accident.

INFORMATION ABOUT THE VEHICLE

Ensure that the label **A** is always visible and present on the windscreen as well as the rear screen.

Any modification or damage would prevent access to the information.

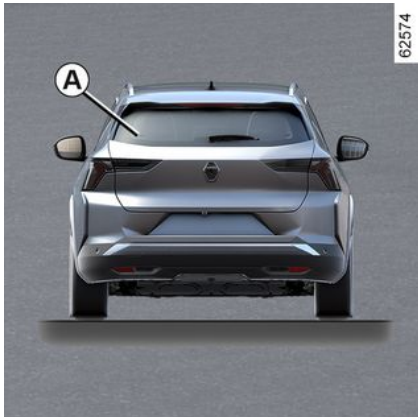

Engine identification, engine specifications

Engine identification

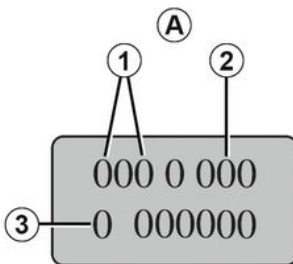

Engine specifications



Engine type: 6AM

Please quote the information on the engine plate or label **A in all correspondence or orders.**

(Location varies depending on engine)

1. Engine type.
2. Engine suffix.
3. Engine serial number.

INFORMATION ABOUT THE VEHICLE

Information on lifting



Your vehicle is equipped with four dedicated lifting points **1** located underneath the vehicle.



For your safety, we recommend that you contact an approved dealer to change the wheels.

Risk of damage to the vehicle and particularly to the electric traction battery in the event of incorrect positioning of the lifting equipment.

The lifting points are compatible with the use of a jack equipped with a flat plate and a diameter between **80 mm** and **140 mm**.

The jack used must comply with the country's current standards and regulations. The jack lifting capacity must be greater than the vehicle's maximum permissible weight on the relevant axle → **371**.

The jack is only to be used to lift the vehicle in order to change the wheels. This must be performed:

- with the parking brake applied,
- with the vehicle unladen,
- on level, non-slip and solid ground.

Before lifting the vehicle, the plate of the jack must be correctly positioned against the lifting point **1**.

Place the jack horizontally: the jack head **must** be lined up with the sill **1** closest to the wheel concerned, as shown by an arrow **2**.



To prevent any risk of injury or damage to the vehicle, the jack must only be cranked until the wheel you are replacing is at most three centimetres off the ground.
Risk of injury. Risk of damage to the vehicle.



For safety reasons, the vehicle lifting points must only be used to change the wheels. Under no circumstances should they be used:

- to carry out a repair;
- to access the underside of the vehicle.

Risk of injury. Risk of damage to the vehicle.

INFORMATION ABOUT THE VEHICLE

Dimensions (in metres)

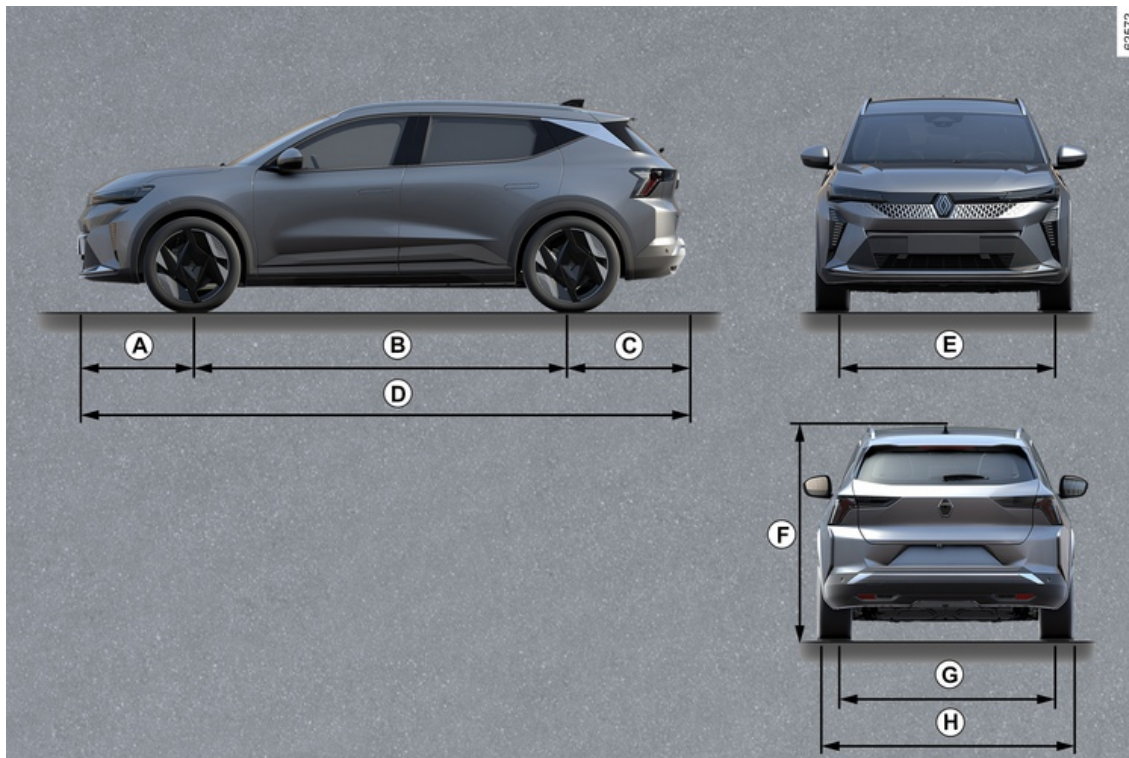

7

INFORMATION ABOUT THE VEHICLE

	Length
A	0,840
B	2,784
C	0,843
D	4,468
E	1.625 to 1.635
F	1,572 unladen
G	1.620 to 1.630
H	1,864 2.085 with door mirrors folded out 1.908 with door mirrors folded in

INFORMATION ABOUT THE VEHICLE

Weights (in kg)

7

INFORMATION ABOUT THE VEHICLE

(in kg)

<p>The weights indicated are for a basic vehicle without optional fittings: they vary according to your vehicle's equipment. Consult your approved dealer.</p>	
<p>Maximum Permissible All-up Weight (MMAC) Maximum Permissible Weight (MMTA) Gross Train Weight (MTR)</p>	<p>Weights indicated on the manufacturer's plate → 371</p>
<p>Braked Towing Weight *</p>	<p>found by calculating: MTR - MMAC</p>
<p>Unbraked Towing Weight *</p>	<p>750 kg</p>
<p>Permissible nose weight *</p>	<p>75 kg</p>
<p>Maximum permissible load on roof</p>	<p>80 kg (including carrying device)</p>
<p>* Towing weight (towing a caravan, boat, etc.) Towing is prohibited when the MTR - MMAC calculation is equal to zero, or when the MTR is equal to zero (or is not indicated) on the manufacturer's plate.</p> <ul style="list-style-type: none"> – It is important to respect local towing regulations in force, specifically those set out in the Highway Code. Contact an approved dealer for any modifications to towing equipment. – For vehicles fitted with a trailer, the total train weight (vehicle + trailer) must never be exceeded. However the following is tolerated: <ul style="list-style-type: none"> – rear MMTA exceeded by up to 15%; – MMAC exceeded by up to 10% or 100 kg (whichever limit is reached first). <p>In either case, the maximum speed of the vehicle and trailer must not exceed 62 mph (100 km/h) and the tyre pressures must be increased by 0.2 bar (3 PSI).</p>	

REPLACEMENT PARTS AND REPAIRS

Original parts are based on very stringent specifications and are subjected to specific tests. Therefore, they are of at least the same level of quality as the parts fitted originally.

If you always fit genuine replacement parts to your vehicle, you will ensure that it performs well. Furthermore, repairs carried out in the approved dealer network with original parts are guaranteed according to the conditions stated on the back of the repair order.

SERVICE SHEETS

VIN:

Date:	Miles (km):	Invoice number:	Comments/miscellaneous
Type of operation: Service <input type="checkbox"/> <input type="checkbox"/>		Stamp	
Anticorrosion check: OK <input type="checkbox"/> Not OK* <input type="checkbox"/>			
Date:	Miles (km):	Invoice number:	Comments/miscellaneous
Type of operation: Service <input type="checkbox"/> <input type="checkbox"/>		Stamp	
Anticorrosion check: OK <input type="checkbox"/> Not OK* <input type="checkbox"/>			
Date:	Miles (km):	Invoice number:	Comments/miscellaneous
Type of operation: Service <input type="checkbox"/> <input type="checkbox"/>		Stamp	
Anticorrosion check: OK <input type="checkbox"/> Not OK* <input type="checkbox"/>			

* See specific page

SERVICE SHEETS

VIN:

Date:	Miles (km):	Invoice number:	Comments/miscellaneous
Type of operation: Service <input type="checkbox"/> <input type="checkbox"/>		Stamp	
Anticorrosion check: OK <input type="checkbox"/> Not OK* <input type="checkbox"/>			
Date:	Miles (km):	Invoice number:	Comments/miscellaneous
Type of operation: Service <input type="checkbox"/> <input type="checkbox"/>		Stamp	
Anticorrosion check: OK <input type="checkbox"/> Not OK* <input type="checkbox"/>			
Date:	Miles (km):	Invoice number:	Comments/miscellaneous
Type of operation: Service <input type="checkbox"/> <input type="checkbox"/>		Stamp	
Anticorrosion check: OK <input type="checkbox"/> Not OK* <input type="checkbox"/>			

7

* See specific page

SERVICE SHEETS

VIN:

Date:	Miles (km):	Invoice number:	Comments/miscellaneous
Type of operation: Service <input type="checkbox"/> <input type="checkbox"/>		Stamp	
Anticorrosion check: OK <input type="checkbox"/> Not OK* <input type="checkbox"/>			
Date:	Miles (km):	Invoice number:	Comments/miscellaneous
Type of operation: Service <input type="checkbox"/> <input type="checkbox"/>		Stamp	
Anticorrosion check: OK <input type="checkbox"/> Not OK* <input type="checkbox"/>			
Date:	Miles (km):	Invoice number:	Comments/miscellaneous
Type of operation: Service <input type="checkbox"/> <input type="checkbox"/>		Stamp	
Anticorrosion check: OK <input type="checkbox"/> Not OK* <input type="checkbox"/>			

* See specific page

SERVICE SHEETS

VIN:

Date:	Miles (km):	Invoice number:	Comments/miscellaneous
Type of operation:		Stamp	
Service <input type="checkbox"/>			
..... <input type="checkbox"/>			
Anticorrosion check:			
OK <input type="checkbox"/> Not OK* <input type="checkbox"/>			
Date:	Miles (km):	Invoice number:	Comments/miscellaneous
Type of operation:		Stamp	
Service <input type="checkbox"/>			
..... <input type="checkbox"/>			
Anticorrosion check:			
OK <input type="checkbox"/> Not OK* <input type="checkbox"/>			
Date:	Miles (km):	Invoice number:	Comments/miscellaneous
Type of operation:		Stamp	
Service <input type="checkbox"/>			
..... <input type="checkbox"/>			
Anticorrosion check:			
OK <input type="checkbox"/> Not OK* <input type="checkbox"/>			

* See specific page

SERVICE SHEETS

VIN:

Date:	Miles (km):	Invoice number:	Comments/miscellaneous
Type of operation: Service <input type="checkbox"/> <input type="checkbox"/>		Stamp	
Anticorrosion check: OK <input type="checkbox"/> Not OK* <input type="checkbox"/>			
Date:	Miles (km):	Invoice number:	Comments/miscellaneous
Type of operation: Service <input type="checkbox"/> <input type="checkbox"/>		Stamp	
Anticorrosion check: OK <input type="checkbox"/> Not OK* <input type="checkbox"/>			
Date:	Miles (km):	Invoice number:	Comments/miscellaneous
Type of operation: Service <input type="checkbox"/> <input type="checkbox"/>		Stamp	
Anticorrosion check: OK <input type="checkbox"/> Not OK* <input type="checkbox"/>			

* See specific page

SERVICE SHEETS

VIN:

Date:	Miles (km):	Invoice number:	Comments/miscellaneous
Type of operation:		Stamp	
Service <input type="checkbox"/>			
..... <input type="checkbox"/>			
Anticorrosion check:			
OK <input type="checkbox"/> Not OK* <input type="checkbox"/>			
Date:	Miles (km):	Invoice number:	Comments/miscellaneous
Type of operation:		Stamp	
Service <input type="checkbox"/>			
..... <input type="checkbox"/>			
Anticorrosion check:			
OK <input type="checkbox"/> Not OK* <input type="checkbox"/>			
Date:	Miles (km):	Invoice number:	Comments/miscellaneous
Type of operation:		Stamp	
Service <input type="checkbox"/>			
..... <input type="checkbox"/>			
Anticorrosion check:			
OK <input type="checkbox"/> Not OK* <input type="checkbox"/>			

* See specific page

ANTICORROSION CHECK

If the continuation of the warranty is subject to repair, it is indicated below.

VIN:

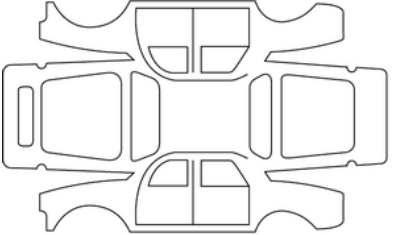
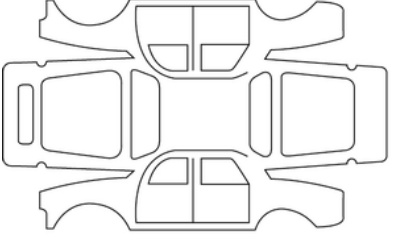
Date of repair:		Stamp
Corrosion repair operation to be carried out:		
Date of repair:		Stamp
Repair to be carried out:		

ANTICORROSION CHECK

If the continuation of the warranty is subject to repair, it is indicated below.

VIN:

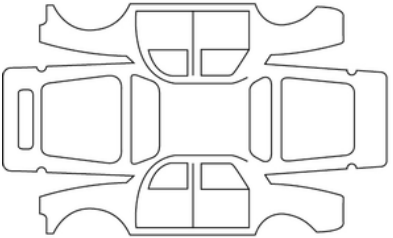
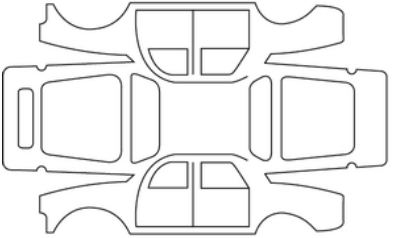
Date of repair:		Stamp
Corrosion repair operation to be carried out:		
Date of repair:		Stamp
Repair to be carried out:		

7

ANTICORROSION CHECK

If the continuation of the warranty is subject to repair, it is indicated below.

VIN:

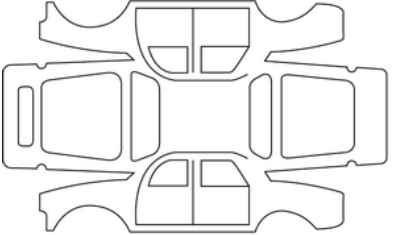
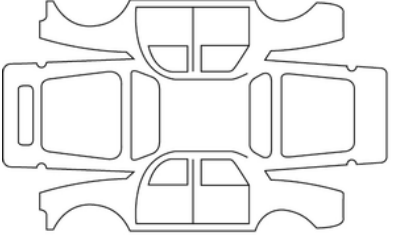
Date of repair:		Stamp
Corrosion repair operation to be carried out:		
Date of repair:		Stamp
Repair to be carried out:		

ANTICORROSION CHECK

If the continuation of the warranty is subject to repair, it is indicated below.

VIN:

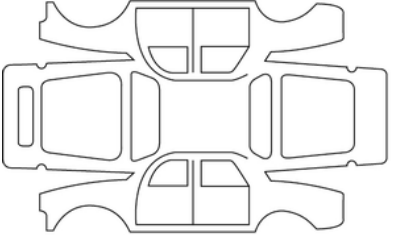
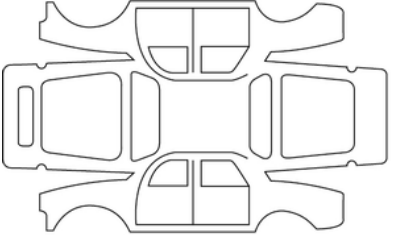
Date of repair:		Stamp
Corrosion repair operation to be carried out:		
Date of repair:		Stamp
Repair to be carried out:		

7

ANTICORROSION CHECK

If the continuation of the warranty is subject to repair, it is indicated below.

VIN:

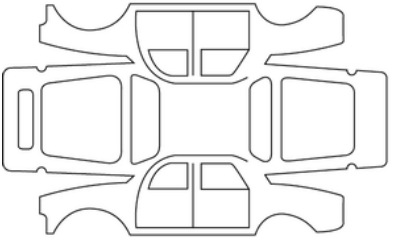
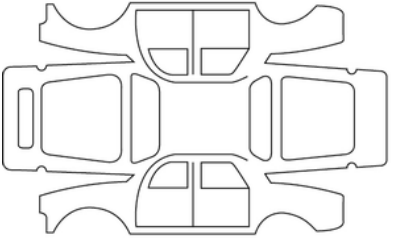
Date of repair:		Stamp
Corrosion repair operation to be carried out:		
Date of repair:		Stamp
Repair to be carried out:		

ANTICORROSION CHECK

If the continuation of the warranty is subject to repair, it is indicated below.

VIN:

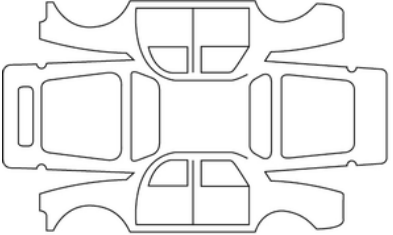
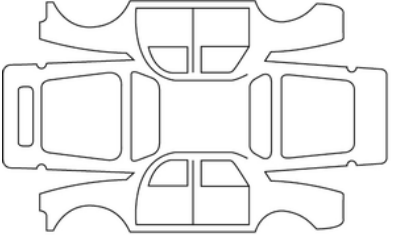
Date of repair:		Stamp
Corrosion repair operation to be carried out:		
Date of repair:		Stamp
Repair to be carried out:		

7

ANTICORROSION CHECK

If the continuation of the warranty is subject to repair, it is indicated below.

VIN:

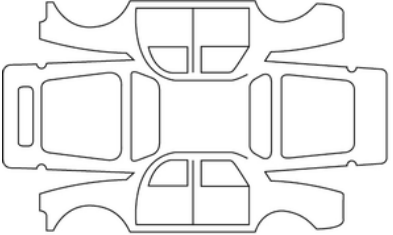
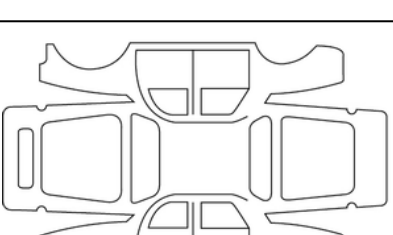
Date of repair:		Stamp
Corrosion repair operation to be carried out:		
Date of repair:		Stamp
Repair to be carried out:		

ALPHABETICAL INDEX

Symbols

"400 volt" electrical circuit, [20](#)
"Hands-free" card: battery, [58](#)
"Hands-free" card: use, [54](#)
12 V battery: maintenance, [338](#)
12 volt battery, [20](#), [338](#)
360° camera, [286](#)

A

ABS, [192](#)
Accessing the vehicle, [54](#), [58](#)
Accessories socket, [322](#)
Access to the engine compartment, [333](#)
Active driver assist, [233](#), [233](#)
Active emergency braking in reverse gear, [248](#)
Adaptive cruise control, [255](#)
Additional restraint devices, [88](#)
Airbag, [88](#), [93](#)
Airbag : activating the front passenger airbag, [117](#)
Airbag: airbag, [88](#)
Airbag : deactivating the front passenger airbag, [117](#)
Airbags : child safety, [117](#)
Air conditioning, [313](#)
Air conditioning: information and advice for use, [315](#)
Air Vents, [305](#)
Anti-lock braking system : ABS, [192](#)
Assistance: driving aid, [255](#)
Audible and visual signals, [160](#)

Automatic tailgate, [70](#)

B

Battery, [338](#)
Blinds, sun visor, [322](#)
Blind spot: warning, [211](#)
Blind spot warning, [211](#)
Bodywork (maintenance), [340](#)
Bonnet, [333](#)
Breakdown recovery towing, [353](#)
Bulbs: replacement, [356](#), [356](#)

C

Camera rear view, [148](#)
Card: deadlocking, [58](#)
Card: emergency key, [52](#)
Card: engine not starting in hands-free mode, [52](#)
Card: hands-free, [52](#), [54](#)
Card: locking/unlocking the opening elements, [52](#), [58](#)
Card: use, [58](#)
Card RENAULT: use, [54](#)
Central door locking, [58](#)
Changing bulbs, [356](#), [356](#)
Charging cable, [46](#)
Charging connection, [20](#)
Charging programming, [46](#)
Children, [97](#)
Children (safety), [319](#)

ALPHABETICAL INDEX

Child restraint, [97](#)
Child restraint devices, [97](#)
Child restraint system, [97](#)
Child safety, [58](#), [97](#), [97](#), [319](#)
Child seats, [97](#), [103](#)
Cleaning: vehicle interior, [342](#)
Closing/Opening the doors, [54](#)
Closing/Opening the luggage compartment, [54](#)
Closing/Opening the sunroof, [54](#)
Closing the doors, [63](#)
Configuration menu, [136](#)
Coolant level, [335](#)
Cruise control, [251](#), [255](#)
Cruise control - Speed limiter, [251](#)
Customising the vehicle settings, [136](#)

D

Daytime running lights, [356](#)
Detection of road signs, [229](#), [229](#)
Digital key, [60](#)
Dipped beam headlights, [356](#)
Direction indicator lights, [356](#)
Direction indicators, [356](#)
Display, [133](#)
Doors, [63](#), [67](#)
Doors/Luggage compartment door, [54](#), [58](#)
Driver assistance, [197](#), [211](#), [216](#), [229](#), [281](#), [286](#)
Driver vigilance warning, [227](#)

Driving, [167](#), [179](#), [185](#), [187](#), [192](#), [197](#), [211](#), [216](#), [251](#), [255](#), [281](#), [286](#)
Driving advice, [183](#), [183](#), [185](#)
Driving aids, [197](#), [211](#), [216](#), [229](#), [233](#), [248](#), [255](#), [281](#), [286](#), [294](#)
Driving position, [120](#)
Driving position: settings, [84](#)

E

ECO driving, [183](#), [183](#), [183](#)
Electrical adjustment of the dipped beam headlights, [156](#)
Electric vehicle: driving, [185](#)
Electric vehicle: introduction, [20](#)
Electric vehicle: vehicle range, [185](#)
Electric windows, [319](#)
Electronic parking brake, [177](#), [179](#)
Electronic stability control: ESC, [192](#)
Emergency brake assist, [192](#)
Emergency braking, [192](#)
Engine identification, [372](#)
Engine specifications, [372](#)
Environment, [182](#)
ESC : electronic stability control, [192](#)
Excessive speed warning, [229](#)
Exterior lighting and signals, [152](#)
Exterior lights, [356](#)

F

Fitting a child seat, [103](#)

ALPHABETICAL INDEX

Front headrests, [75](#)
Front seat adjustment, [75](#)
Front seat belt pretensioners, [88](#)
Front seats, [75](#)
Front seats: adjustment, [75](#), [84](#)
Fuses, [361](#)

G

Gear control, [170](#)

H

Hands-free parking, [281](#)
Hands-free telephone integrated control, [317](#)
Headlight beam adjustment, [156](#)
Headlights: adjustment, [156](#)
Headrests, [82](#)
Heating and air conditioning system, [305](#)
Heating system, [305](#)

I

Ignition switch, [179](#)
Indicators, [356](#)
Instrument panel, [179](#), [187](#)
Instrument panel warning lights, [179](#)
Interior lighting, [321](#)
Interior lighting: changing bulbs, [357](#)
Interior trim: maintenance, [342](#), [342](#)

L

Lane Centring, [233](#)
Lane departure prevention, [197](#)
Lane departure warning, [197](#)
Levels, [333](#), [336](#)
Levels: coolant, [335](#)
Lighting signals, [156](#)
Lights: adjustment, [156](#)
Lights: replacing bulbs, [356](#)
Locking/unlocking the doors, [58](#), [64](#)
Locking the doors, [54](#), [58](#)
Luggage compartment, [68](#)

M

Main beam headlights, [356](#)
Maintenance: bodywork, [340](#), [340](#)
Maintenance: filters, [336](#)
Maintenance: interior trim, [342](#), [342](#)
Messages on the instrument panel, [179](#), [187](#)
Methods of restraint in addition to the front seat belts, [88](#)
Multifunction screen, [211](#)
Multimedia (equipment), [317](#)
Multimedia equipment, [317](#)
Multimedia screen, [216](#), [286](#), [294](#)
Multi-Sense, [304](#)

N

Navigation, [317](#)

ALPHABETICAL INDEX

Navigation system, [317](#)

O

Opening element/door controls, [54](#)

Opening elements, [54](#), [63](#), [67](#)

Opening the doors, [63](#)

Operating faults, [255](#), [294](#)

Operating faults: card batteries, [52](#)

P

Paintwork: maintenance, [340](#)

Park Assist: assisted parking, [281](#)

Parking: park assist, [294](#)

Parking brake, [177](#), [179](#)

Parking distance control, [272](#), [278](#)

Passenger safety: front passenger airbag, [117](#)

Pedestrian horn, [20](#)

Phone, [317](#)

Power consumption, [133](#), [185](#)

Power range, [183](#)

Power saving, [183](#), [185](#)

Practical advice, [185](#)

Pretensioners, [88](#)

R

Radio, [317](#)

Rear headrests, [82](#)

Rear seats, [82](#)

Rear view mirrors, [146](#)

Replacement and repair parts, [378](#)

Replacing windscreen wiper blades, [359](#)

Restraint devices in addition to the rear seat belts, [88](#), [93](#)

Restraint in addition to the seatbelts, [88](#), [93](#)

Reversing camera, [278](#), [278](#)

Roof bars, [331](#)

S

Safe distance, [255](#)

Safe distance alert, [216](#)

Safe distances, [216](#)

Safe passenger exit, [297](#)

Seat belt pretensioners, [88](#)

Seat belts, [84](#), [88](#)

Seats: adjustment, [77](#)

Seats: front seats with electric controls, [77](#)

Seats: heated, [77](#)

See-me-home lighting, [156](#)

Settings, [136](#)

Settings: configuration menu, [136](#)

Side protection devices, [93](#)

Speed limiter, [251](#)

Starting, [167](#)

Starting the engine, [167](#), [167](#), [167](#)

Steering wheel: adjustment, [144](#)

Stopping the engine, [167](#), [179](#)

Storage compartment/ fittings: passenger compartment, [324](#)

ALPHABETICAL INDEX

T

Wiper blades: replacement, [359](#)

Tools, [351](#)

Towing: breakdown, [353](#)

Towing rings, [353](#)

Traction battery, [20](#)

Traction battery range, [183](#)

Traction control, [192](#)

Transporting children, [97](#)

Trip computer, [126](#)

Troubleshooting: towing the vehicle, [353](#)

Tyre inflation, [187](#)

Tyre inflation kit, [187](#), [347](#), [347](#)

Tyre pressure, [187](#), [346](#)

Tyre pressure loss warning, [187](#)

Tyres, [187](#), [344](#), [344](#)

V

Vehicle customisation settings, [136](#)

Vehicle range, [183](#), [185](#)

Vehicle settings personalisation menu, [136](#)

Vehicle weights, [376](#)

W

Warning: parking exit, [294](#)

Warning lights, [211](#)

Warning lights on the instrument panel, [187](#)

Washing, [340](#)

Wiper, [161](#), [161](#), [164](#)



RENAULT S.A.S. SOCIÉTÉ PAR ACTIONS SIMPLIFIÉE / 122-122 BIS, AVENUE DU GENERAL LECLERC 92100 BOULOGNE-BILLANCOURT R.C.S. NANTERRE 780 129 987 — SIRET 780 129 987 03591 / renaultgroup.com

NU 1531-3 – 77 11 416 669 – 07/2024 – Edition anglaise



7711416669

